

RADIO & TELEVISION NEWS

JANUARY
1953

IN THIS ISSUE

TELEMETERING SYSTEMS

ELECTRONIC DEFIBRILLATOR

VERSATILE D.C. AMPLIFIER

**THE NBS
PRIMARY FREQUENCY STANDARD**

FREQUENCY CALIBRATOR

RECORDER-REPRODUCER

**OSCILLOSCOPES
THE ELECTRONIC EYE OF THE
SERVICE TECHNICIAN**

"TWO-METER MASTER"

AMPLIFIER FOR \$20

"TELEVISION TODAY'S NEWS" ▶

(See Page 55)



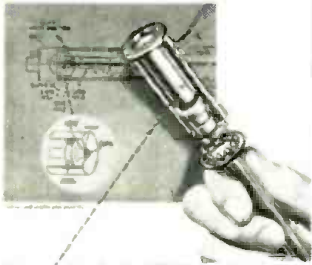

The gun that looked 100% "perfect" ... yet never "fired a shot"

... yet never "fired a shot"

RCA RADIO CORPORATION of AMERICA
ELECTRON TUBES



How we spot "shady characters" before they can damage your business

... before they can damage your business

RCA RADIO CORPORATION of AMERICA
ELECTRON TUBES

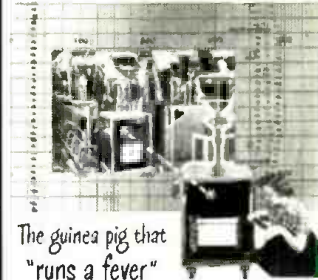

The guinea pig that "runs a fever" to bring you better picture tubes

... to bring you better picture tubes

RCA RADIO CORPORATION of AMERICA
ELECTRON TUBES

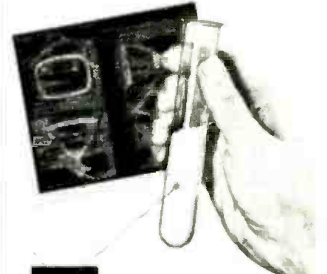

99.9% pure phosphor... yet we threw it away

... yet we threw it away

RCA RADIO CORPORATION of AMERICA
ELECTRON TUBES

The evidence is clear...

RCA safeguards your reputation... with tubes of unequalled quality

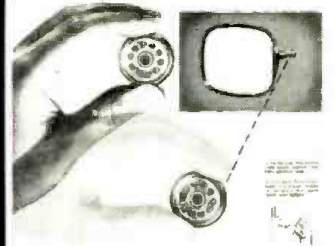

A DOUBLE-TAKE to safeguard your reputation

... to safeguard your reputation

RCA RADIO CORPORATION of AMERICA
ELECTRON TUBES

In RCA Tubes and Kinescopes the difference is top-quality control



RADIO CORPORATION of AMERICA
ELECTRON TUBES

HARRISON, N. J.

TMK. ®

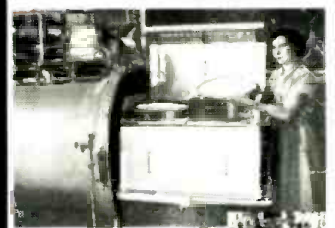

The Torture Chamber that tests the strength of RCA Picture Tubes

... that tests the strength of RCA Picture Tubes

RCA RADIO CORPORATION of AMERICA
ELECTRON TUBES

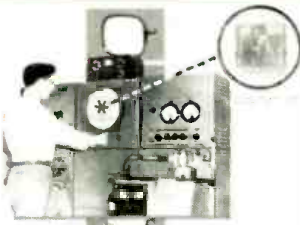

How we get "after" that's just right for RCA picture-tube screens

... that's just right for RCA picture-tube screens

RCA RADIO CORPORATION of AMERICA
ELECTRON TUBES



Quality control by feedback ... the secret of RCA tube performance

... the secret of RCA tube performance

RCA RADIO CORPORATION of AMERICA
ELECTRON TUBES

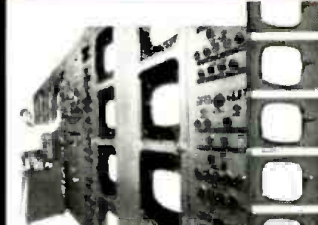

The Million-Dollar Test Equipment that pays off in better picture tubes

... that pays off in better picture tubes

RCA RADIO CORPORATION of AMERICA
ELECTRON TUBES

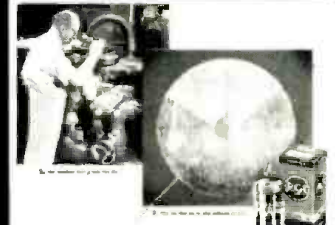

Take a look at quality being born

... quality being born

RCA RADIO CORPORATION of AMERICA
ELECTRON TUBES

For faithful tone reproduction . . . high fidelity at low volume level — use Centralab's Compentrol

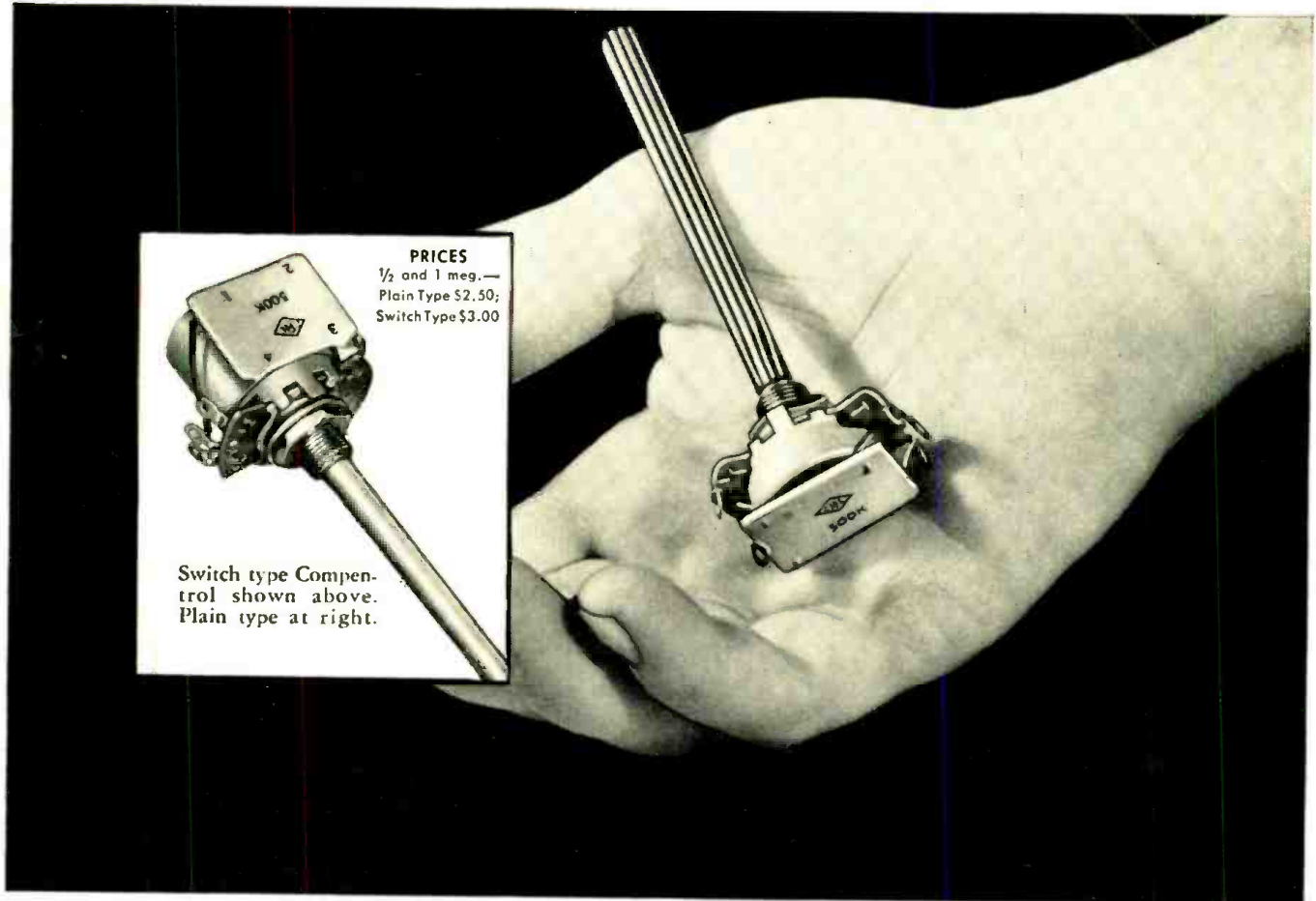

PRICES
 1/2 and 1 meg.—
 Plain Type \$2.50;
 Switch Type \$3.00

Switch type Compentrol shown above. Plain type at right.

Centralab components are safest for guaranteed servicing

You can stake your service reputation on the Centralab Compentrol. That's because this combination volume control and Printed Electronic Circuit faithfully reproduces the high-pitched tones of the operatic soprano — or the deep bass notes of the boogie woogie beat . . . when volume is set at low level.

In fact, Compentrol was especially developed to better reproduce the apparent bass and treble response of radios, audio amplifiers, phonograph combinations and television sets. Use it as a business builder as well as for replacement service. It actually improves original performance! What's more, its low price will fit any pocketbook.

Because of its design CRL's Compentrol needs *no additional amplification*. There is no insertion loss when you use Compentrol.

The Centralab Compentrol is furnished in 1/2 or 1 meg.—plain or switch types. Switch is SPST, and an insulated switch shield is furnished for a-c shielding. Most amplifiers use a plain type. For complete details, ask your Centralab distributor, or use the coupon.

Make your Centralab distributor headquarters for exact electronic replacements

Centralab

A Division of Globe-Union Inc.
 Milwaukee 1, Wisconsin
 In Canada, 635 Queen Street East, Toronto, Ontario

The Centralab Compentrol is only one of the more than 470 *new* items listed in Centralab's new Catalog 28. Get your copy of this 32-page index to the latest developments in the fast-changing electronic field, plus a 16-page booklet telling the whole Compentrol story. See your distributor or use the coupon.



CENTRALAB, A Division of Globe-Union Inc.
 910 E. Keefe Ave., Milwaukee 1, Wis.

Please send me my copy of the new Compentrol Booklet as well as Centralab Catalog 28 at once and without charge.

Name.....Position.....
 Company.....
 Address.....
 City.....State.....

RADIO & TELEVISION NEWS is published monthly by the Ziff-Davis Publishing Company at 185 N. Wabash Ave., Chicago 1, Ill. Entered as second-class matter, July 21, 1948, at the Post Office, Chicago, Ill., under the act of March 3, 1879. Authorized by Post Office Department, Ottawa, Canada, as second-class matter. SUBSCRIPTION RATES: Radio & Television News—one year, U. S. and Possessions, Pan-American countries, and Canada \$4.00; all other foreign countries \$5.00; Radio-Electronic Engineering Edition—one year, U. S. and Possessions, Pan-American countries, and Canada \$6.00; all other foreign countries \$7.00. Postmaster—Please return undelivered copies under form 3580 to 64 E. Lake St., Chicago 1, Ill.

Editor
OLIVER READ, D.Sc., WIETI

Managing Editor
WM. A. STOCKLIN, B.S.

Technical Editor
H. S. RENNE, M.S.

Service Editor
CHARLES TEPFER

Assistant Editors
P. B. HOEFER
M. C. MAGNA

Television Consultant
WALTER H. BUCHSBAUM

Short-Wave Editor
KENNETH R. BOORD

Staff Artist
FRANK SAYLES

Draftsman
A. A. GANS, W2TSP

Advertising Manager
L. L. OSTEN

Midwest Adv. Manager
JOHN A. RONAN, JR.

Western Adv. Manager
JOHN E. PAYNE



COVER PHOTO: John Cameron Swayze faces the NBC television cameras for his daily stint on the "Camel News Caravan." This program, featuring both live and film pickups, calls for split second timing and careful coordination. (Ektachrome by Art Selby)

Chairman of the Board and Publisher
WILLIAM B. ZIFF

President
B. G. DAVIS

Secretary-Treasurer
G. E. CARNEY

Vice-Presidents
H. J. MORGANROTH
Production Director

LYNN PHILLIPS, JR.
Advertising Director

H. G. STRONG
Circulation Director

BRANCH OFFICES

CHICAGO (11)
 185 N. Wabash, AN 3-5200
 LOS ANGELES (14)

Stoller Center, 900 Wilshire Blvd., Mich. 9856

RADIO & TELEVISION NEWS

Reg. U.S. Pat. Off.

First in
radio-television-electronics
 Average Paid Circulation over 220,000

Radio News Trademark Reg. U. S. Pat. Office • Television News Trademark Reg. U. S. Pat. Office.

CONTENTS

JANUARY, 1953

Oscilloscopes—the Electronic Eye of the Service Technician.....	Milton S. Kiver	31
A Photoelectric Headlight Dimmer.....	Peter J. Vogelgesang	35
U.H.F. Antennas (Part 2).....	Milton S. Kiver	36
The "Two-Meter Master".....	Rob Wagner, W6WGD	39
Demagnetizer.....	Matthew Mandl	42
An Amplifier for \$20.....	Arnold J. Gassan	44
New Designs for 1953.....	Walter H. Buchsbaum	46
A Vibration-Pickup Amplifier.....	Louis E. Garner, Jr.	48
Signal Tracing in High-Voltage TV Circuits.....	Art Liebscher	50
A Better Electronic Key.....	Jack D. Gallagher, W5HZB	52
Televising Today's News.....	Ralph Howard Peterson	55
Phase-Shift Tone Controls.....	Glen Southworth	56
Modernizing the SCR-274/N Transmitter.....	Carl V. Hays, W6RTP	58
Mac's Radio Service Shop.....	John T. Frye	60
A Low-Cost Audio Oscillator.....	C. R. Gerber	62
25-Watt Utility Unit.....	George Anglado	66
Radio-TV Service Industry News.....		146

DEPARTMENTS

For the Record.....	The Editor	8	Short-Wave.....	K. R. Boord	61
Spot Radio News.....		16	Manufacturers' Literature.....		106
Within the Industry.....		24	What's New in Radio.....		116
			New TV Products.....		130



COPYRIGHT 1952
ZIFF-DAVIS PUBLISHING COMPANY
 Editorial and Executive Offices
 366 Madison Ave., New York 17, N. Y.
 VOLUME 49 • NUMBER 1



Member
 Audit Bureau of
 Circulations

SUBSCRIPTION SERVICE: All communications concerning subscriptions should be addressed to Circulation Dept., 64 E. Lake St., Chicago 3, Ill. Subscribers should allow at least two weeks for change of address.

CONTRIBUTIONS: Contributors are advised to retain a copy of their manuscripts and illustrations. Contributions should be mailed to the New York Editorial Office and must be accompanied by return postage. Contributions will be handled with reasonable care, but this magazine assumes no responsibility for their safety. Any copy accepted is subject to whatever adaptations and revisions are necessary to meet the requirements of this publication. Payment covers all author's, contributor's, and contestant's rights, title, and interest in and to the material accepted and will be made at our current rates upon acceptance. All photos and drawings will be considered as part of the material purchased.

RADIO & TELEVISION NEWS

Prepare Now... in spare time at Home ... for a New,

PROFITABLE, INTERESTING FUTURE



TELEVISION
RADIO - ELECTRONICS

RADIO CHIEF OF ILE DE FRANCE
FRENCH LUXURY LINER PRAISES D. T. I.

Radio Chief—Jean Desmas Says:

"DeForest's Training, Inc., of Chicago, is known not only throughout Europe, but also in many parts of the world as one of America's finest Television, Radio and Electronics training centers."



JACK DEMPSEY

Former World's Heavyweight Champion
TELLS WHY HE'S PROUD
TO BE WITH **D.T. I.**

- I have been greatly impressed with D.T.I.'s wonderful spirit of friendliness and sincere determination to help its students make good in Television-Radio-Electronics.
- I admire its remarkable 20 year record of helping men build brighter futures.
- I also admire the business policy of its management and the thoroughness of its large faculty of instructors.
- Never have I heard young men praise a school as enthusiastically as do the students and graduates of D.T.I. They are its best boosters.

Prepare At Home Or In Our Chicago Laboratory!

See for yourself how readily you may prepare at home, or in our modern Chicago laboratories, for a better job or business of your own in one of America's fastest-growing fields—TELEVISION-RADIO-ELECTRONICS.

If you train at home you get (1) the use of a 16-mm. movie projector and 16 reels of animated movies to help you learn important points faster . . . easier, (2) modern lessons and (3) sixteen shipments of electronic parts enabling you to get valuable practical experience from over 300 projects—including building and keeping the electronic equipment shown below. And upon completing training, you have the optional privilege of building and keeping a big 17-INCH TV set at moderate added cost. Get the full story. Mail coupon today!

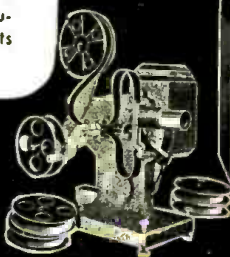

HOME MOVIES



MULTIMETER

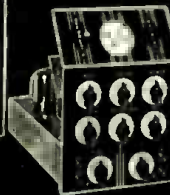

OSCILLOSCOPE



R-F SIGNAL GENERATOR



6-TUBE RADIO

LAUD D. T. I.'s HOME MOVIES IN CONGRESS

D.T.I.'s remarkable home training benefit of visual training MOVIES has been praised from the floor of the House of Representatives in Washington, D. C. and recorded in The Congressional Record.



MILITARY SERVICE!

If subject to military service, the information we have for you should prove very helpful. Mail coupon today.



De FOREST'S TRAINING, INC.
AFFILIATED WITH
De VRY Technical INSTITUTE
CHICAGO 14, ILLINOIS



MAIL COUPON TODAY!

Dept. RN-1-J
DE FOREST'S TRAINING, INC.
2533 N. Ashland Ave., Chicago 14, Ill.

I would like your Opportunity News Bulletin showing "89 Ways to Earn Money in Television-Radio-Electronics"; also, the folder showing how I may prepare to get started in this thrilling field.

Name _____ Age _____
Address _____ Apt. _____
City _____ Zone _____ State _____

performance proven!



Vee-D-X takes the lead in UHF antennas—just as it did in VHF. Whatever the area—single channel, multi-channel, combination UHF-VFH, primary or fringe—there's a performance proven VEE-D-X antenna or combination of antennas that will provide brilliant reception. All Vee-D-X antennas for UHF were developed and extensively field-tested with the experimental UHF transmitter (KC2XAK) located at Bridgeport, Connecticut (since 1949)—and only 60 miles from the Vee-D-X development laboratory. So, be safe—be sure with Vee-D-X performance—proven UHF antennas.

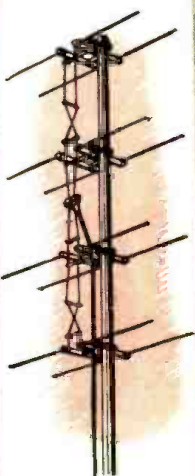

THE UHF COLINEAR

A high gain all-channel fringe area antenna. Here is the mighty mite of all-channel UHF reception and considered by a leading TV set manufacturer as the finest UHF antenna yet perfected. Rugged four-bay construction of solid aluminum elements with fiberglass cross arms. List \$11.10 Also available in side-by-side stack.



THE YAGI

UHF Yagis for primary and fringe areas in two models—an all-aluminum eight-element and a twelve-element with special weather-resistant fiberglass boom. Both antennas provide high gain and wide band width. Model LJ-U \$6.15 List Model LLJ-U \$7.65 List

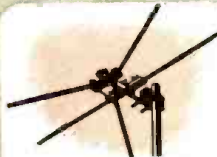

THE VEE-D-X "V"

All-channel primary area antenna. Excellent broad band characteristics. Supplied as a straight UHF antenna or with Vee-D-X Mighty Match for use in combination with a VHF antenna using a single transmission line. The plain "V" lists \$2.75



VEE-D-X UHF ADAPTING BRACKET

Permits addition of UHF antenna to existing VHF installation. Can be mounted three different ways to mast or antenna boom. Fast, easy, inexpensive to install. Supplied plain (list \$1.50) or with Mighty Match MM-30 list (\$5.50)

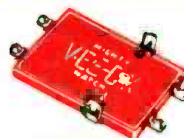

VEE-D-X MIGHTY MATCH (Model MM-30)

Provides a most efficient method of combining VHF-UHF antenna systems with a single transmission line. Entirely automatic in action. Employs new printed circuit filters. List \$4.00

VEE-D-X ALL-CHANNEL UHF-VHF ANTENNAS

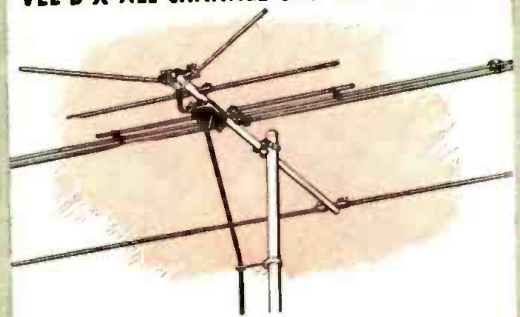

The Ultra Q-Tee

THE ULTRA Q-TEE and its new companion the ULTRA Q-TEE Suburban combine both UHF and VHF into a single antenna using a single transmission line. Both contain eight patented* printed circuit channel separators. The Ultra Q-Tee is designed for primary areas and will receive all channels 2-83 VHF-UHF. Lists for \$14.25

*Lic. A.A. K. Pats. 2,422,458; 2,282,292; 2,611,086; others pending.

The Ultra Q-Tee Suburban



THE ULTRA Q-TEE SUBURBAN is designed for all-channel VHF and fringe area UHF. Lists for only \$17.60

FREE!

UHF ANTENNA GUIDE

An authentic guide to UHF antenna systems. For your copy, write the LaPointe-Plascomold Corp., Rockville, Conn.



NOW hallicrafters

HIGH FIDELITY AM/FM TUNER AND AMPLIFIER

Helps You Cash in on the Fastest Growing Market in Home Music!



At last, high-fidelity units with a name your customers know and respect. Hallicrafters, world-recognized as the leader in precision radio equipment, now brings you high-fidelity equipment second to none—at realistic prices that are easy to sell—insure a fair profit.

The high-fidelity market is a rapidly expanding market—for the last four years sales of high-fidelity equipment *have more than doubled each year!*

Get your share of this high profit business with the equipment your customers know and respect—*Hallicrafters!*



HALLICRAFTERS AM/FM TUNER ST-83

Completely encased for table use or custom installation. Underwriters' Laboratory approved. Input jacks for phonograph, tape recorder, television, etc. This tuner enables the listener to hear every sound audible to the human ear—it has an accuracy of reproduction second to none.

Retails at \$129.50



HALLICRAFTERS AMPLIFIER A-84

Guaranteed frequency range is 10 to 100,000 cycles per second at 10 watts. A completely new output transformer gives the widest range ever produced. Harmonic distortion is less than 0.25% at 10 watts output. The amplifier, like the tuner, is completely encased and has Underwriters' Laboratory approval.

Retails at \$99.50

*World's Leading
Manufacturer of Precision-Built
Radio and Television*

hallicrafters

For the RECORD.

BY THE EDITOR

THE MAGIC OF GERMANIUM AND PRINTED WIRES

THE year 1953 will, without a doubt, usher in a new concept of electronic circuitry made possible by man's ability to utilize tiny specks of germanium crystal. Progress in the development of the transistor has been remarkable in recent months. The transistor has emerged from the laboratory into the realm of mass production—all within the span of four short years.

No longer is it necessary to spend a day's salary or to stand in line to purchase one of these pea-sized electronic wonders. Now available in quantity are commercial-quality transistors which are capable of performing many of the functions of the vacuum tube.

Take, for example, the conventional hearing aid with its three subminiature vacuum tubes and its other components all housed in a case slightly smaller than a pack of cigarettes. Now, visualize this same instrument using transistors and printed circuitry in a case no larger than a cigar lighter and one can readily appreciate the tremendous possibilities for ultra-compact electronic devices.

It takes little imagination to visualize a complete radio receiver contained in a fountain pen case or an audio amplifier built inside of a phono pickup arm; even "Dick Tracy's" wristwatch transceiver looms as a practical commercial product rather than the figment of a cartoonist's imagination.

In order to become familiar with the transistor, one must not only read the literature and study the theory and applications of the device but he must experiment with the circuitry and use the transistor in workable equipment. This publication has, in past articles, set the stage for a complete understanding of the transistor—its applications and limitations. Logically, the next step is to show "how to use" the transistor in a series of home experiments with construction details supplied for building several receivers, transmitters, audio amplifiers, and television circuits.

It is our hope to bring you the first details on the use of transistors in electronic equipment in a series of practical articles scheduled to begin in the February issue of RADIO & TELEVISION NEWS, or as soon thereafter as possible. Several working units are now under test in our lab.

The year 1953 will find an ever-increasing acceptance of printed circuit techniques and applications. The development of printed circuitry has, like the transistor, emerged from the drafting board stage and has become an accepted circuit technique. Never before in the history of electronics have two developments (the transistor and printed circuits) been better suited for a happy marriage.

The experts are now anticipating a tremendous field of applications that will probably require an annual production of transistors in the billions. Crystal diodes, too, are finding almost unlimited fields of conquest. These germanium devices, now widely used in television circuitry, have done much to speed the development of mass production techniques of the transistor.

Although these tiny germanium devices do open the door to many new electronic applications it is doubtful that they will eventually replace the vacuum tube entirely. Further knowledge and control of the characteristics of transistors is essential before the engineer can fully appreciate their future potential.

Students and technicians of today have a wonderful opportunity for experimenting with transistors in many different types of devices. These experimenters will discover new applications for the transistor in the fields of medicine, commercial radio, audio, industrial devices, and communications.

Today we stand at the threshold of a new era in electronics—one made possible by man's discovery and control of germanium crystals. The door is open to new and greater opportunities for those who know and understand these revolutionary techniques. . . . O. R.

As we go to press, we have just witnessed a demonstration of transistor techniques, sponsored by RCA. See page 122 for further details.

RADIO & TELEVISION NEWS

EV

for PA
LIKE ON TV

636
Slimair
**DYNAMIC
MICROPHONE**

Gives you features similar to those in the famous E-V Slim-Trim TV Microphones. That's why it is so outstanding for Public Address, Recording and other general-purpose use.
List Price \$70

SMOOTH RESPONSE
60-13,000 CPS
HIGH OUTPUT
OMNIDIRECTIONAL
ACOUSTALLOY
DIAPHRAGM
BUILT-IN
BLAST FILTER

Can be used
in the hand,
on a stand,
or overhead

SEND FOR BULLETIN

Electro-Voice
410 CARROLL ST. • BUCHANAN, MICH.
Export: 13 E. 40th St., N. Y. 16, U.S.A.

**THE ONLY COMPLETE CATALOG FOR
EVERYTHING IN TV, RADIO AND
INDUSTRIAL ELECTRONICS**

get your 1953 **FREE**

ALLIED

236-PAGE CATALOG

**it's complete
it's value-packed**

THE WORLD'S LARGEST STOCKS

- TV and Radio Parts
- Test Instruments
- Hi-Fi and P.A. Equipment
- Custom TV Chassis
- AM, FM Tuners & Radios
- Recorders and Supplies
- Amateur Station Gear
- Builders Supplies
- Equipment for Industry

**QUICK
EXPERT
SERVICE**



Send for it today!

Here's the *one* authoritative, complete Buying Guide to *Everything in Electronics*—packed with the world's largest selections of quality equipment at lowest money-saving prices. See the latest in TV custom chassis, TV antennas and accessories; AM and FM tuners and radios; High-Fidelity Custom Sound components; latest P.A. Systems and accessories; recorders; Amateur receivers, transmitters and station gear; specialized industrial electronic equipment; test instruments; builders' kits; huge listings of parts, tubes, tools, books—your choice of the world's *most complete stocks* of quality equipment.

ALLIED gives you every buying advantage; speedy delivery, expert personal help, lowest prices, liberal time payment terms, assured satisfaction. Get the latest 1953 ALLIED Catalog. Keep it handy—and save time and money. Send for your **FREE** copy today!

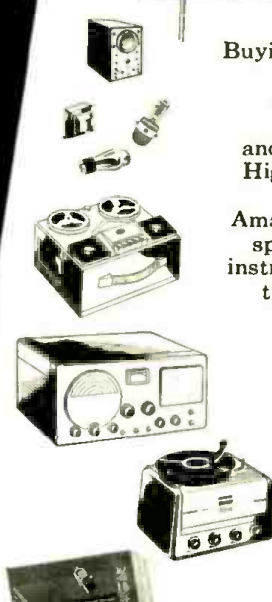

**EVERYTHING IN
ELECTRONICS**

**SEND TODAY FOR RADIO'S
LEADING BUYING GUIDE**

free

ALLIED RADIO
World's Largest Electronic Supply House

EASY-PAY TERMS
Take advantage of ALLIED's liberal Easy Payment Plan—Radio's best terms—only 10% down, 12 months to pay—no interest if you pay in 60 days. Available on Hi-Fi and P. A. units, recorders, TV chassis, test instruments, Amateur gear, etc.

TV & HI-FI SPECIALISTS
To keep up with developments in TV and High-Fidelity, look to ALLIED! Count on us for *all* the latest releases and largest stocks of equipment in these important fields. If it's *anything* in Television or High-Fidelity equipment—we have it in stock!

ALLIED RADIO CORP., Dept. 1-A-3
833 W. Jackson Blvd., Chicago 7, Illinois

Send **FREE** 236-Page 1953 ALLIED Catalog.

Name

Address

City Zone State

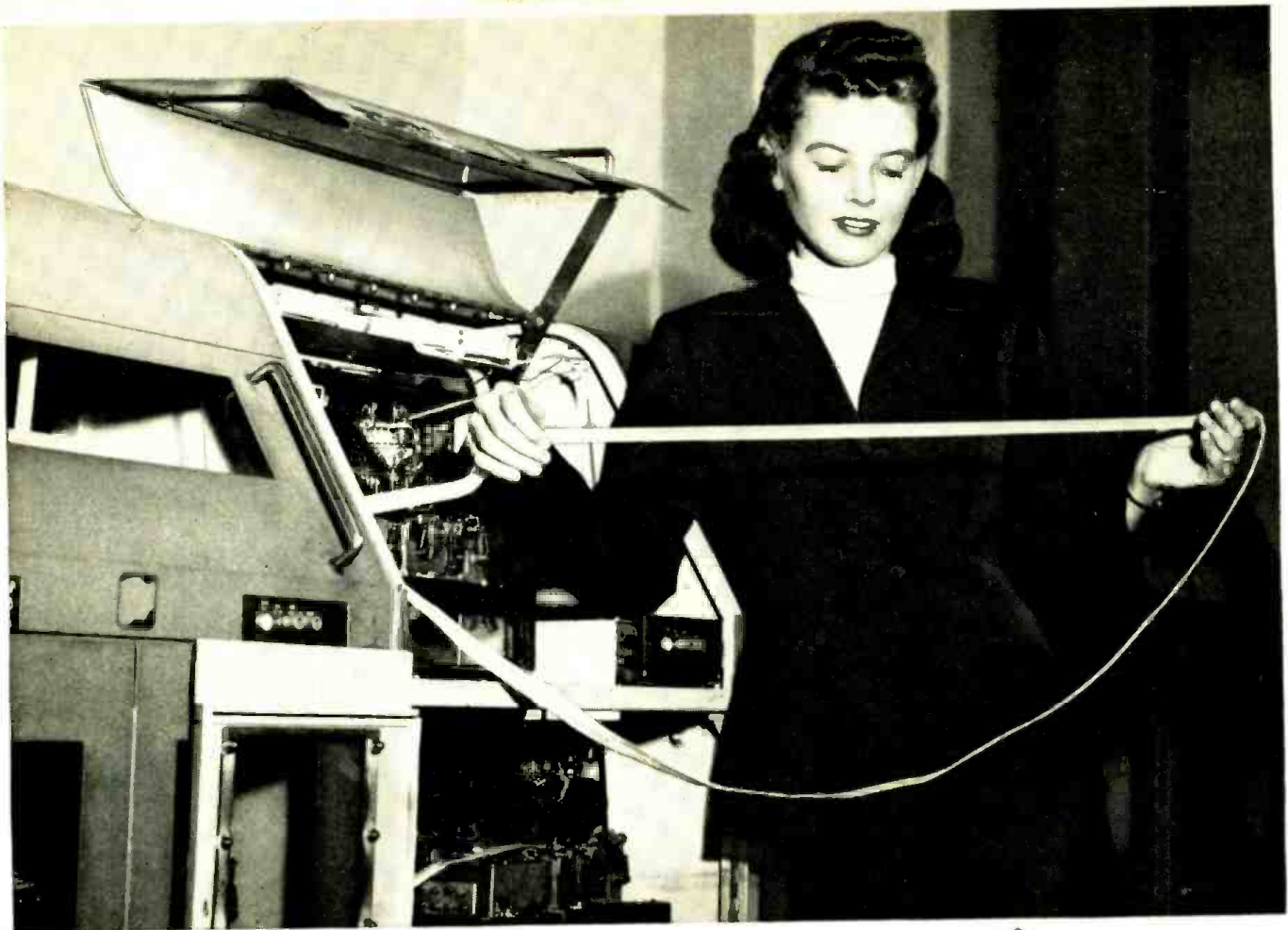

These signals find the way

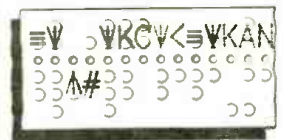

SENDING

When you dial a telephone number, high-speed switching mechanisms select your party and connect you. Through a new development of Bell Telephone Laboratories, similar mechanisms are doing the same kind of job in private wire teletypewriter systems which America's great businesses lease from the telephone company.

Company X, for example, operates an air transportation business with scores of offices all over the country. At one of these offices, a teletypewriter operator wishes to send a message. let us say, to Kansas City. Ahead of the message, she types the code letters "KC". The letters become electric signals which guide the message to its destination.

Any or all stations in a network, or any combination of stations, can be selected. Switching centers may handle 50 or more messages a minute . . . some users send 30,000 messages a day. Delivery time is a few minutes.

Defense manufacturers, automobile makers, airlines and many other American businesses are benefiting by the speed and accuracy of the new equipment — another example of how techniques developed by the Laboratories for telephone use contribute to other Bell System services as well.



RECEIVING



BELL TELEPHONE LABORATORIES

Improving telephone service for America provides careers for creative men in scientific and technical fields.

RADIO & TELEVISION NEWS

Booster performance depends on noise figure!

Gain alone is NOT enough!

CHANNEL MASTER

a new kind of SINGLE CHANNEL TV BOOSTER

with the

Highest gain Lowest noise
in booster history!

- GAIN: 12 Times (22 DB), low band; 8.5 Times (18.6 DB), high band.
- NOISE: 4.5 DB, low band; 6.5 DB, high band.
- The only single channel booster with CASCODE-type CIRCUIT
 - Uses famous, low-noise 6BQ7 tube.
- Double-tuned transformers for peaking both video and sound.
 - Antenna by-pass switch.

Actual Performance Figures prove that Katy-B tops 3 leading boosters!

	KATY-B	Booster A	Booster B	Booster C
Gain (high no. preferred)	8.5 Times	4.2 Times	5.9 Times	6.2 Times
Noise (low no. preferred)	6.5	14.3	8	9.1
VSWR (low ratio preferred)	1.5:1	9:1	2.6:1	3.8:1
Balance-to-Unbalance Ratio (high ratio preferred)	10:1	1.4:1	5.8:1	7.1:1

Typical Comparison on Channel 12



list price \$24⁴⁰

TV "snow" is noise generated by the set and booster. The amount of noise present depends primarily upon the first tube in the receiving system.

This means that where a booster is used, the amount of "snow" in the picture depends almost entirely upon the performance of the booster, and the tube(s) it uses. Most single channel boosters on the market today have poorer Noise Figures than modern TV front ends. Therefore, while these boosters may contribute gain, they actually deteriorate picture quality by adding noise.

Katy-B is the first modern single channel booster. It employs the famous, low-noise 6BQ7 tube in a Cascode-type circuit, which gives the lowest Noise Figure and highest gain ever obtained in a television booster.

FREE: Educational new booklet—
"The 4 Standards of Booster Performance"

Ask your Channel Master distributor
for your copy.



CHANNEL MASTER CORP.

ELLENVILLE, N. Y.



The 7" TV scope for professionals

RCA WO-56A

DUAL CONTROLS FOR "COARSE" AND "FINE" ADJUSTMENTS

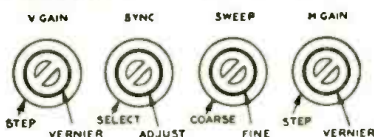

No hunting or fumbling for controls when adjusting Vertical Amplifier Gain, Sweep Frequency, Sync Injection, and Horizontal Amplifier Gain.



FEATURING—

- Giant 7-inch cathode-ray tube.
- Direct-coupled, 3-stage, push-pull, vertical and horizontal amplifiers.
- Frequency-compensated and voltage calibrated attenuators on both amplifiers.
- A set of matched probes and cables.
- Panel-source of 3 volts peak-to-peak calibrating voltage.
- Identical vertical and horizontal amplifiers with equal phase-shift characteristics.
- Retractable light shield for convenience and visibility.
- New green graph screen with finely ruled calibrations.
- Magnetic metal shield enclosing CR tube to minimize hum-pickup from stray fields.

SPECIFICATIONS—

- Deflection Sensitivity: 10 rms millivolts per inch.
- Frequency Response: Flat within -2 db from dc to 500 kc; within -6 db at 1 Mc useful response beyond 2 Mc.
- Input Resistance and Capacitance: 10 megohms and 9.5 uuf with low-capacitance probe.
- Square-Wave Response: Zero tilt and overshoot using dc input position. Less than 2% tilt and overshoot using ac input position.
- Linear Sweep: 3 to 30,000 cps with fast retrace.
- Trace Expansion: 3 times screen diameter in vertical and horizontal axis, with 3 times centering control.
- Size 13 3/4" h, 9" w, 16 1/2" d. Weight only 31 pounds (approx.).

ADVANCED SWEEP FACILITIES—

- Preset fixed sweep positions for vertical and horizontal television waveforms.
- Positive and negative syncing for easy lock-in of upright or inverted pulse waveforms.
- 60-cycle phase-controlled sweep and synchronizing.

**ONLY
\$217⁵⁰**

Suggested
User Price

Complete with direct probe, 10-megohm low-capacitance probe, and ground cable.

Built for laboratory, factory, or shop use, the WO-56A combines the advantages of high-sensitivity and wide-frequency range in a *very small* instrument with a *large* cathode-ray tube.

Designed with the user in mind, this new 'scope can be depended upon to provide sharp, bright, large, and accurate pictures of minute voltage waveforms over the entire useful surface of the CRT screen.

The direct-coupled amplifiers are provided with ac positions so that measurements can be made with or without the effects of any dc component.

Square-wave reproduction is excellent, whether the application is low-frequency TV sweep-alignment or observation of high-frequency steep-fronted sync and deflection waveforms.

The excellent linearity and fast retrace of the sweep or time base are functions of the Potter-type oscillator and the undistorted reproduction of the sawtooth by the wide-band horizontal amplifier. The preset fixed positions provide rapid switching between vertical and horizontal waveforms in TV circuits.

Truly, the WO-56A is a most useful and practical instrument for everyday work in the fields of television, radio, ultra-sonics, audio, and a wide array of industrial applications.

For details, see your **RCA Distributor**, or write RCA, Commercial Engineering, Section 52AX, Harrison, N. J.



RADIO CORPORATION of AMERICA
TEST EQUIPMENT
HARRISON, N. J.

RADIO & TELEVISION NEWS



EARN MORE MONEY AS AN EXPERT

Get Shop-Method
Training at Home in

RADIO TELEVISION ELECTRONICS

One Master Course - One Low Tuition

LEARN ALL PHASES - EARN WHILE YOU LEARN

AS A NATIONAL SCHOOLS GRADUATE THERE'S A PLACE FOR YOU IN THIS EXPANDING INDUSTRY...*Never before* such a demand for you! For *never before* such a *growing* industry as today's Television, Radio and other Electronic fields. This industry needs you... TODAY... and it needs you as a *trained* man... the kind of man you will be as a National Schools graduate. So don't wait. Start your National Schools training NOW...and enjoy big money, job security, SUCCESS!

LEARN from EXPERTS! BE A SUCCESSFUL MAN YOURSELF! You learn from men who are themselves successful Radio, Television and Electronics technicians. You learn the *practical* way... by *doing*... with equipment we send you. **And you advance quickly, step by step.** Get ALL the facts from **FREE** book and sample lesson. Mail coupon below **NOW**. Absolutely no obligation.



All yours at no extra cost!

Don't put it off! Mail coupon NOW!

You can qualify FAST for these big-pay jobs...plus many more

Radio Station Technician • Your own Sales and Service Shop • District Service Manager • Inspector Technician • Aircraft Radio Inspector • Special Govt. Positions • Service Specialist • Sound Truck Operator • and many others!

ONLY NATIONAL SCHOOLS GIVES YOU THIS PROFESSIONAL MULTI-TESTER



Ready to use. Easy to operate. Light enough to carry on service calls.

DRAFT AGE? National Schools training helps you get into special service classifications—get higher grades, better pay!

GET YOUR TRAINING FROM THE RADIO-TV CAPITAL OF THE WORLD

Let National Schools—a *resident* technical trade school for nearly 50 years—train you at home for today's unlimited opportunities in Radio-TV.



FREE!

Radio-TV Book & Sample Lesson JUST MAIL COUPON!

NATIONAL SCHOOLS GRADUATES IN BIG DEMAND. You'll find National Schools graduates in good jobs everywhere. For these are the jobs National Schools *trains* you for. Such complete, shop-method home training can be *your* ticket to success...your key to the job happiness you've always wanted. It's up to you. Mail coupon NOW!

FRIENDLY GUIDANCE AS STUDENT AND GRADUATE. Our special Welfare Department is constantly at your service. Helps you with your technical and personal problems. Gives you the benefit of its wide industry contacts and experience in helping you after graduation. Write National Schools, 4000 South Figueroa St., Los Angeles 37, California.

NATIONAL SCHOOLS APPROVED FOR G. I. TRAINING

Los Angeles, Calif. • Est. 1905 • In Canada: 193 Hastings St., Vancouver, B.C.

YOU GET ALL THE PARTS INCLUDING TUBES for this superheterodyne receiver... and lots of other equipment...to keep!

NATIONAL SCHOOLS, Dept. RH-13
4000 South Figueroa Street
Los Angeles 37, California

Mail in envelope or paste on postal card

Send me **FREE** book "My Future in Radio-Television and Electronics." Also a **FREE** sample lesson. I understand no salesman will call on me and that there is no obligation.

NAME _____ AGE _____

ADDRESS _____

CITY _____ ZONE _____ STATE _____

VETS! Check here if you are a veteran.

ACT NOW

JFD UHF Corner Reflector No. UHF400



JFD UHF Ultra V-Beam No. UHF500



JFD UHF YAGIS No. UHF300 Series for Channels 14 to 83



JFD UHF "Double-Fee" No. UHF100



JFD UHF "Boutie-Flector" No. UHF600



JFD UHF Rhombic No. UHF 200



Be ready for UHF in any location with the first complete antenna line of its kind. Start today to build more profits and customer confidence with new JFD UHF antennas. Write for bulletins 172-6 for full details.

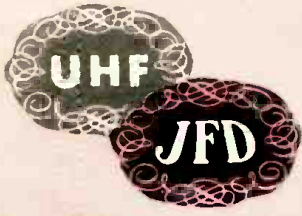

JFD MFG. CO.
BROOKLYN 4, N. Y.
BENSONHURST 6-9200

world's largest manufacturer of
tv antennas and accessories



RECORD COMPENSATOR

"Hit of the New York Audio Fair"

LOW COST

SINGLE HOLE MOUNTING

NEW LIFE FOR OLD RECORDS

EFFECTS FLAT RESPONSE

ADJUSTABLE PLAY BACK

MOUNTS IN ANY POSITION



LP POSITION. The LP (Long Playing) playback response is intended basically for use with Columbia 33 1/2 RPM recordings and modern Columbia 78 RPM shellac pressings. This position is used with any record having the LP recording characteristic.

AES POSITION. The AES (Audio Engineering Society) playback response has been proposed as a compromise response for all modern recordings. It has somewhat greater bass (below 100 cps) and treble response than the LP curve, and may be used in preference to the LP when such increased response is desired. It may be used to advantage with RCA 33, 45, and 78 RPM recordings, and with many other recent recordings.

FLAT POSITION. The flat position has no roll-off or attenuation of response beyond 1000 cps, which results in maximum high frequency response. Records having low background noise and distortion may be reproduced in this position with maximum brilliance. This position has no effect on the circuit, and the corresponding curve is therefore the response curve of the preamplifier and G.E. cartridge (with no cartridge loading resistor) based on constant stylus velocity.

GOOD (early 78). This position is intended for records having a noticeable amount of high frequency distortion or where the background noise is excessive and composed of frequencies higher than those recorded. It is particularly useful for 78 RPM shellac pressings that are in good condition. Brilliance is obtained through the useful portion of the response with sharp attenuation occurring at all frequencies beyond 7500 cps.

POOR (early 78). This position is intended for early 78 RPM shellac records having limited high frequency response and a high noise level. Moderately sharp attenuation occurs at all frequencies above 4000 cps.

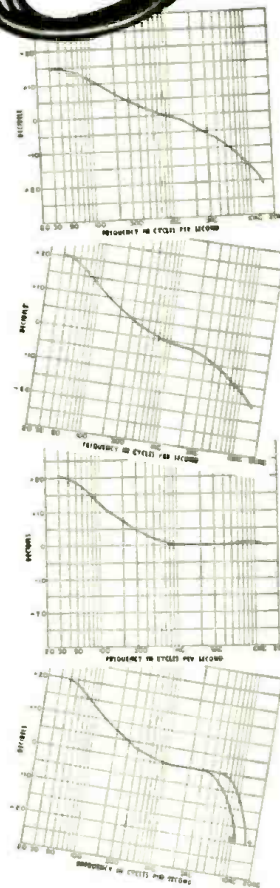

SEND FOR THIS NEW FOLDER...

General Electric Company, Section 913
Electronics Park, Syracuse, N. Y.
Please send me a copy of your Record Compensator ERP-24.

NAME.....
ADDRESS.....
CITY.....STATE.....



GENERAL ELECTRIC

HICKOK

TRUE VTVM

Also measures capacitance

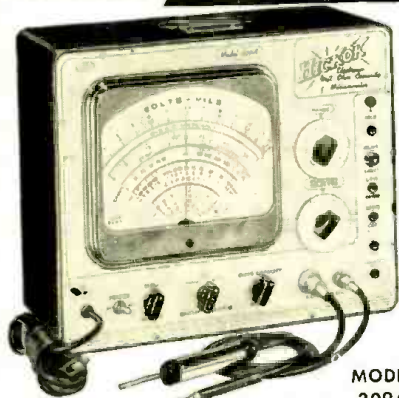

MODEL 209A

- ★ Large 9" Meter Scale
- ★ Zero-Center DC Scale
- ★ Polarity Reversing Switch

Volts, AC-DC and mills DC: 0-1200 in 6 ranges.

Volts, AC, Peak-to-Peak: 0-300 in 5 ranges.

Resistance: 0.1 ohm to 10,000 meg. in 8 ranges.

Capacity: 1 mmf to 1000 mf in 7 ranges.

Current, DC: 5 microamps to 1200 milliamps.

Input Impedance: AC, 3 meg. on 1200 VAC scale. 1200 meg. (shunted by 6 mmf). DC, 12 megohms.

Inductance: 50 mh to 100 henries.

Frequency: 30 cps to 300 megacycles.

Decibels: -20 to +25, in 3 ranges.

Far unexcelled accuracy and dependability, the Model 209A is one of the finest instruments ever built. In addition to being the most reliable VTVM available, complete HICKOK design has included additional features to make the 209A the only true VTVM in its price range.

Extra features include:

- Frequency characteristic to 300 megacycles
- Very accurate capacitance scale
- Perfectly matched high frequency probe

This fine instrument provides the sensitivity range and completeness of test necessary for today's fast and profitable radio-TV service. Also, meets the high requirements of the electronic or industrial laboratory engineer.

Write today for complete information or see your nearest HICKOK jobber.

THE HICKOK ELECTRICAL INSTRUMENT CO.
10524 Dupont Ave. • Cleveland 8, Ohio

Spot Radio News

★ Presenting latest information on the Radio Industry.

By RADIO & TELEVISION NEWS'
WASHINGTON EDITOR

THE POUNDING BATTLE FOR TV frequencies, delayed for over four years by the cease-allocation order of September '48, erupted with a fury during the late Fall months, as applicants buried the Commission's offices with demands to be heard on the channels they earnestly thought they should be awarded. And as this column was being prepared, the arguments were still loud and furious, and will probably grow in vigor and number during '53.

Competition for very-high bands in the far west set the stage as the hearings began, with four applicants asking for a pair of v.h.f. channels in Denver, and a dozen serving notice that they wanted three very-high rights plus the authority to operate a u.h.f. station, too.

Channel 7 was the tug-of-war victim during the initial sessions, with Aladdin Radio and Television, operators of KLZ and some theaters, and Denver Television, who also owns a chain of theaters, asking for the choice spot. The popular channel 4 was also in the contest ring, with KMYR Broadcasting and Bob Hope's associates seeking the rights; Hope and his colleagues became owners of KOA in the late summer, paying over \$2,500,000 for the Denver property.

An assortment of legal entanglements appeared as the contestants pleaded their case. Anti-trust suits, entered earlier, against and by the theater interests involving substantial damage claims, were hotly debated as issues which must be considered before channels are approved. While, it was noted, the individual suits cannot be afforded a trial during the hearings, it was said to be necessary to evaluate the factors involved and balance them against an ultimate decision. Supporting the interests of Denver TV was none other than the former assistant general counsel in charge of the broadcast division of the Law Department, Harry M. Plotkin, this time serving as a member of the law firm of Arnold, Fortas and Porter.

A revealing study of station costs emerged as the contestants were examined. In an exhibit, submitted by KLZ-TV, it was disclosed that the total cost for facilities alone would be close to \$600,000, and over \$600,000 would be spent for operation. Over a quarter of a million dollars will be used to meet the annual payroll for

around 60 persons. During the first year, it was admitted that a loss would be suffered, but the second year should provide a satisfactory profit. Testimony also disclosed that a substantial portion of the money required will be supplied by a bank loan plus loans from stockholders.

The south and midwest were embroiled in another brace of hearings; Tampa and St. Petersburg, Florida, contestants seeking channels 8 and 13, and Wichita, Kansas, applicants asking for channels 10 and 16. Two newspapers and some ad men served notice that they would like to have the channel 8 TV spot, while a newspaper, department store operator, and a group of business men sought channel 13. In support of its claim to channel 8, WFLA, owned by the *Tampa Tribune*, indicated that nearly a million dollars would be spent to build a station if they received the green light. A staff of 72 would be employed, and expenses were estimated as over a half-million dollars for the first year. The *Petersburg Times*, operators of WTSP, also asking for channel 8, declared that they would spend over a million dollars for construction of a new TV station, and over six hundred thousand dollars for operations, with a staff of 55.

Not only were law and finance headlined at the sessions, also covered were the technical qualities of personnel at the engineering helm, antenna sites and their relation to coverage and possible interference, and program preparation. It certainly appears as if an extremely sincere effort is being made to investigate every facet of potential management control and technical facilities before the rich channel awards are made, a task that will truly demand shrewd decisions.

AS THE FIGHT FOR CHANNELS roared on, the Commission continued to grant approvals for ultra-high and very-high frequencies. At this writing, the south and west were still holding on to their leadership in the race for initial awards. Texas was again particularly prominent on the grant calendar: KEPO in El Paso received channel 13 and will operate with an *erp* of 120 kilowatts; KGNC, Amarillo, won channel 4, and will use 100-kilowatts *erp*; KFDA, also in Amarillo, received approval for channel 10, and

RADIO & TELEVISION NEWS

HICKOK

True VTVM

FREQUENCY TO 300
MEGACYCLES



Model 209A

THE HICKOK ELECTRICAL INSTRUMENT CO.

10514 Dupont Avenue • Cleveland 8, Ohio

ACCURATELY MEASURES CAPACITANCE

1mmf to 1000 mf

- High frequency vacuum tube probe included
- Large 9" meter with zero-center scale
- RMS or Peak-to-Peak voltage measurements
- Resistance measurements as low as 1/10 ohm
- Laboratory accuracy
- Unexcelled dependability

WALSCO

UHF

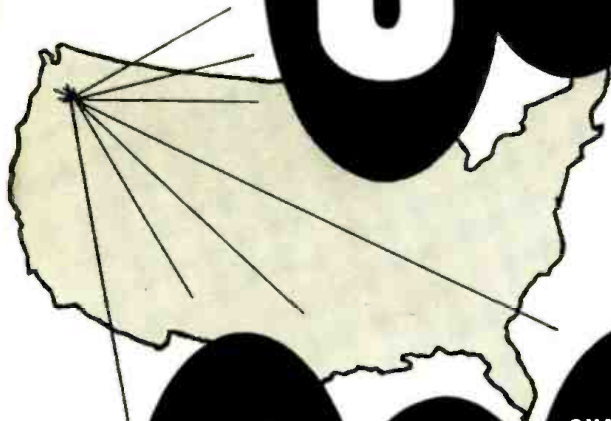

FIRST
antenna to be
tested and
accepted in
Portland

PROVEN
America's Finest
all-channel
UHF
antenna

GUARANTEED
everywhere,
anywhere
for one
full year

AVAILABLE NOW!

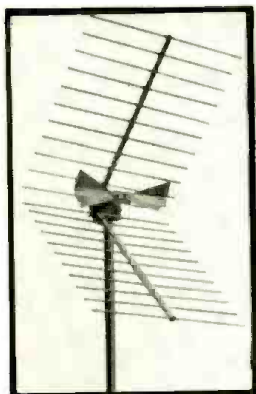

Corner Reflector Model 4450

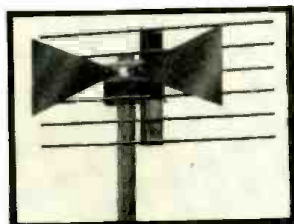

Reflecto-Fan Model 4400

Gain in db.*			
Freq.	Mod.	Mod.	Mod.
MC	4400	4402	4450
500	6.1	8.4	7.8
600	7.6	10.6	8.9
700	8.9	11.9	11.0
800	7.9	11.3	12.9
900	7.0	9.0	11.8

*Measured gain over tuned folded dipole
List Price

Model 4400 (Single Bay).....\$ 6.75
Model 4402 (Dual Stack)..... 14.25
Model 4450 (Single Bay)..... 14.50

WALSCO

Walter L. Schott Company
3225 Exposition Place
Los Angeles 18, California

Overseas Representative: Ad Auriema, Inc. 89 Broad St., New York 4, N. Y.

will have a 56-kilowatt output; KCBD, Lubbock, will be allowed to use channel 11 with a power of 92 kilowatts, while the Texas Telecasting Company, also located in this city, will use channel 13 with an *erp* of 31 kilowatts. Out in Sioux City, Iowa, the Great Plains Television Properties, received channel 36 and permission to operate with a 18.5-kilowatt output. In Pueblo, Colorado, KCSJ received channel 5 and authority to use a 12-kilowatt output. KFOR, Lincoln, Nebraska, received approval for channel 10, and will have an output of 56 kilowatts. WLBC, Muncie, Indiana, received authorization for channel 46 and a 16-kilowatt output. In Asheville, N. C., WISE will go on the air on channel 62 with an output of 23 kilowatts. St. Petersburg, Florida's WSUN, was told they would be able to use channel 38 with a power output of 83 kilowatts. KTTS, Springfield, Missouri, received a channel-10 award and will operate on 12.5 kilowatts. The eastern sector also appeared on the award schedule, with several interesting grants: WFPG, Atlantic City, received an okay for channel 46 and an *erp* of 18 kilowatts; WATR, Waterbury, received channel 55 and approval for an output of 245 kilowatts; and WEST, Easton, Pennsylvania, won channel 51 and a power of 2.25 kilowatts. The latter approval was won only after a bitter contest, which resulted in dissents from three Commissioners; Headman Paul Walker, Eugene H. Merrill, and Frieda Hennock. WKNB, New Britain, Connecticut, who had received one of the earliest approvals for channel 30, and then was told it could not proceed with construction until channel reallocations in six cities had been studied to correct for table deficiencies, finally received the go-ahead and is expected to proceed with construction immediately.

DOZENS OF CHANNEL WINNERS waxed quite optimistic on starting dates in their target schedules submitted to the Commission. Many assured Washington that they would be on the air before the year is out. Among those who were certain that they would begin telecasting soon were: WBRE-TV, Wilkes-Barre, Penna., (channel 28); WHUM-TV Reading, Penna. (channel 61); KTBC-TV, Austin, Tex. (channel 7); WROV-TV, Roanoke, Va. (channel 27); KDEN (TV), Denver (channel 20); WKAB-TV, Mobile, Ala. (channel 48); WJTV, Jackson, Miss. (channel 25); WSBT-TV, South Bend, Ind. (channel 34); WHYN-TV, Holyoke, Mass. (channel 55); WAKR-TV, Akron, Ohio. (channel 49); WKST-TV, New Castle, Penna. (channel 45); WILK-TV, Wilkes-Barre, Penna. (channel 34); WNOK-TV, Columbia, S. C. (channel 67); and WEEK-TV, Peoria, Ill. (channel 43).

THE ELECTION OF GENERAL EISENHOWER to the Presidency has
(Continued on page 133)

RADIO & TELEVISION NEWS

RADIO-ELECTRONIC *Engineering*

S E C T I O N

**RADIO &
TELEVISION
NEWS**

Reg. U.S. Pat. Off.

TELEVISION • RADAR • ELECTRONICS • RESEARCH • COMMUNICATIONS • MICROWAVES

JANUARY, 1953

RADIO TELEMETERING SYSTEMS
3

ELECTRONIC DEFIBRILLATOR
7

VERSATILE D.C. AMPLIFIER
8

THE NBS PRIMARY FREQUENCY
STANDARD
10

WIDE RANGE FREQUENCY CALIBRATOR
12

UNIVERSAL RECORDER-REPRODUCER
14

SENDING END IMPEDANCE OF
UNIFORM LINE
32

DEPARTMENTS

NEW TUBES	18
NEWS BRIEFS	20
LOOKING AT TUBES	22
NEW PRODUCTS	24
NEW LITERATURE	26
TECHNICAL BOOKS	27
PERSONALS	28
CALENDAR	31



Copyright, 1952, by Ziff-Davis Publishing Co.

RADIO-ELECTRONIC ENGINEERING is published each month as a special section in a limited number of copies of RADIO & TELEVISION NEWS, by the Ziff-Davis Publishing Company, 366 Madison Avenue, New York 17, N. Y.

Edited by H. S. RENNE
and the Radio & Television News Staff

Helical antenna for receiving telemetering information from guided missiles. This installation is at the Air Force Missile Test Center, Cape Canaveral.

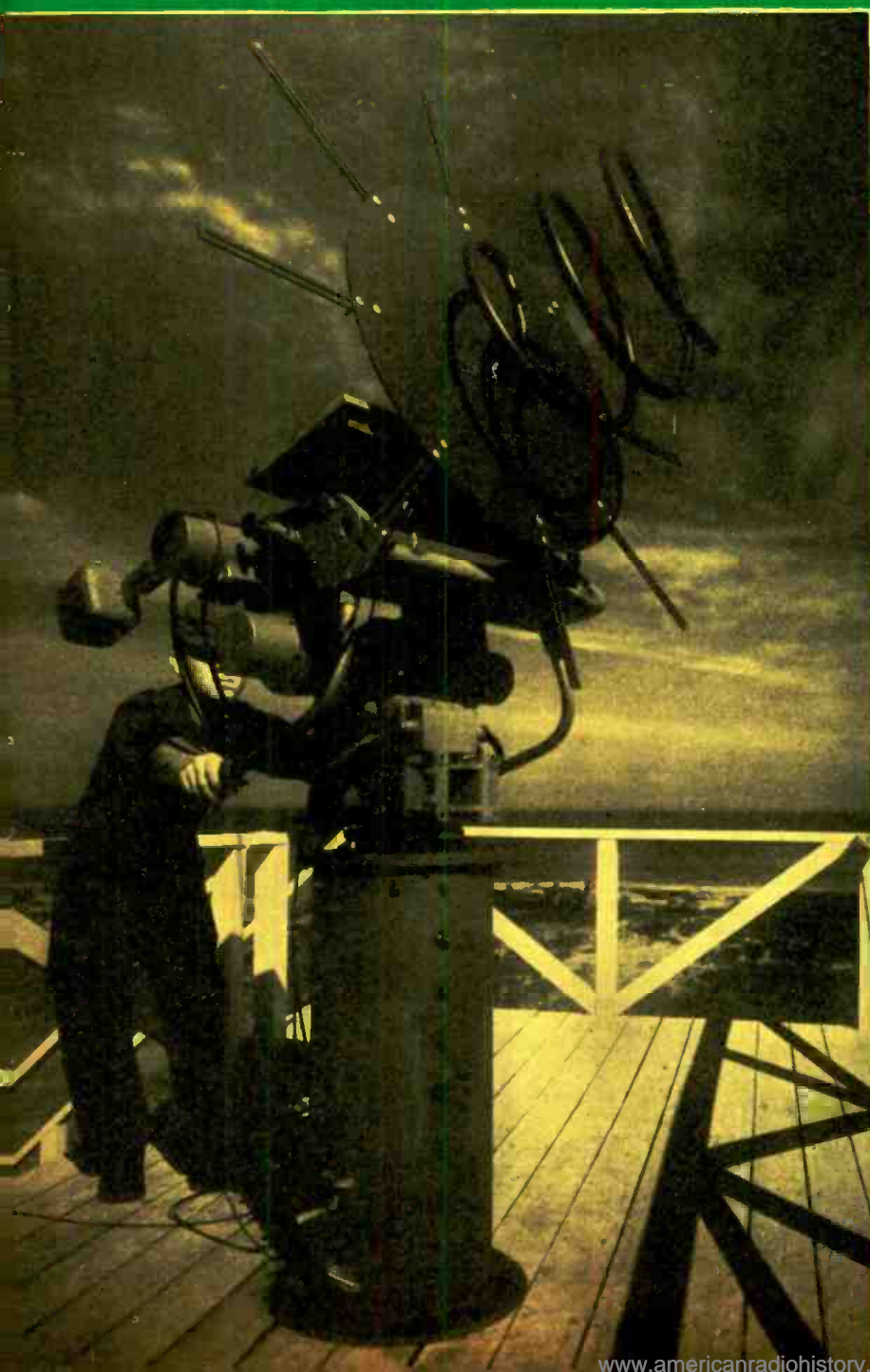

CUT MANUFACTURING COSTS

With high quality Sylvania Tungsten and Chemical Products



Section of the metallurgical laboratory of our engineering department.

General view of Sylvania tungsten wire drawing department at our Towanda, Pa. plant.

You take no chances—save time and money—when you use Sylvania tungsten and chemical products. Sylvania tungsten is quality controlled from ore to finished product, tested in the laboratory, in the field. Suppliers to all leading manufacturers in the radio and television industry, Sylvania offers you tungsten and chemical products that meet the highest standards of purity, precision, and uniformity.

To help you work out any special high quality product or solve your toughest manufacturing problems, Sylvania maintains large metallurgical and chemical laboratories. If it's a question of anything from a precision, custom-made tungsten component, a special high-purity phosphor, chemical or compound, to silicon or germanium for crystals, put it up to Sylvania. A note on your letterhead brings you full particulars. Address: Sylvania Electric Products Inc., Dept 3T-3501, 1740 Broadway, New York 19, N. Y.

SYLVANIA

Tungsten

- Radio Heater and Grid Wire
- Support Wire and Rod
- Gold Plated Wire
- Ground Seal Rod
- Formed or Ground Parts
- Cut and Bevelled Pieces
- Hand Wound Coils

Special High Purity Chemicals and Compounds

- Potassium Silicate • Etching Inks
- Carbonate Emission Coatings
- Mica Spray Coatings
- Basing Cements

Metal Powders

- Silicon • Germanium

Phosphors

- Cathode Ray Tube Phosphors

TUNGSTEN & CHEMICAL PRODUCTS; RADIO TUBES; TELEVISION PICTURE TUBES; ELECTRONIC PRODUCTS; ELECTRONIC TEST EQUIPMENT; FLUORESCENT TUBES, FIXTURES, LIGHT BULBS; PHOTOLAMPS; TELEVISION SETS

RADIO TELEMETERING SYSTEMS

By **DAVID FIDELMAN**

MODERN industrial and engineering techniques often require transmission of measurement data to some remote point at which central control and analysis functions must be performed. Telemetry of data from remote points is often important in applications where large distances are involved, as in the transmission of power, in railroading, and in aircraft and guided missile research. Some applications require the transmission of a relatively small amount of information over wires which are already in existence, and present no really serious problems. However, a great many important applications require the transmission of a large amount of data over radio links, necessitating very efficient use of the radio-frequency band. Such applications are encountered in much of the present aircraft and guided missile research program, in meteorological exploration, and wherever else it is impossible or impractical to connect wires for transmission of data.

The electronic installations that perform this telemetry function use equipment of considerable complexity, and must be compact, rugged and reliable, since in most cases weight and size are important factors, and often the data can be obtained only once. A number of different methods can be used to obtain the data at the remote point, to transmit it to the central receiving station, and to analyze and record it for control and further analysis at a later time. The specific setup and operation of the telemetry system depend primarily upon the requirements of the individual application. Factors that are important in determining the characteristics of the system are: the type of data which is to be transmitted; the rate at which the measured quantities vary in time; the required noise level and accuracy of measurement and transmission of the measurement data; and the number of variables which are to be transmitted.

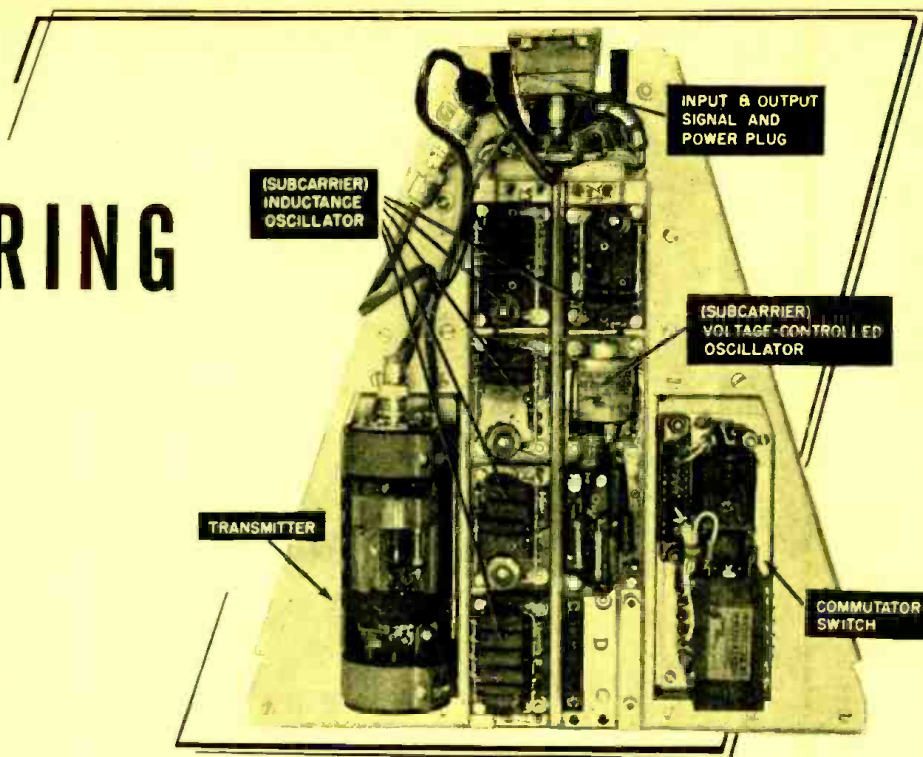

Guided missile FM-FM telemetry assembly which includes a voltage-controlled subcarrier oscillator, a number of variable-inductance oscillators, a commutator switch (for further multiplexing on any one subcarrier), and the FM transmitter.

Equipment and techniques used in telemetry data over long distances, as in guided missile research.

Because of the wide variety of problems that require the telemetry of data, a number of different systems have been developed to meet the needs of the various applications. For example, some applications call for the transmission of data at extremely high speed with very good high-frequency response, others might require transmitting the result of a single measurement for a long period of time with moderate frequency response, while a great many applications demand the transmission of several different sets of data simultaneously to maintain the exact time relationship between them. The design of the different telemetry systems will, of course, be quite different, depending upon the type of data for which they are to be used. This article will illustrate some of the design principles of radio telemetry systems by describing the essential elements of systems for the transmission of a number of simultaneous sets of data on a single radio channel. The transmission of single-channel information also has many important applications, but since the multichannel systems may have all the features of single-channel systems and be at the same time much more versatile and general in their application, the multichannel systems will be emphasized.

Any radio telemetry system con-

tains the basic component units shown in the block diagram of Fig. 3. It consists essentially of a number of transducers for converting each of the metered quantities into electrical signals, a device for combining the several electrical signals into a single composite signal, and a radio transmitter whose carrier is modulated in some manner by this composite signal. The signal from the transmitter is picked up by the receiver at the central receiving station and demodulated to give the original composite signal. This composite signal is then separated into the individual signals which, after being detected, operate an indicator to record the values of the metered quantities by means of a recorder.

The data are generally measured by some form of electromechanical transducer which changes mechanical and certain electrical quantities into corresponding electrical currents or voltages. Some of the basic physical parameters which may be measured are:

- Displacement or position
- Velocity
- Acceleration
- Temperature
- Pressure
- Flow
- Force
- Weight
- Light or emissivity



A 7-track portable data recorder.

The development of several different types of compact and flexible transducers for measuring these quantities and converting them into corresponding electrical signals simplifies the design and setup of the complete system, and makes it possible to engineer telemetering systems on a unitized basis using standard units instead of having to design a completely new system for each different application.

Transducers may, in general, be designed so that the value of the measured quantity can be represented as a value of voltage or current, or as a variation in the value of a reactance. The specific type of transducer to be used in any specific application depends primarily upon the manner in which

Fig. 1. Typical pulse trains showing composite signal for different types of time-division multiplex systems.

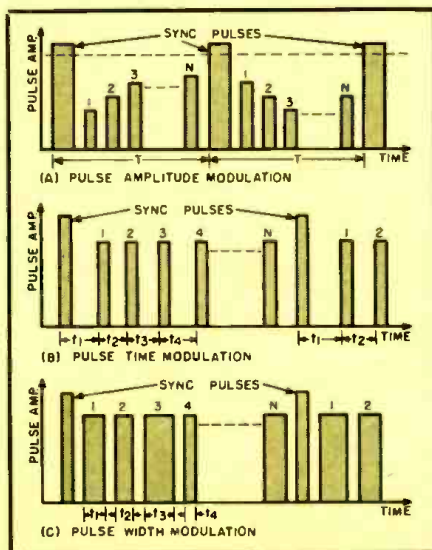

the various signals are combined, and upon the type of modulation which is to be used in the transmitter. When the type of modulation and the circuit operation require a voltage or current to be proportional to the magnitude of the measured quantity, thermocouples, variable resistance elements, and various forms of electromechanical servos are useful types of transducers. When frequency-modulated subcarrier systems are used, variable-reactance types of transducers are most convenient because they can directly modulate the frequency of an oscillator.

There are a number of possible methods for transmitting several simultaneous measurement channels on the same carrier. These methods may be divided into two general classifications:

1. *Time-division methods*, in which the various signals are transmitted on a single carrier by sampling the various signals in succession, using a sampling or switching device
2. *Frequency-division methods*, in which the various signals are transmitted on a single carrier by modulation of a number of different subcarriers in a multiplex system

Each of these methods may be employed in a number of different ways, depending largely upon the requirements of the specific applications and the manner in which the original data are derived. Considerable work and effort have gone into developing and perfecting systems of telemetering by each of these methods.

The specific types of time-division and frequency-division radio transmission systems may best be classified according to the method of modulation that is used:

Time-Division Systems

PAM-AM—pulse amplitude modulation

on an amplitude-modulated carrier

PAM-FM—pulse amplitude modulation on a frequency-modulated carrier

PWM-FM—pulse width modulation on a frequency-modulated carrier

PPM-AM—pulse position modulation on an amplitude-modulated carrier

PCM-AM—pulse code modulation on an amplitude modulated carrier

Frequency-Division Systems

AM-AM—amplitude-modulated subcarrier on an amplitude-modulated carrier

FM-AM—frequency-modulated subcarrier on an amplitude-modulated carrier

AM-FM—amplitude-modulated subcarrier on a frequency-modulated carrier

FM-FM—frequency-modulated subcarrier on a frequency-modulated carrier

Although other variations and combinations are possible, these methods represent the majority of those in general use at the present time.

Since the method of modulation and the transmission system determine the signal-to-noise ratio, the maximum range obtainable with a fixed amount of power, and the amount of information that can be transmitted in a given amount of time, certain of the modulation methods give better results than others. In general, PAM-FM, PWM-FM and PPM-AM are the best time-division methods, while FM-FM is the most widely used frequency-division system.

In the basic time-division method of transmitting information, signals in the various channels are sampled in sequence by means of some sampling or switching device. This may be done by either a mechanical or an electronic switch. The signal to be recorded will, therefore, consist of a series of pulses, each of which represents the magnitude of a single channel at that particular instant of time.

When time-division telemetering is used for the transmission of information, the various inputs as shown in the block diagram of Fig. 3 are applied to the inputs of a commutator sampling device. This commutator may be either a mechanical or an electronic channel switch. The output signal from the commutator consists of a series of pulses of one of the types shown in Fig. 1. In *pulse amplitude modulation* systems, the various pulses have essentially constant width and position but vary in amplitude; in *pulse time modulation* systems, all the pulses have constant amplitude (except for the synchronizing or reference pulse), but their relative time position varies; in *pulse width modulation* systems, the amplitude and relative time position of the pulses remain constant with the pulse duration varying. *Pulse code mod-*

ulation is essentially a specialized form of pulse amplitude modulation (or of any of the other systems) in which the data signal is converted into a sequential group of pulses representing a binary code.

The resulting series of pulses from the output of the commutator is a single-channel signal which modulates the r.f. carrier and is transmitted on a single radio channel to the receiver. When the signal is received and demodulated, it consists of the same series of pulses as shown in Fig. 1. This series of pulses must then be separated into the correct channels. The decommutator for performing this function is usually an electronic switching circuit which can be properly synchronized, since a mechanical switch would have too much inertia for correct synchronization. After the pulses have been demodulated, the information they contain is in the form of pulses as shown in Fig. 5. These pulses must be integrated in order to deliver the original signal again as a continuous waveform. By the sampling theorem, if the time interval between pulses is T , then the highest frequency component which can be reproduced is $1/2T$ cycles per second (although a higher number of samples is, of course, preferable for high accuracy systems). This limitation determines the requirements of the commutator switching system and of the transmission system.

Mechanical switches are commercially available which are capable of as many as 60 contacts at rates up to 60 rps—i.e., 3600 contacts per second—and experimental switches have been able to sample as many as 12,000 contacts per second. Thus, assuming 3600 contacts per second with each alternate contact left blank to give break-before-make isolation between adjacent channels, and connecting the contacts in groups to give maximum frequency response in each channel, a ten-channel system would then be sampled every 1/180-second per channel while a five-channel system would be sampled every 1/360-second per channel. This would permit a frequency response up to 90 cps for the ten-channel system and up to 180 cps for the five-channel system. When the required frequency range falls within the limits obtainable with such switches, it is often simplest and most convenient to use mechanical commutation inasmuch as these switches are compact, reliable, quite versatile because of the many wiring combinations possible, and result in simpler circuits than electronic switching methods. A photograph of a standard commercial sampling switch designed to sample 60 contacts at rates up to 60 rps is shown in Fig. 2.

When better high frequency response

is required, and for systems where this type of switching is not applicable, electronic switching systems must be used. Practical electronic commutator circuits have been developed which can provide 16 data channels with 6400 information samples per second in each channel. In electronic commutators for pulse amplitude modulation, the input voltage is applied to the grid of an amplifier tube which is gated to conduct at the proper time by means of a proper synchronizing pulse generator. In pulse width and pulse time modulation systems, the input voltage signal controls the time of firing of a multivibrator, a thyatron, or of some similar circuit whose timing can be made to depend upon input voltage.

The frequency-division system makes use of a number of subcarrier oscillators of different frequencies which are modulated by the signals to be transmitted, and the modulated subcarriers are then combined into one composite signal which can be transmitted on a single carrier. Modulation may be either AM or FM, depending upon the requirements of the system.

The basic block diagram for a frequency-division multiplex system is shown in Fig. 4. Each of the various input signals is applied to the modulation input terminal of a subcarrier oscillator. When amplitude modulation of the subcarriers is to be used, the measured signal should produce a proportional voltage which can be amplified, if necessary, and then used to amplitude-modulate the oscillator. If frequency modulation of the subcarriers is used, the output of the measuring transducer may be a variable voltage which can be connected to control the frequency of a multivibrator, or a variable-reactance transducer may be used as one element in a tuned circuit to control the frequency of a tuned oscillator. The modulated subcarriers are then combined in a mixing circuit which may, in the simplest case, consist of a number of resistors properly connected to add the various signals together and give proper isolation between the different channels.

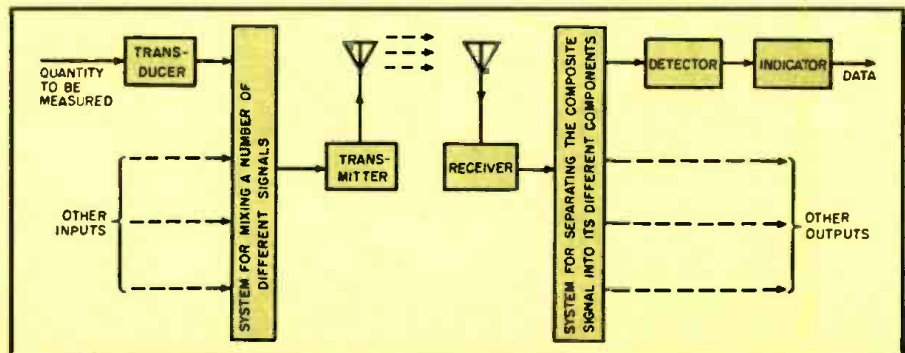

Fig. 2. The ASCOP Model 1-30-30S multichannel mechanical commutator.

Choice of the type of modulation and the design of the transmitter must represent a compromise between the required accuracy and frequency response of transmission, and the complexity, size and weight of the equipment involved. The methods of modulation are generally those which give highest accuracy and lowest noise level. As mentioned before, the PAM-FM, PWM-FM and PPM-AM are the best time-division methods, while the FM-FM is the most widely used frequency-division system. Superiority of one system over another is shown by the theoretical analyses of communication theory, taking into consideration the factors of transmitter power, range, signal-to-noise ratio, and interchannel cross-modulation.

The multiplexed signal, whether it is based upon the time-division or the frequency-division method, is then used to amplitude-modulate or frequency-modulate the carrier according to the transmission system which is being used. Nominal output power of the basic airborne telemetering transmitters generally ranges from 0.5 to 4.5 watts. Power amplifiers with outputs from 15 to 50 watts may be used with the transmitters where space and weight requirements permit, and where the transmission range is long enough to justify the increased size and weight. It has been found that a 3-watt transmitter will generally give a reliable range of from 60 to 120 miles under

Fig. 3. Block diagram of the basic telemetering system.



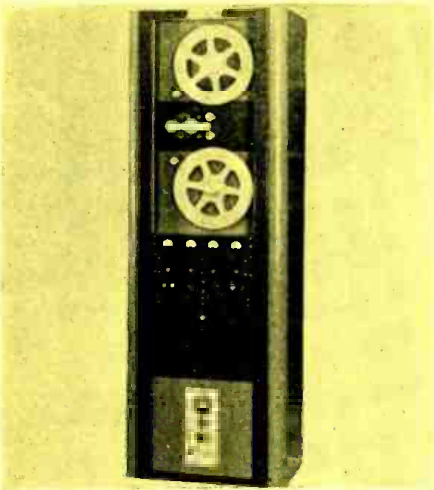

This Fairchild magnetic tape data recording system may be used to record telemetered data of various kinds.

line-of-sight conditions if a receiving antenna of reasonable gain is used at the receiving station.

Antennas used in airborne telemetering systems represent a problem. The ideal transmitting antenna should have a spherical radiation pattern such that a uniform signal will be radiated regardless of the altitude of the transmitter, and at the same time it should not change the external surfaces of any aircraft on which it may be mounted. Radiation is often obtained by actually exciting the aircraft itself so that it acts as the radiator, by shunt exciting a control or lifting surface, or by means of faired-in slot antennas or electromagnetic wave directors such as polystyrene rods.

The requirements of the receiving station are generally much less difficult than those of the transmitter. Basically, the station consists of:

1. An antenna, high-gain and directional so that it can track the transmitter
2. A receiver suitable for detecting the type of modulation used in the transmitter
3. A decommutator or set of filters to

Fig. 4. Block diagram of basic system for frequency division multiplexing.

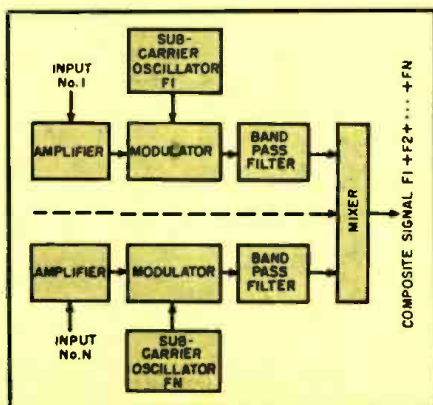

separate the composite signal into the individual channels

4. A recorder with which to record the composite signal permanently for further study
5. A set of detectors and indicators for each channel to indicate the measured quantities as their values are being transmitted

Other components may also be included, according to the special needs of the particular application. The observing station may frequently be the control location for a missile or aircraft under observation and would therefore require special equipment for maintaining contact with the aircraft. Such equipment might consist of special aircraft instruments indicating the telemetered data for control observation by the control operator.

Antennas and receivers used at the ground stations make use of standard techniques, with the emphasis on high gain and low noise. The antennas are usually highly directive, and preferably should be circularly polarized to minimize polarization effects. Generally, 7 to 10 db gain can be obtained in the antenna with satisfactory beam width. In many installations, radio or radar tracking devices are used to follow a flight; such equipment may be used to control the antenna system so that it will be always directed toward the vehicle in flight.

A helical antenna for use in guided missile telemetering systems is shown in the cover photograph (page 1). The mounting is designed to facilitate tracking of the missile. This particular installation appears at the Air Force Missile Test Center at Cape Canaveral.

Receivers used at the observing station should have the highest possible performance, and noise should be held to a very low level. Usually, the sensitivities of telemetering receivers closely approach the theoretical. For FM receiving systems, the sensitivities are of the order of 2.7 microvolts for 20-db quieting, with noise held to 6 db or less.

The output from the receiver will be the composite multiplex signal which must then be separated into the individual channels. The system to be used for this purpose depends upon the particular type of multiplexing that is used in the transmitter. If time-division multiplexing is used, a synchronized decommutator decodes the composite pulse signal. The various channels must be gated at the proper time, and a suitable detector provided for the particular type of pulse modulation. The pulse signal in each channel is then passed through a low-pass filter which cuts off just below the sampling frequency to restore the original signal.

Output signals from each channel may then be processed or observed in

any desired manner. They may be presented on instruments for control purposes, indicated directly on paper-tape oscillograph records for study, or recorded for further study at a later time. When the signal is to be recorded for later study, the simplest and most satisfactory method is to record the composite signal from the receiver by means of a magnetic tape recorder. This method has the following advantages: a large amount of information can readily be stored on a relatively small volume of tape, it can be played back indefinitely without loss of information, and the exact time relationship of the various signals may be maintained. The composite signal may also be demultiplexed and recorded on a single magnetic tape by use of multi-track recorders, which have the same advantages and do not require further decoding of the multiplex signal.

Commercial tape recorders are available at present that have been designed specifically for the recording of telemetering information. These instruments have been designed for extremely stable motions and wide frequency response. Units are available which have as low as 0.1% peak-to-peak flutter and can be used for recording either the composite signal, several different channels simultaneously, or a combination of both. Multiple tracks can be recorded with frequency response of ± 3 db from 200 to 80,000 cps and signal-to-noise ratios of 40 db below 1% harmonic distortion for 16-minute or 32-minute recording time. More recently developed tape recorders are capable of recording as many as 14 separate channels with a frequency response in each channel of 0 to 5000 cps or 0 to 10,000 cps, depending upon the tape speed. Other information on data recording systems appeared in an article by Robert Endall entitled "Magnetic Tape Data-Recording Systems," in the March, 1952, issue of RADIO-ELECTRONIC ENGINEERING.

Use of these magnetic tape recording techniques greatly increases the flexibility of telemetering installations, for they make it possible to record the received information under conditions where it would be difficult to receive and process data immediately.

Fig. 5. Signal in each channel after decommutation and demodulation in any time-division multiplex system, showing integration of pulse amplitudes to give the original signal.

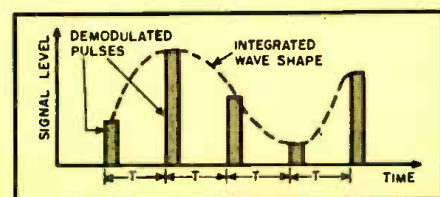

ELECTRONIC DEFIBRILLATOR

By
R. M. SHEPARD, M.D.
 and
H. J. WHITEHILL JR.
 Coleman Instrument & Mfg. Co.*

CARDIAC arrest is an acute emergency which may occur at any time in the operating room, and during any type of surgical procedure. It seems more prone to occur in cases where there has been a difficult induction of anaesthesia with cyanosis, respiratory obstruction or hypotension. Both the anaesthetist and the surgeon must constantly observe the pulse and the color of the blood so that cardiac arrest may be discovered as soon as it has occurred. The heart beat must be restored within three minutes of its cessation if it is to be successfully restored at all.

In such an emergency, the chest should immediately be opened and the pericardial sac incised. Usually the heart will be found to be still and large, having stopped in diastole. While the anaesthetist inflates the lungs, the surgeon squeezes the heart 60 to 100 times a minute. Appropriate drugs such as procaine, pronestyl, adrenalin and calcium chloride are given. Massage is continued until the heart has picked up a vigorous beat on its own.

Occasionally when the pericardium has been opened, the heart will not be found in arrest but undergoing a vigorous squirming movement. This condition is known as ventricular fibrillation, and there is no dependable way of arresting it except by the use of electric shock. In fibrillation, the writhing motions of the heart do not propel any blood, and since no medication will restore a normal beat, a defibrillator must be used if the patient is to be saved. By means of the defibrillator, a strong electric current is passed through the heart which causes all of its muscle fibers simultaneously to contract, and then relax. From this relaxed state a normal beat may be restored.

After a diagnosis of ventricular fibrillation has been made, the defibrillator electrodes are placed on each side of the heart, and a series of three shocks, lasting from 1/10 to 2/10 of a

The instrument in its case, with the electrodes shown in front of the enclosure.



An instrument for applying a carefully controlled electric shock to the heart to halt fibrillation.

second each, are passed through the cardiac musculature. This will usually throw the heart into a period of arrest from which massage can restore a normal beat. If the heart continues to fibrillate, an additional series of shocks must be initiated until the fibrillation is stopped.

The Coleman Defibrillator

At the request of R. M. Shepard, M.D., of Tulsa, Oklahoma, Coleman Instrument and Manufacturing Company in July, 1952, proceeded to design a new and improved defibrillator for general use in hospital operating rooms—an instrument which would minimize risk to both the patient and the operating surgeon.

Design

This defibrillator, known as Model 173, is designed to deliver a 60-cycle output, adjustable between 0.5 and 2.5 amperes. The output is in the form of a pulse of adjustable length, automatically timed within the instrument; the pulse length interval is adjustable between 0.03 seconds and 0.50 seconds by means of a calibrated control on the panel.

The pulse network is designed so as to render impossible overtreatment of the patient through a personal error of

the operator, and so that in the event of failure of any of its parts, such failure would be harmless to both the surgeon and the patient. The output of the defibrillator has no detectable electrical potential with respect to earth ground, i.e., it is impossible for the surgeon to receive a shock while simultaneously touching an electrode and a grounded object during treatment. All electrodes employed are easily sterilized and so designed as to minimize shock hazard to the user.

A test circuit is incorporated in the instrument to show that everything is in order before its application to a patient. Testing insures that the proper current intensity will be delivered to the patient's heart and also checks electrical continuity at the electrodes. These two tests are made automatically by pressing a "test" button. Under no circumstances do these tests strike an arc at the electrodes, as such an arc could conceivably touch off a disastrous explosion in a cyclopropane atmosphere.

Operation of the instrument is simple in the extreme; a previously unpracticed operator can successfully carry through a treatment.

Description

The current output to the electrodes
(Continued on page 30)

*716 S. Troost St., Tulsa 10, Oklahoma.

VERSATILE D.C. AMPLIFIER

By
J. S. DERESKA

Development Engr., Strong Cobb & Co.

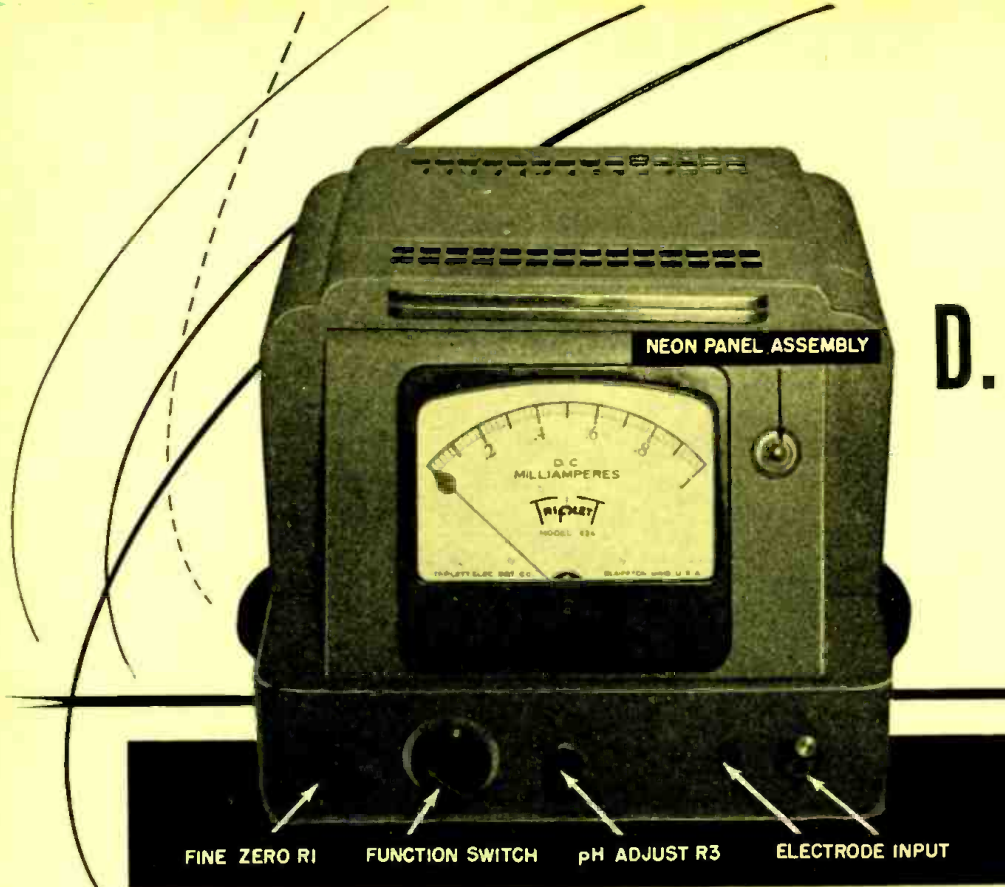

Front view of the instrument, showing location of the controls.

Design and operation of two-stage d.c. amplifier for instrumentation purposes, such as pH indications.

DURING the course of analytical work in a shop or laboratory, the occasion often arises for measuring d.c. voltages and currents from high impedance sources. Using v.o.m.'s and standard v.t.v.m.'s for such measurements is an expensive proposition and these units, moreover, sometimes prove to be inadequate. The factor of expense particularly applies to the special commercial electronic instruments which could be used in these instances.

The problem of conveniently checking industrial temperature recorders and other instruments requiring a potentiometer for normal calibration was solved by the author through the construction of a straightforward, simple, two-stage, d.c. amplifier. This amplifier was adapted as a pH meter and has functioned as such for over two years with excellent results.

Designed to measure small currents and moderately low voltages from high impedance sources, the amplifier is well suited to electrometer tube applications. It may also be used as a fractional microammeter, a millivoltmeter, megohmmeter, pH meter, electronic polarized relay, recorder calibrator, voltmeter, and ammeter. Special features that were incorporated in the unit are: good linearity, good stability, two stages of push-pull amplification, simplicity, line operation, and the utiliza-

tion of standard radio components throughout.

Tube selection was very important in the design of this amplifier since its application in pH measurements requires input tubes with very low grid current consumption for stable operation. From a survey of about 12 tubes, the 12BE6 and the 6C8G were among those readily available receiving tubes which had desirable characteristics as input tubes. According to tests made by the author, the 12BE6 has very low grid current consumption, only slightly higher than that of special electrometer tubes if used at a plate voltage of 12 volts, a screen voltage of approximately 7.5 volts, with control grid negatively biased to -2.5 volts, and with d.c. heater current reduced to 105 ma. from 150. The grid current under these conditions is about 10^{-13} amperes. The disadvantages of using the 12BE6 were that a special transformer of about 9 volts a.c. would be required, that d.c. filament operation would be essential for this degree of efficiency, and that two 12BE6's would be required for a single stage of push-pull amplification. Thus, simplicity would be sacrificed for the sake of efficiency.

On the other hand, the 6C8G has almost as low grid current with slightly reduced filament voltages and is less

susceptible to line voltage fluctuations when a.c. heater-operated than the previously mentioned tube. This tube is a twin triode and hence suited to matched push-pull operation. Furthermore, it is larger and is capable of more efficient heat dissipation than the smaller tube. Also, the input grid is on top of the tube and affords better isolation than the miniature 12BE6.

After the selection of the 6C8G as the input tube, choice of a second-stage tube was made between the 6SN7 and the 7N7. Both are medium- μ twin triodes, but the 7N7 has two sections with more identical characteristics than those of the 6SN7, whose triode sections—it was found through testing—have different mutual conductances. However, sufficient adjustment range has been incorporated in the circuit of this amplifier to use the 6SN7. A 12AU7 can replace the 6SN7 if the plate circuit resistors for the input and output tubes are increased in value by about 5%.

There was considerable choice in the selection of the full-wave rectifier: types 6X5, 6X4, 6AX5, 6Z5, 84/6Z4, or even a full-wave selenium rectifier of at least 20-ma. capacity would be satisfactory. A 6H6 or 6AL5 could serve for light duty since the rectifier current does not exceed 10 ma.

Construction

On referring to the circuit diagram, it will be noticed that the circuit is straightforward; two stages of d.c. amplification boost currents of the order of fractional microamperes encountered in glass electrode measurements to over a milliampere. The circuit as shown is usable as a pH meter or millivoltmeter in the 0—250 mv. range. Use of smaller meters with less internal resistance than the one indicated will increase the sensitivity of the millivoltmeter so that the range is 0—100 mv. With more sensitive meters, greater instrument sensitivity is obtained. The range is

extendable by the use of appropriate input divider resistances.

It is important in construction to keep input leads as short as possible. The insulation resistance of the switch circuit involving the grid lead of the 6C8G must be the highest possible to avoid leakage losses and instability when measuring potentials from high impedance sources.

This instrument was housed in a marine gray ripple, ICA "super" streamlined sloping front amplifier chassis, 10" x 12" x 3". An extra large milliammeter was used to facilitate easy reading at relatively large distances from the instrument.

Placement of parts is not too critical; however, in accordance with accepted wiring procedures, the power transformer and rectifier were located at the rear of the chassis to minimize temperature effects. The amplifier tubes were placed relatively close together in order to keep the leads short. A 10K "coarse zero" control was placed to one side of the 6C8G and is adjustable from the top of the chassis by means of a screwdriver.

The "fine zero" control R_1 , with a knob at the left of the switch on the front panel, is available for convenient zero adjustment before a reading is taken. Some drift is inevitable and this is balanced out to obtain an initial zero reference for the amplifier. To the right of the switch on the front panel is the pH "adjust" control. This is used to calibrate the meter with buffer solutions for pH measurements, and to "zero in" the reference source.

The neon bias voltage regulator mounted on the front panel to the right of the meter serves as a pilot light; the series resistor must be removed from the panel light assembly. A standard glass electrode terminal plug adapter was made in the shop, but a similar one can be purchased from *Beckman Instruments, Inc.*, National Technical Laboratories, Pasadena, California. Special care was exercised in soldering to insure good low resistance connections.

Calibration

After wiring has been completed and checked, the tubes are inserted in their proper sockets. The 6C8G is pretreated before installation; it is carefully washed in absolute alcohol and dried very carefully with a clean, dry cloth. Then a thin solution of polystyrene dope is applied to the top of the tube, just below the grid cap. The tube is rotated with the fingers at the base of the tube in such a way that the polystyrene flows around in an even film to at least one-half the length of the tube. After drying, the tube is inserted in its socket, being handled

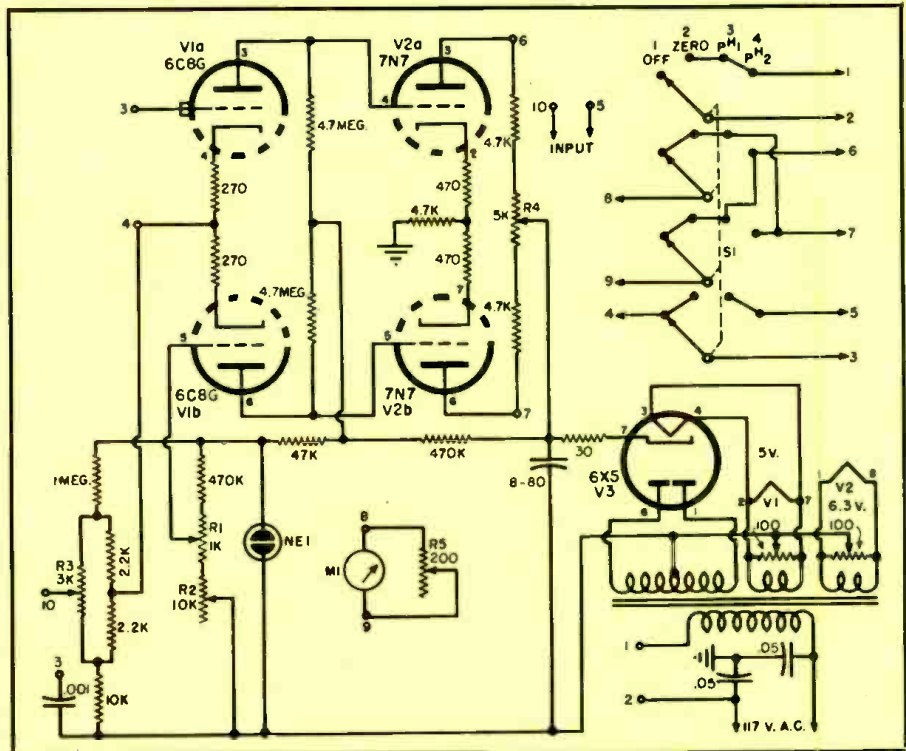

Circuit diagram and parts values for the d.c. amplifier.

with a paper napkin in order to avoid touching the tube with the fingers. The grid cap is pushed onto the tube cap with a napkin or pliers so that it fits tightly.

With the switch in the "off" or position 1, the line cord is plugged into a 115-volt a.c. power source, and all the potentiometers are adjusted to approximately their mid positions. Then the switch is turned one position clockwise from the normal "off" position. This second position is the "zero adjust" position. As the instrument warms

up, the needle will swing over the scale and settle back close to zero. If it does not do this, the "coarse zero" can be adjusted with a screwdriver until the meter reads zero. This should be done with the "fine zero" control at mid position to allow external range control of any drift encountered. Next, the grid input lead to the pin jack should be shorted and the switch turned clockwise to position 3 or "pH adjust" on the positive polarity reading scale. The plate balance potentiometer R_4 should
(Continued on page 28)

Rear view of amplifier showing location of components.

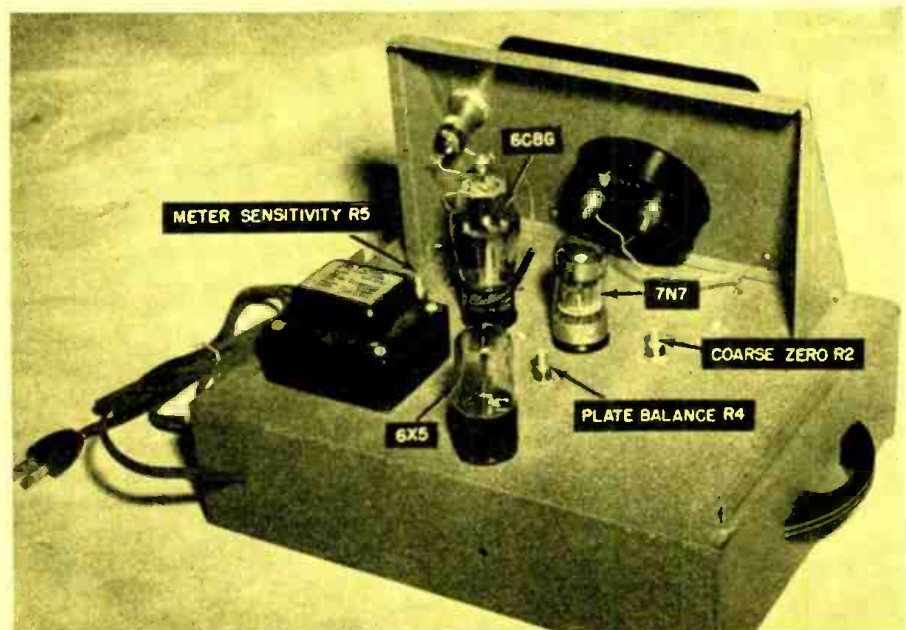



Temperature control compartment containing crystal and temperature-sensitive components for one of the nine oscillators.

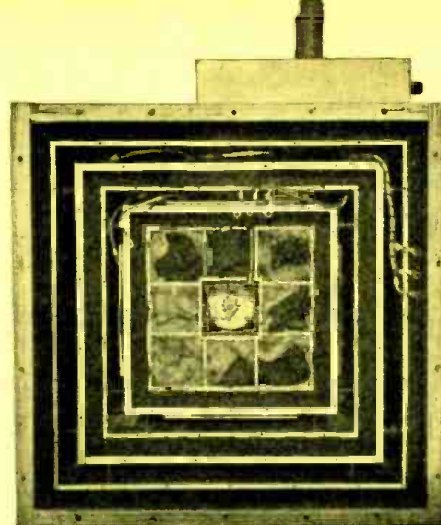

Temperature control compartment containing the resonator crystals of the primary standard of frequency. Crystals are in the center chamber.

THE NBS PRIMARY FREQUENCY STANDARD

Continuing investigation has improved the constancy and reliability of the NBS primary frequency standard.

By
JOHN H. SHOAF

Central Radio Propagation Lab.
National Bureau of Standards

ACCOMPANYING the maintenance of the nation's primary standard of frequency is a continuing investigation by the National Bureau of Standards of methods for improving the constancy and reliability of the standard. Some modifications incorporated within the last few years include the use of resonator crystals to sustain the accuracy of the standard, more sensitive and reliable temperature controls, and precise clock mechanisms to monitor time signals. The use of new and improved components has resulted in a reduction in the number of replacement parts, and represents a considerable saving of time normally required for preventive maintenance procedures.

The NBS primary standard of frequency is the foundation upon which all time and frequency transmissions from the Bureau's radio broadcasting stations WWV in Beltsville, Maryland, and WWVH, Maui, Territory of Hawaii, are based. From these stations, standard radio frequencies of 2.5, 5, 10, 15, 20, and 25 mc. are transmitted continuously, night and day, with accuracies of 2 parts in 100 million. Two standard audio frequencies, 600 and 440 cycles

(the standard musical pitch A above middle C) are broadcast on all of the radio carrier frequencies, and every five minutes they are interrupted for intervals of one minute. A pulse of 0.005-second duration occurs on each carrier frequency at intervals of one second. The time intervals, as transmitted, are accurate within \pm (2 parts in $10^8 + 1$ microsecond). An announcement of radio propagation conditions, pertinent only to transmission paths in the North Atlantic area, is broadcast in code on each of the standard radio frequencies.

The NBS standard consists of nine crystal-controlled oscillators and eight quartz crystal resonators. Three of the oscillators are located at the Beltsville

installation of WWV—one acting as the main oscillator for all of the transmitters, the second as a standby, and the third as a spare. The remaining six oscillators and the eight quartz crystal resonators are maintained in the Bureau's Washington laboratories. All of the crystal-controlled oscillators are kept in continuous operation and the best ones—those having the least amount of deviation from 100 kc. for the immediately preceding six-month period or longer—are the units from which the standard frequency is determined.

Oscillators are controlled by specially made GT-cut quartz crystals; the resonant frequency of each crystal is 100 kc. In examining the crystals, it has been observed that generally their performance curves (frequency vs. amplitude) have a flat region within which the crystal frequency is relatively constant. When the driving current reaches a value of about 150 microamperes, the frequency decreases sharply. In view of this fact, the driving current applied to the crystal units of the newer NBS oscillators is less than 100 microamperes. A decided improvement in performance occurs and is especially evident when compared to the older oscillators with driving currents of over 500 microamperes. In-

Block diagram showing basic components of the NBS primary standard of frequency.

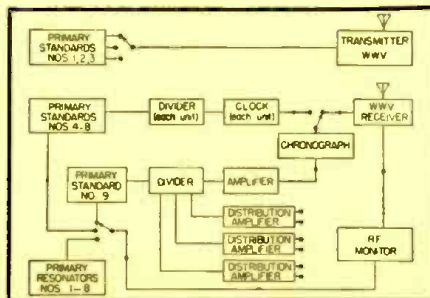

creased short-time stability and overall reliability have also been achieved.

The eight resonator crystals have been part of the frequency standard for about one and a half years. Each resonator's frequency is used in the analysis of the accuracy and constancy of the other nine oscillators. All eight crystals, each also with a resonant frequency of 100 kc., are installed in a single temperature-controlled oven. They do not incorporate additional components such as tubes, resistors or capacitors. They are not driven continuously but are used only once a day as part of a balanced-bridge network for comparison with one of the standard oscillators. Furthermore, the current driving the crystals is only 10 micro-amperes.

Once a day, the value of each resonator crystal and each standard oscillator is determined. First, a precision variable oscillator is adjusted to the frequency of one of the resonators. The variable oscillator is then compared to one of the standard oscillators, and the beat or difference frequency is counted on an electronic frequency counter with a precision of the order of parts in 10^{10} . The variable oscillator is readjusted to the second resonator crystal and again compared to the same standard oscillator. The difference frequency between these two oscillators is again recorded. This procedure is continued until data are available indicating the amount of frequency deviation present between the standard oscillator and each of the resonator crystals. One of the remaining eight oscillators is used as a reference against which all of the other oscillators are compared. Thus, data are available for determining precisely any changes, relative to the system, which may occur in any oscillator or resonator in the system.

The reference oscillator is also instrumental in obtaining a continuous record of the frequencies of the three standard oscillators at the WWV installation. Automatically, the main, standby, and spare oscillators are successively switched at preset intervals to a low power v.h.f. transmitter. The signals are beamed to the NBS laboratory in Washington and the received signals are compared to signals derived from the reference oscillator.

A more precise and reliable temperature control of the ovens enclosing the oscillators has been developed. Essentially, the oven comprises four concentric cubical chambers. The center chamber holds the oscillator unit, and the space of the next and outer chamber is filled with felt insulation. An air-chamber containing mat heaters separates the insulated chambers. The outer heater, designed for coarse temperature control, is controlled by a

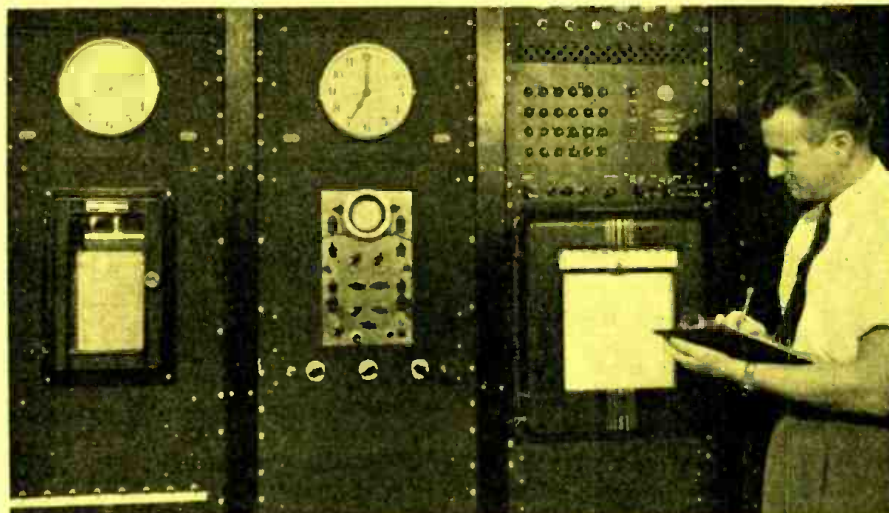

Frequency monitoring equipment of the NBS primary standard of frequency and time.

simple mercury thermostat. Control of the inner heater, designed to respond to very small changes in temperature, is achieved by using a network in which the heater element is part of the sensing circuit. In effect, one pair of arms of a resistance bridge is made up of wire with a high temperature coefficient, and the other pair is made up of wire of negligible temperature coefficient. Current through both pairs of wires supplies the necessary heat. An oscillatory circuit, composed of the bridge connected between the input and output of a high gain amplifier—essentially a feedback loop—controls the temperature. When the temperature is near the desired value—the bridge being slightly unbalanced—the amplifier is in a stable condition. As the outer temperature of the oven decreases, the bridge becomes further unbalanced and the amplitude of the output oscillations increases so as to supply more current to the bridge wires and, consequently, more heat to the oven. This condition will continue until the temperature regains the operating assigned value. Under normal room conditions, the temperature is controlled to better than 0.001°C .

The temperature-control oven for the eight resonator crystal units is constructed with six concentric cubical chambers. All eight crystals are enclosed in the one oven and the temperature control is achieved with mercury thermostats connected to both the inner and outer heaters. Inner temperature variation is less than 0.005°C for average variations in room temperature. The standard oscillators at the NBS transmitting station in Beltsville are installed in a room approximately 6 feet on a side built about 25 feet below the ground. The entire room is temperature- and humidity-controlled.

Each of the basic oscillators is equipped with an individual power sup-

ply and improved filter in order to achieve better regulation and control. The supplies all have plate and filament batteries that are continuously float-charged, and in the event of an a.c. power failure, they can carry the full load for many hours.

In order to monitor the time signals generated by the frequency standard accurately, one of the NBS standard oscillators is used to drive a synchronous clock. The 100-kc. output of each oscillator is electronically divided to a frequency suitable for driving a spark chronograph and chronoscope. The instruments are designed so that the

(Continued on page 30)

Primary resonator frequency standard.

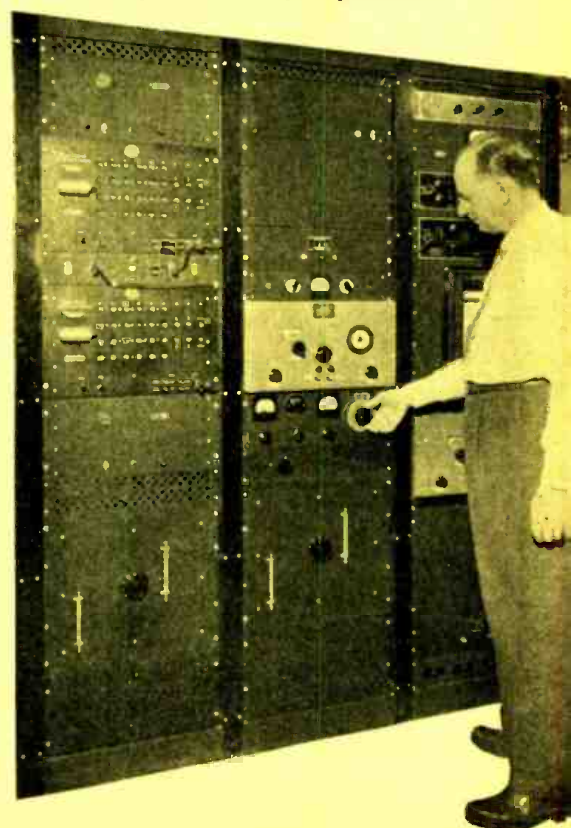

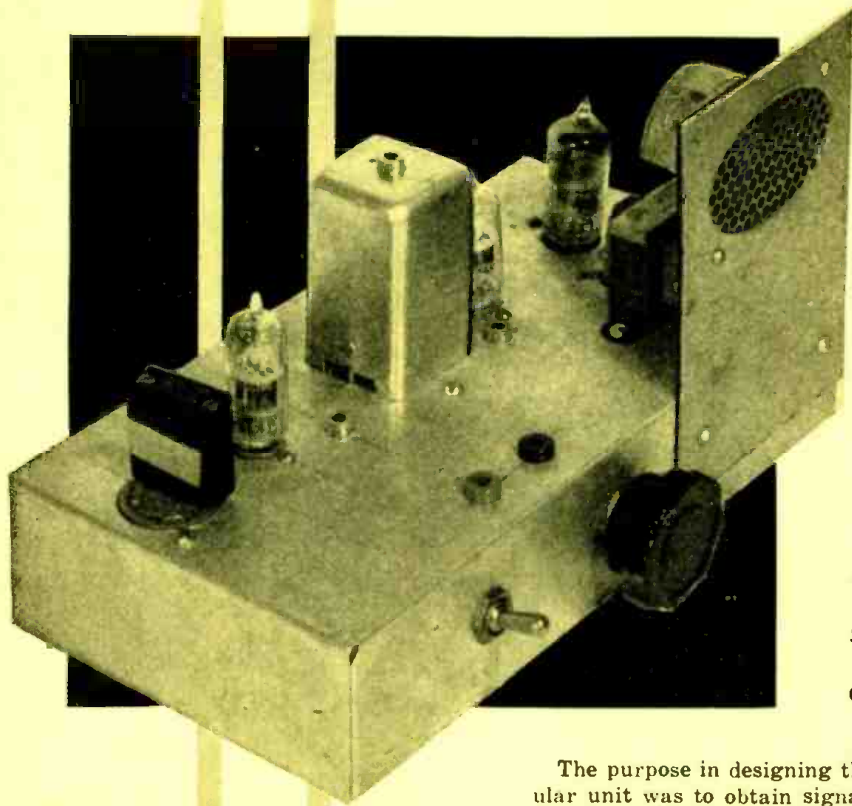

Fig. 1. Over-all view of the calibrator, showing location of controls and components.

By J. F. STERNER

Tube Dept., Radio Corp. of America

THE frequency calibrator described in this paper is a relatively simple calibrating device having a high degree of accuracy. It has been developed for use in u.h.f.-v.h.f. signal generators for both development laboratories and technical service shops. This calibrator may be used for determining the frequencies of unknown signals and for the production of usable signals from at least the tenth subharmonic to the harmonic more than one hundred times the fundamental of the crystal-controlled reference frequency.

Fundamentally, the calibrator consists of a crystal-controlled oscillator circuit, a frequency-multiplier circuit, a lock-in oscillator, a germanium-diode detector and mixer, a germanium-diode detector, and a two-stage audio amplifier. Novel features incorporated in the calibrator are an LC multivibrator which locks in with the crystal oscillator at one-tenth the crystal frequency, a "bumper" circuit in the cathode of the lock-in oscillator which increases the output at frequencies that are direct multiples of the tenth subharmonic of the crystal frequency, and a one-tube, two-stage amplifier utilizing the pentode-triode type 6X8.

*This article is based on a paper presented at the National Electronics Conference which was held October 29, 30 and November 1, 1952.

WIDE RANGE FREQUENCY CALIBRATOR*

An unusual circuit is used to provide subharmonics and harmonics of a 2.5-mc. crystal over the range of 0.25-250 mc.

The purpose in designing this particular unit was to obtain signals having relatively even amplitude throughout the range of 0.25 mc. to 250 mc. from the harmonics of a 2.5-mc. crystal oscillator and a 0.25-mc. lock-in oscillator. It was also considered desirable to provide a method of detection having adequate sensitivity for determining the frequency of unknown signals that may be applied to the calibrator at levels of 100 millivolts or more. The 100-millivolt figure was a minimum sensitivity figure established for 100 milliwatts of audio output at 1000 cycles.

Figure 2 is a block diagram showing the basic arrangement of the three-tube frequency calibrator and its sectional functions. At the bottom left-hand side is the 2.5-mc. crystal oscillator, and adjacent to it is the frequency multiplier amplifier. Directly above the crystal oscillator is the lock-in oscillator, and adjacent to that is the 1-mc. "bumper" circuit. The output voltages of all four of these circuits are combined and fed into the crystal mixer and detector stage. The combined signals, after passing through the attenuator stage, are then available as a marker output. When an external signal input is applied to the attenuator, it is rectified and heterodyned at the

mixer stage with the composite signal from the oscillators. The resulting beat-frequency signal passes through the two-stage audio amplifier and can be heard from the speaker.

Crystal Oscillator and Multiplier

Figure 7A shows the circuit utilizing the twin-triode type 6J6 for generating the fourth-harmonic 10-mc. signal. The 2.5-mc. oscillator using one triode section of the 6J6 is a "Miller" type oscillator. A trimmer capacitor is placed across the crystal to provide a small degree of adjustment for "zeroing in" on a primary standard signal, such as radio station WWV, during the initial adjustment of the calibrator. The second triode section of the 6J6 is a conventional multiplier stage with the plate circuit tuned to 10 mc. Sufficient driving voltage is applied to the grid of this section so that the harmonic output is about the same as that appearing in the plate circuit of the 2.5-mc. oscillator tube. Other twin triodes, such as the 12AT7 or the 6BQ7, produce about the same performance.

Figure 7B shows an alternate oscillator-multiplier circuit using the miniature pentode type 6AU6. This circuit works effectively, but appears to be more subject to variations in output activity from one crystal to another for a given fundamental and harmonic output. In addition, a high value of screen voltage was required to produce the same voltage level at 2.5 mc.

Lock-in Oscillator and "Bumper"

The lock-in oscillator circuit, together with the "bumper" circuit in the cathode, is shown in Fig. 4. Except for the addition of the tuned circuit in

Fig. 2. Block diagram of the calibrator.

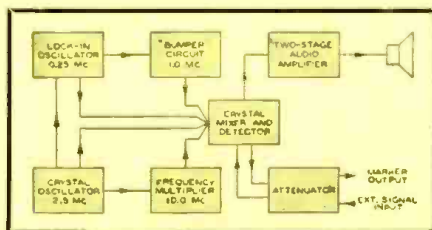

the cathode, this is a conventional oscillator circuit of the multivibrator type. The free-running frequency of the oscillator is approximately 0.25 mc. The 2.5-mc. synchronizing voltage from the crystal oscillator is injected at the cathode of the lock-in oscillator. It was found experimentally, however, that synchronization was just as effective with the synchronizing voltage applied to either the control grid or the cathode. Before the addition of the 1-mc. tuned circuit, the amplitude distribution of the higher frequency harmonics of the 0.25-mc. signal showed a definite increase every 2.5 and 10 mc. These increases were attributable to normal sideband distribution resulting from modulation in the crystal diodes and modulation of the 2.5-mc. oscillator circuit from the 0.25-mc. oscillator due to the capacitive coupling between circuits. The 0.25-mc. current of the two triode sections of the 6J6 flows through the cathode network which consists of the cathode-coupling resistor and the tapped portion of the tuned coil in the "bumper" circuit. Resonant frequency of this circuit is 1.0 mc. The 0.25-mc. current flow causes the circuit to oscillate at its natural frequency of 1 mc. This frequency is determined by the Q , L , and C of the tuned circuit. The amplitude of the 1-mc. voltage is largely dependent upon the coupling factor of the network. Even though the 0.25-mc. oscillator has a tuned circuit for controlling the 0.25-mc. free-running frequency, it also has a tendency to develop considerable harmonic voltage.

Adjustment of the 0.25-mc. lock-in oscillator and the 1.0-mc. "bumper" circuit is relatively simple and can be accomplished by loosely coupling some of the output voltage from the 1.0-mc. circuit to the antenna input of a communications receiver tuned to that frequency. The signal heard when the c.w. oscillator of the receiver is turned "on" is quite rough. Under some conditions, particularly when it is out of synchronization with the 2.5-mc. crystal oscillator, it may sound like random noise. As the 0.25-mc. circuit is adjusted, the signal will appear to jump into synchronization at 1 mc., at which time a clean c.w. note will be heard. Adjustment of the 1-mc. "bumper" circuit is made by simply tuning it for maximum signal with the receiver tuned to 1 mc.

Figure 3 is a photograph of the voltages appearing at the cathode of the 6J6 in the 0.25-mc. oscillator circuit. The relative amplitudes of the signals at 0.25, 1.0 and 2.5 mc. can be seen. (It will be noticed that the amplitude of the 1-mc. signals is only about 10 or 15 per cent greater than that of the 2.5-mc. periods. This difference in amplitude is due to the frequency-response

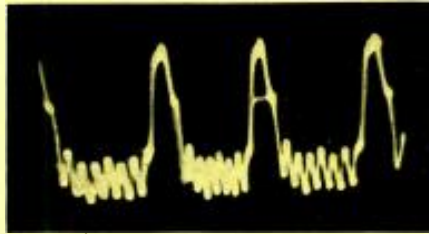

Fig. 3. Waveform of voltages at the cathode of the 6J6 in the 0.25-mc. oscillator circuit (Fig. 4).

characteristics of the oscilloscope used for photographing. In this oscilloscope, the 1-mc. response was down 6 db from that at 0.25 mc.)

Mixer-Detector Circuits

Figure 5 shows the germanium-crystal mixer-detector circuit. The four signals, at 0.25, 1.0, 2.5, and 10 mc., are coupled through isolating capacitors to the anode of a 1N34 crystal diode. Non-linear characteristics of the crystal diode working into a reactive load provide a voltage output that is fairly even at all frequencies up to 250 mc. The potentiometer shunted by the capacitor forms the load across which an audio beat frequency is developed when an external signal is introduced. A second 1N34 crystal diode in series with the external signal functions in a manner similar to the first 1N34 except that its load includes the attenuator potentiometer as well as the load circuit of the first 1N34. The second 1N34 is used to reduce the loading effect that would be introduced if the impedance of an external signal source were applied directly across the first 1N34. Likewise, some control of the input voltage is obtained through the attenuator potentiometer. Application of external input-signal levels in excess of 100 millivolts will produce a noticeable one-half frequency beat. The level of this spurious beat will be down about 20 db or more from the correct one and can be easily recognized, particularly if the attenuator is used to maintain the level of the input signal at the minimum required for a given audio output level. In addition, the attenuator provides partial

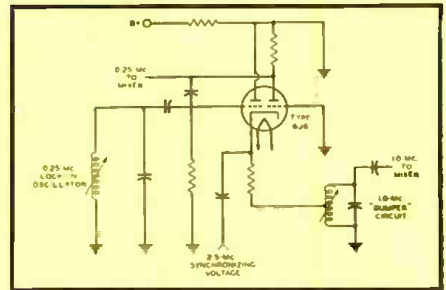

Fig. 4. Circuit of 0.25-mc. lock-in oscillator and 10-mc. "bumper."

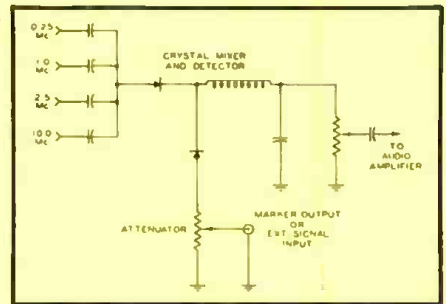

Fig. 5. Mixer-detector circuit.

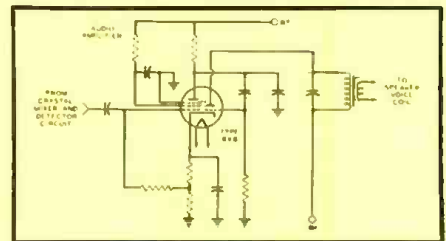

Fig. 6. Audio amplifier section.

control of the marker output voltage for application to an external detector, such as a receiver. The detector circuit of the first 1N34 does not include any direct resistive return for the diodes. The current-path return circuit is dependent on the ratio of the crystal diode front-to-back resistance. Although this ratio varies considerably with individual diodes, the variation appears to have very little effect on performance.

Audio Amplifier Stage

A schematic of the audio amplifier section is shown in Fig. 6. Because it

(Continued on page 31)

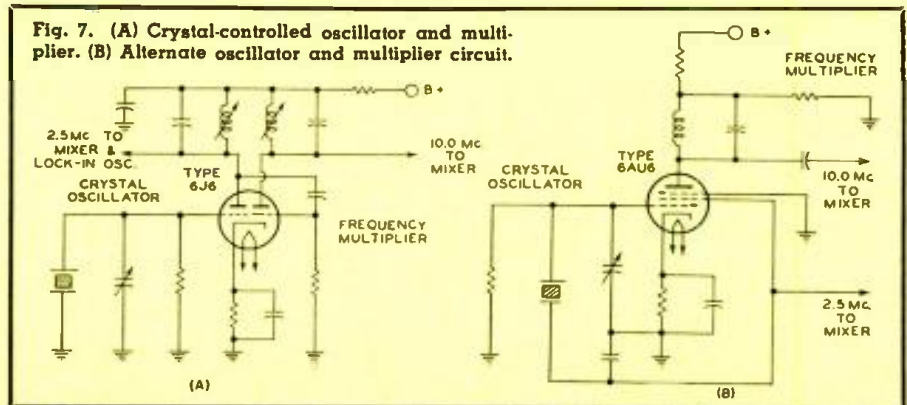

Fig. 7. (A) Crystal-controlled oscillator and multiplier. (B) Alternate oscillator and multiplier circuit.

UNIVERSAL RECORDER-REPRODUCER

By **DOUGLAS H. CARPENTER**

The La Pointe-Plascomold Corp.

Operating details of a compact tape machine which will record continuously up to 24 hours.

AN ENTIRELY new field in the art of audio transcription has been opened up by the invention of magnetic recorders. Their flexibility and economy of operation have proved them to be so outstandingly superior to former types of recorders that today tape recording is commonplace both in homes and in business. The armed forces were quick to recognize the many advantages of tape recorders and now use such equipment extensively. As a direct outgrowth of increasingly stringent military and commercial requirements, the *Press Wireless Model RRP-24* was developed. To this writing, RRP-24 is the only instrument with a compact tape assembly that will record automatically and without attention for a complete 24-hour period.

The secret of the long-playing feature is directly related to the special recording medium employed, and to the rather ingenious motor drive and rewind system. Figure 2 is a simplified diagram of the basic elements comprising the recording-reproducing assembly and speed change mechanism. The recording medium used with the RRP-24 is an iron oxide coated cellulose acetate magnetic tape that is $8\frac{1}{2}$ " wide and 206' in length. An automatic reversing switch simultaneously changes the direction of tape travel and the amount of torque of the drum control motors; the total operation is accomplished in less than $1/40$ of a second. One roll of tape, capable of storing 24 hours of recorded intelligence, is only 3" in diameter and weighs only $2\frac{1}{2}$ pounds.

The master recording head is mounted on a close-tolerance, mechanically secure carriage which also supports the two erase heads. An open view of the recording head and carriage assembly can be seen in Fig. 5. The two reproducing heads are positioned at the desired track by a control

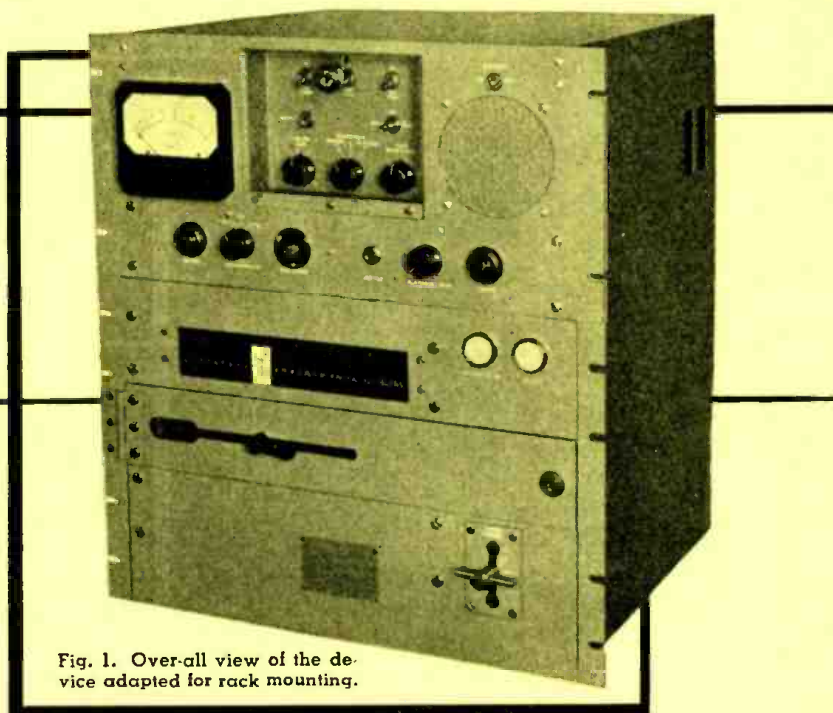

Fig. 1. Over-all view of the device adapted for rack mounting.

at the front panel. Each recorded track is .030" wide with .020" spacing between adjacent tracks. The carriages travel automatically from track to track on a special lead screw in such a way that the finished recording is a continuously folded track. To further clarify the exact nature of a completely recorded tape, an explanation of the mechanical and electrical control circuits is necessary. Reference to the block diagram, Fig. 7, will simplify the explanation of the control and switching circuits.

When the power switch is on, the two torque motors are energized and exert torques in opposite directions on the winding spools, keeping the tape taut on the recording drum. The Ledex cam operates switch S_{107} which alternately feeds each motor through a dropping resistor. This reduces the voltage across the torque motor and op-

poses the direction of paper travel, placing less drag on the drive motor. Included in the motor control circuit is a full-wave bridge type rectifier supplying d.c. for the drive motor armature and for a rotary solenoid. When power is applied to the motor circuit, a relay closes, shorting out the motor drive dropping resistor and placing the entire d.c. across the motor armature. This provides greater starting torque until a timing condenser charges and the relay opens. When the switch S_{103} is open, a type 12AU7 tube in the electronic motor control circuit tends to cut itself off, limiting plate current to a value too small to close the reversing relay. S_{103} is actuated by a silver strip located at each end of the tape. If S_{103} is closed, the 12AU7 is left with zero bias and plate current closes the reversing relay. The first section of this relay applies d.c. voltage to a rotary solenoid which in turn actuates mechanically switches S_{101} , S_{102} , S_{104} and S_{107} .

Field windings of the motor are connected so that when the first is across the line, the second is in series with a condenser and a resistor. The first field voltage leads the second by some angle less than 180 degrees. When S_{104} is actuated by the Ledex cam, the two field coils are electrically interchanged, reversing the motor. At this instant, the second section of the reversing relay shorts out the dropping resistor, giving the motor an additional starting boost

Fig. 2. Simplified diagram of the recording-reproducing system showing the action of the speed change mechanism.

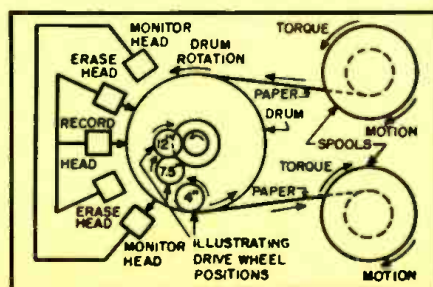

in the reverse direction as was done when the motor was originally started. S_{103} is closed only for an instant as the tape stops and reverses direction. The control circuit then assumes its standby condition until the other silver patch at the opposite end of the tape initiates the same operation again.

Relative direction of spools and drum travel for an arbitrarily chosen drum rotation is indicated in Fig. 2. Each spool has its own torque motor, and these motors never change their sense of torque. However, less voltage is applied to the torque motor opposing paper travel by means of S_{107} . The Ledex cams revolve $\frac{1}{4}$ -turn each time a silver patch trips S_{103} , actuating the four microswitches, S_{101} , S_{102} , S_{104} and S_{107} , as previously explained. The combination of the motor control and switching circuits just described determines the direction of tape travel. In conjunction with the lead screw, the recording head carriage assembly shifts the recorded track .020" at each tape reversal.

The exact nature of the "looped" end of the recorded track and the time required for the complete reversal are most important if the recorded intelligence is to be continuous. If one track is being recorded in the longitudinal tape direction (206 feet), the reversal time must be practically instantaneous or loss of intelligence will occur. Two different actions occur at the end of each recorded track. The motor control and switching circuits reverse the direction of tape travel in less than $\frac{1}{40}$ of a second, and the lead screw assembly causes the recording head to inscribe a circular or "looped" end which connects the original and new track. Recording direction and tape travel have reversed, but no loss of recorded data can occur as the time involved is fractional com-

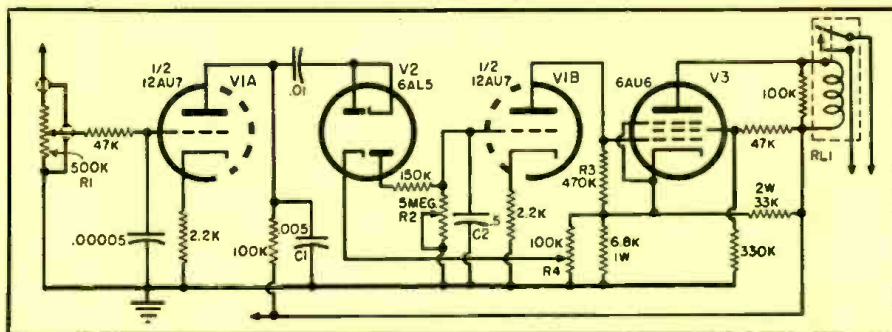

Fig. 3. Schematic diagram of the voice-operated relay portion of the circuit.

pared to any recorded frequency. This process in the case of continuous recording repeats itself every ten minutes (24-hour speed), and a fully transcribed tape would contain 144 such tracks .030" wide separated from each other by .020".

A coarse index (see Fig. 5) attached to the carriages references to a 24-hour scale calibrated in ten-minute segments. There is also a fine index which consists of a helix drawn indelibly upon the recording medium. As this line progresses laterally, being a spiral, it indexes to a ten-minute scale divided into increments of ten seconds. Accuracy of location of an earlier recording is better than ten seconds in 24 hours. To preclude the necessity of close supervision while recording, a compressor amplifier is incorporated in the audio input system. Its threshold level is preset to prevent a material increase in gain in the total absence of a signal. The audio input circuits permit both microphone and 600-ohm line connections.

Normal recording speed position for the 24-hour condition is 4" per second with a usable frequency range of 200—5000 cps. The speed change control lever is located at the lower right-hand

side of the instrument, and permits a selection of speeds of $7\frac{1}{2}$ " and 12" per second. The high frequency response is increased to 7000 and 8000 cps respectively. Such an arrangement means that the RRP-24 can be instantly converted from speech recording to the wider ranges of music, high speed telegraph, etc.

The playback system is separate, and is comprised of two reproducing heads and a self-contained amplifier which develops three watts of audio output power. Control is automatic or manual, and can be effected by means of a foot switch. The reproducing head may be positioned to monitor immediately behind the recording head (on the same track) or, if it is desired, the head can be repositioned to reproduce a previously recorded track without disturbing the continuity of recording. Two high gain stages precede an inverter stage in the playback amplifier strip. Signal is introduced by either the monitor head (in monitoring) or the record head (in playback). The input incorporates a series resonant trap which removes the 30-kc. erase bias signal.

When intermittent recording is desired, an integral fast-acting, voice-operated relay (v.o.r.) may be switched

Fig. 4. Rear view of the amplifier section.

Fig. 5. Front view of the recorder section.

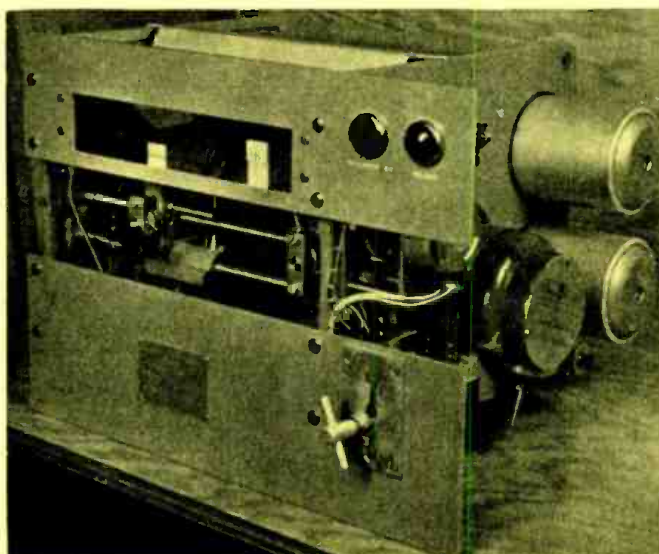
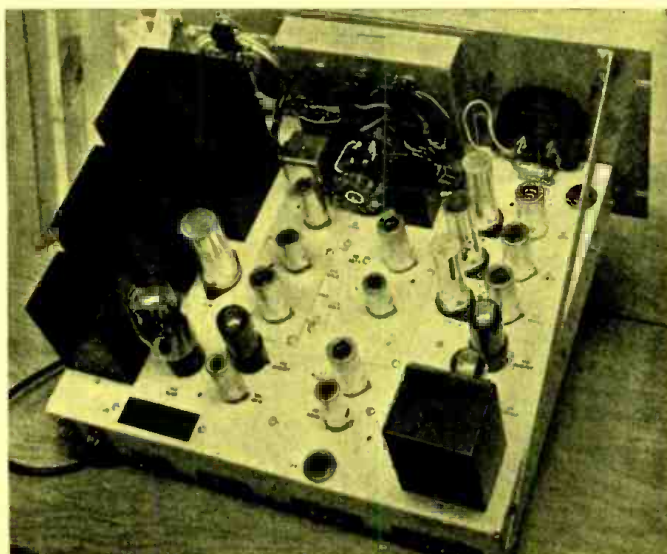

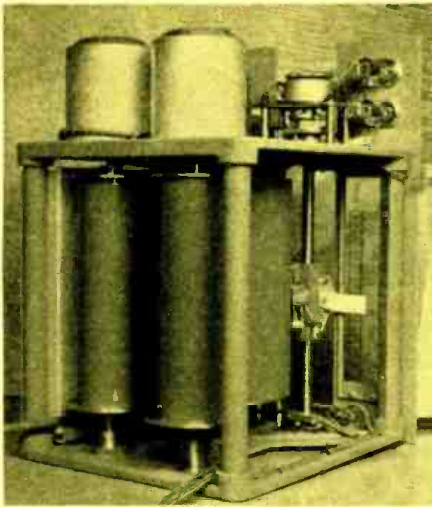

Fig. 6. Back view of the recorder section showing the tape rolls.

into operation. With such operation, one loading of tape will last well beyond the 24-hour period. The machine will shut down a few seconds after signals cease and will not restart until the input circuit receives another impulse. For this type of operation, the time element of starting is a fraction of a syllable and the stopping time is adjustable up to seven seconds. The threshold level control can be set to prevent random operations from line noises or background sounds picked up by the microphone. The voice-operated relay section is located on the amplifier chassis. The first v.o.r. stage V_{1A} (see Fig. 3) taps its signal from the v.o.r. sensitivity control R_1 . This stage renders the v.o.r. circuit essentially

responsive to low frequency components because of C_1 (.005 μ fd.) shunting the output of V_{1A} . On negative peaks of the signal voltage, V_{2A} conducts in series with V_{2B} and charges C_2 . This biases V_{1B} negatively and cuts off plate current. If the signal is absent, C_2 discharges through a variable resistor R_2 and brings V_{1B} back to the conducting state. This "off-on" action of V_{1B} is reversed to "on-off" in V_3 by means of R_3 , across which a voltage switches from 0 to a relatively large negative value with respect to the cathode of V_3 . Hence, with signal, relay RL_1 contacts close and permit the motor to run. Without signal, the contacts open, stopping the motor.

R_2 is a preset control through which C_2 discharges, thus determining the time delay between signal stoppage and conduction of V_{1B} . R_4 sets a threshold value for conduction through V_{2A} , and is adjusted so that noise does not cause operation of the relay in the absence of signal.

The 30-kc. erase bias voltage is generated by a conventional Hartley oscillator. This voltage is mixed with the signal before recording. The output of the oscillator is fed to the record head and also to an amplifier stage, where it is amplified and fed to the erase head.

Bias voltage is required for much the same reason as in biasing an electronic tube, i.e., in order to operate in as linear a manner as possible. In this case, linear operation pertains to the magnetization curve of the oxide-coated sheet. Erasing is accomplished

by feeding a high frequency voltage to the erase head in order to create a high intensity field across its gap. In moving through this field, a magnetic substance experiences quick changes of state which are represented by a series of rapidly diminishing hysteresis loops, approaching and realizing practically a demagnetized condition. During playback, S_1 (Fig. 7) cuts off plate voltage from the oscillator and its amplifier, thus removing the bias and erase signals from the circuit.

The record amplifier consists of three amplification stages. This section is operative when S_1 is in positions 1 or 2. In position 1, the 600-ohm balanced input signal is fed through an attenuator pad to the input of the transformer. The output is fed through the record gain control to the first amplifier stage. In position 2, the 500-ohm balanced input microphone signal is fed directly to the input transformer, bypassing the attenuator pad. The output of the second stage is supplied through a level control to a separate amplifier stage in order to provide signal for the operation of the db meter, the v.o.r. and a.v.c. circuits. One half of a dual triode rectifies the output of this separate amplifier stage, developing a negative voltage across the diode load. This voltage is filtered, providing a negative bias to the first stage. The a.v.c. switch can be used to ground this circuit when S_1 is in position 1.

After the signal to be recorded goes through the second stage, it is fed to a frequency compensating network. In

Fig. 7. Simplified block diagram of the complete unit, showing functions of various components.

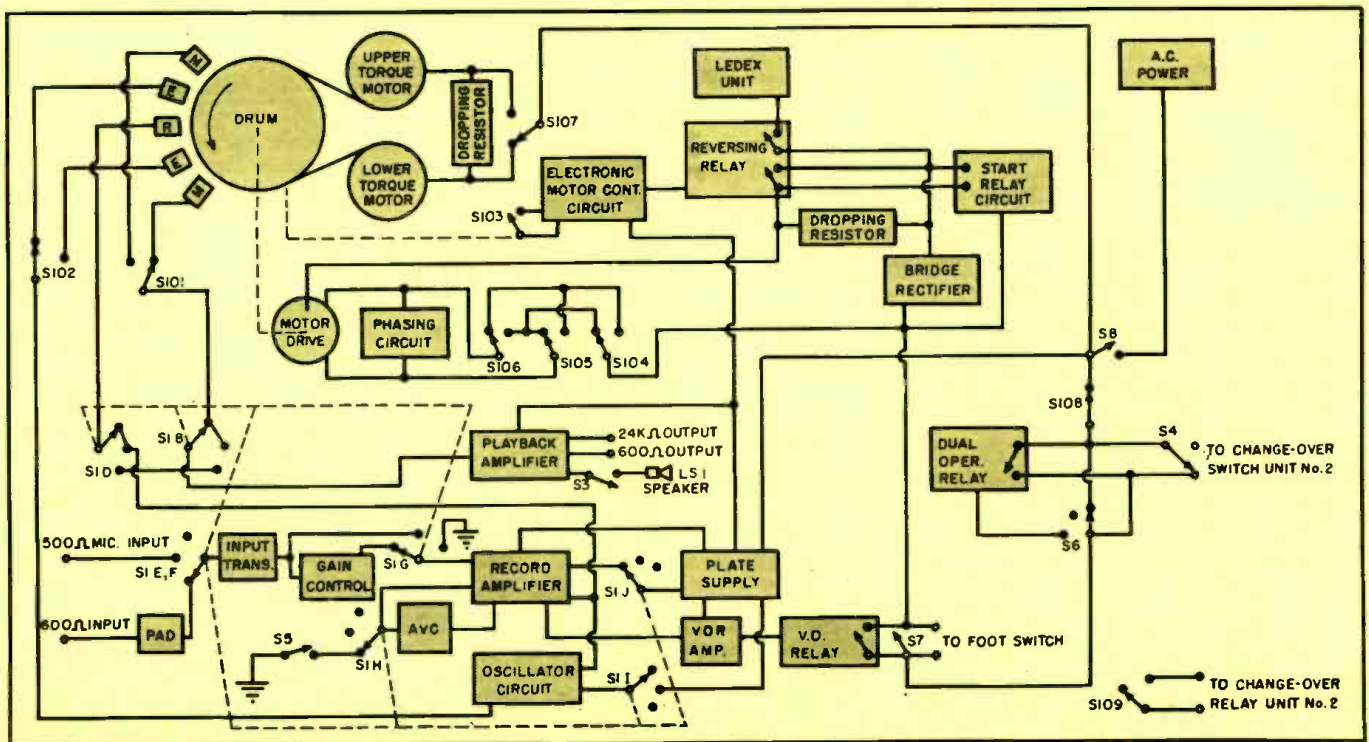

position 1 of S₂, corresponding in normal operation to a speed setting of four inches a second, the high frequency cutoff point of the amplifier response curve occurs higher in the frequency spectrum. In position 3, corresponding normally to a speed of 12 inches per second, the high frequency portion of the response curve is de-emphasized. Following frequency compensation, the signal is fed to a pentode power amplifier stage and finally to the record head.

To extend the recording time of the RRP-24 further, a second recorder may be connected to it by a simple patch cord. Both units must have the motor control switch set to "dual." The first unit can then be set in operation at the start of recording by pressing the momentary switch to "start." When the first unit is on the last vertical scan, the second unit will automatically take up the recording function, thus giving an overlap.

A remote indicating device such as a ringing bell or flashing light may be used to attract the attention of the operator when a machine that is recording has but ten minutes of recording time left.

The RRP-24 has been used to advantage for diversified applications, and it is a literal fact that new uses are being uncovered daily for this versatile instrument. Some of the general uses to which the RRP-24 has been adapted are: airport control tower and airline communications center master recorder, press and commercial communications monitoring and transmission, broadcast program monitoring, information storage in computer systems, unattended monitoring for detective and police work, programming control of industrial equipment such as the production of patterns on textiles, automatic telephone answering centers, etc.

Some of the newer uses for the RRP-24 include unattended broadcast of music for restaurants and business offices from a central control point. The multiple-speed selection feature allows recording at slow speed and retransmission at an accelerated rate, cutting down wire service and telephone line charges. A similar recording rate is required at the receiving end, which is in turn played back at normal speed for transcription purposes. Distribution of confidential messages on a national basis and international transmission of facsimile data can be greatly speeded up with an attendant cost reduction by the above process. A special version of the RRP-24 will simultaneously record 24 channels, making it a valuable asset to industrial and government laboratories concerned with analysis of multiple phenomena.



designed
by Microtran...
for transistor
circuitry

*Hermetically sealed transformers
available as stock items*

With miniaturization as a keynote these MICROTRAN transformers were designed specifically for Transistor Circuitry. Available in miniature, sub-miniature and micro-miniature sizes, dependent upon current, power, and frequency response requirements.

At MICROTRAN you will find a well staffed circuit design department prepared to assist you in your miniaturization problems. Our recent developments of H I "Q" audio transformers for single frequency applications have permitted substantial reduction in equipment complexity.

These ruggedized military type units are stock items. Immediate delivery on hermetically sealed and open frame units.

Open units are Resin impregnated to provide thorough protection from adverse climatic conditions and are supplied with flexible 3" color coated leads.

Standard MIL type cases for military applications are available on special order.

TRANSISTOR TRANSFORMERS

PART NO.	MIL TYPE	APPLICATION	PRIMARY IMPED.	SEC. IMPED.	LIST PRICE	
					M	SM & MM
*T1	TF1A10YY	Input-Line to emitter	500	500	\$14.50	\$14.15
*T2	TF1A10YY	Input-Hi impedance mike to emitter	50,000	500	15.70	14.15
*T3	TF1A15YY	Interstage-collector to emitter	50,000	500	15.70	14.15
*T4	TF1A13YY	Output-collector to line	50,000	500	15.70	14.15
*T5	TF1A13YY	Output-collector to speaker	50,000	6	14.50	14.15

* Add M Prefix to indicate miniature size, SM for sub-miniature size, MM for micro-miniature size. Size to be used depends on D.C. current, frequency response and power output requirements. Write for full details.

Write for catalogue w and name of
nearest representative



MICROTRAN® CO.

an affiliate of Crest Laboratories, Inc.

WHITEHALL BUILDING, FAR ROCKAWAY 91, N. Y.

NEW TUBES

SELENIUM DIODES

Two selenium diodes, Types 1S1 and 5U1, have been developed by *International Rectifier Corporation*, 1521 East Grand Avenue, El Segundo, Calif. Type 1S1 is rated for a maximum input of 26

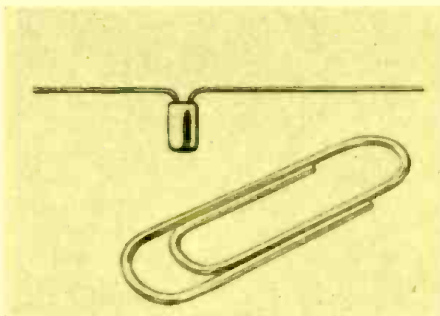

volts r.m.s. at 100-microamperes output, while Type 5U1 is rated for 130 volts maximum at 1.5 ma.

These new diodes augment the line of eight subminiature types currently being produced by *International Rectifier Corporation* for operation in an ambient temperature range of 50 to 100°C. Extremely small in size for ease in wiring into a crowded chassis, the units are completely encapsulated within a thermosetting plastic to protect them against adverse environmental conditions.

RADIAL-BEAM POWER TETRODE

The Eimac 4X150D, a radial-beam power tetrode, has been developed by *Eitel-McCullough, Inc.* Well suited for use in 28-volt electrical systems, this tube has a heater rating of 26.5 volts at 0.57 amperes. It was designed for



use in commercial and military aircraft and other vehicular operation.

Identical in size and shape to the Eimac 4X150A, the 4X150D power tet-

rode can be used with the 4X150A air-system socket. Like the 4X150A, it is operated as an oscillator, amplifier, or frequency multiplier, and has a plate dissipation rating of 150 watts in Class C telegraphy or FM telephony service.

Further information on the 4X150D can be obtained by writing to the Application Engineering Department, *Eitel-McCullough, Inc.*, San Bruno, Calif.

27" TV PICTURE TUBE

Development of a 27" rectangular television picture tube has been announced by the Tube Department of *General Electric Company*. The largest picture tube made by *G-E*, it is a mag-

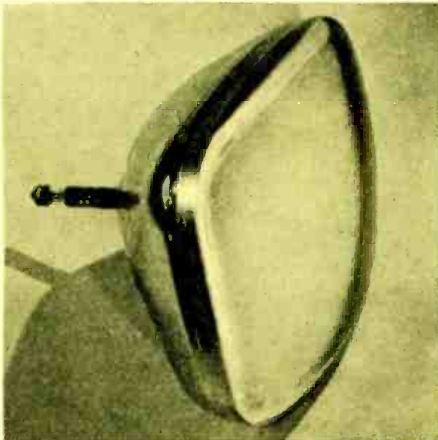

netic-focus, magnetic-deflection, all-glass tube. It features an aluminized backing on the screen which reflects light emitted from the back surface, thereby providing a picture which is up to 100 per cent brighter than a non-aluminized 27" tube at the same voltage, and consequently having greatly increased black and white contrast.

Type 27EP4 provides a 24" x 18½" picture. The length of the tube, from front to back, is less than 23 inches. Recommended operating conditions are: anode voltage, 16,000 volts; grid No. 2 voltage, 300 volts; grid No. 1 voltage, -33 to -77 volts; ion trap intensity, 38 gauss. Full details may be obtained from the *General Electric Tube Dept.*, 1 River Road, Schenectady 5, N.Y.

RCA TUBES

Half-Wave Vacuum Rectifier

Recently announced by the *RCA Tube Department*, Harrison, N. J., is the 6AX4-GT, a half-wave vacuum rectifier of the heater-cathode type. It is intended primarily for use as a damper

tube in horizontal deflection circuits of television receivers.

Designed to withstand negative peak pulses between heater and cathode of

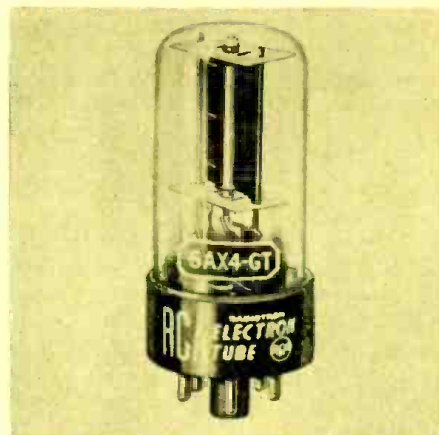

as much as 4000 volts with a d.c. component up to 900 volts, the 6AX4-GT provides flexibility in choice of deflection circuits. Heater rating for unipotential cathode is 6.3 volts at 1.2 amperes. Direct interelectrode capacitance (with no external shield) is 7.5 μfd.

Twin Diode—Medium-Mu Triode

The 12BF6 just introduced by the *RCA Tube Department* is a multi-unit miniature tube of the heater-cathode type containing two diodes and a medium-mu triode in one envelope. It is intended for use as a combined detector, amplifier, and a.v.c. tube in automobile radio receivers operating from a 12-volt storage battery.

The characteristics of the triode unit are such that it can be impedance-coupled or transformer-coupled to the



output stage. In either case, the triode unit can supply more than ample output with low distortion to drive a pair of 12V6-GT's operating at maximum plate voltage in the output stage of automobile receivers.

MEDIUM-MU TRIODE

The Los Gatos brand Type 254 medium-mu triode may be operated as a

Class B a.f. power amplifier, and as a Class C r.f. power amplifier—either plate modulated or unmodulated. The 5.0-volt filament is of the thoriated tungsten type and operates at 7.5 amp.

Type 254 has a maximum average plate current of 255 ma., a maximum plate voltage of 4000 volts, and an average amplification constant of 25. A data sheet is available from *Lewis and Kaufman, Inc.*, 76 El Rancho Avenue, Los Gatos, Calif., which illustrates the tube and provides operating curves for average static characteristics.

SUBMINIATURE TRIODE

Raytheon Manufacturing Company announces a low microphonic subminiature triode designated as CK6247 (formerly known as CK628). When this tube is subjected to vibrational acceler-

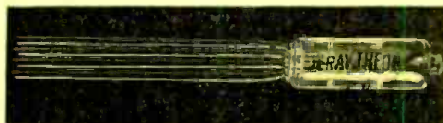

ation of 15G at 40 cps, it has a maximum noise output of 2.5-millivolts a.c. across 10,000 ohms in the plate circuit. The normal amplification factor rating is 60, and the mutual conductance rating is 2500 micromhos with a maximum allowable plate voltage of 275 volts.

Technical data and further information may be obtained from *Raytheon Manufacturing Company*, Technical Information Service, Special Tube Section, 55 Chapel Street, Newton 58, Mass.

CATHODE-RAY TUBES

Development of a line of cathode-ray tubes employing electrostatic focus and magnetic deflection has been announced by the Cathode-ray Tube Division of *Allen B. Du Mont Laboratories, Inc.* Designed primarily for radar installations, the new tubes are: B1036P—, B1038P—, B1039P—, B1040P—, and B1056P—. They replace Types 5FP—, 10KP—, 12SP—, 12DP-A, and 7MP—, respectively.

In these tubes an electron lens obviates the necessity of a focus coil and requires only a low potential source of low power for focusing. This lens produces a more uniform spot size across the face of the tube, and thus resolution is improved considerably. Reduced power requirements mean fewer components.

Du Mont states that it is now possible to substitute electrostatically focused tubes for most magnetically focused types upon request. Further information may be obtained by writing to the Technical Sales Department, *Allen B. Du Mont Laboratories, Inc.*, 1500 Main Avenue, Clifton, N. J.

HICKOK TEST INSTRUMENTS

Always in Stock at
HUDSON RADIO & TELEVISION CORP.

World Famous for Accuracy and Dependability

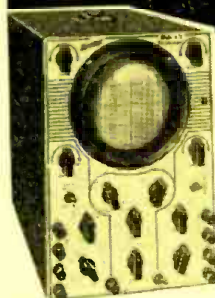

New!
MODEL 670 5" OSCILLOSCOPE

High sensitivity unit with DC amplifier range to 500 kc; usable to beyond 5 mc. Excellent square wave response. Sensitivity, 15 mv rms/inch. Recurrent linear sweep, 3 to 50,000 cycles. Provision for Z-axis modulation. Has demodulator circuit for viewing modulation on RF signal. Reversing switches for both horizontal and vertical deflection. In steel case, 9 3/4 x 12 1/4 x 18" Shipping weight 35 lbs. Net **\$229.00**

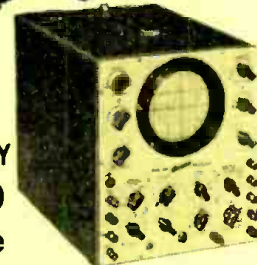

LABORATORY MODEL 640 Wide-Range 5" OSCILLOGRAPH

An extremely versatile industrial and laboratory instrument. Wide band amplifier. DC response is 0 to 4.5 mc, down 3 db. Built-in peak-to-peak calibrating voltages, 100, 10, 1, .1 volts. Sweep expansion, 6 times. Recurrent and driven sweep, 2 to 30,000 cycles. Shielded and shock mounted. Portable steel case, 14 x 11 1/2 x 19". Shipping weight 44 lbs. Net **\$355.00**



MODEL 292X SIGNAL GENERATOR

Frequency Coverage: 125 kc to 220 mc. Calibrated Output: Less than 1 microvolt, up to 100,000 microvolts. Leakage less than 0.2 microvolt. Net **\$266.00**

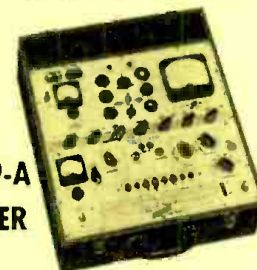

MODEL 539-A TUBE TESTER

Highly accurate engineers' model . . . Measures mutual conductance in micromhos. Permits choice of 3 AC signals, 0.25, 0.5, or 2.5 volts. Separate AC meter measures line voltage at all times; separate voltmeter measures grid bias. Provision for plate milliammeter. Portable case, 16 3/4 x 18 3/4 x 7 1/2". With test leads and instructions. Shipping wt. 39 lbs. Net **\$271.50**

New! Model 650 Video Generator . . . Net **\$310.90**

New! Model 680 TV R.F. Marker and Crystal Calibrator . . . Net **\$129.50**



Call HUDSON For ALL HICKOK Test Equipment . . . Complete Stocks . . . Prompt Delivery!

FREE! New 1953 HUDSON CATALOG

Everything in electronics at your fingertips in this complete new buying guide. INCLUDES the latest JAN CROSS-REFERENCE GUIDE and all types of fully approved JAN COMPONENTS. Over 196 pages of the latest and largest selection of Industrial Electronic Equipment, Tubes, Test Instruments, Recording and High Fidelity Audio and Sound Equipment. Complete lines. Wide selection. All Standard Makes in Stock for Prompt Delivery at LOWEST PRICES!

One Call for All!

Send for your FREE Copy Today

HUDSON
RADIO & TELEVISION CORP.

48 WEST 48th ST. • 212 FULTON ST.

New York 36, N. Y. New York 7, N. Y.

Circle 6-4060

Hudson Radio & TV Corp. Dept. N-12
48 West 48th St., New York 36, N. Y.

Please send FREE copy 1953 Hudson Catalog
 Ship the following:

Name Title

Firm

Address

City Zone State

NEWS BRIEFS

CAPACITOR TESTING

In this photograph, an operator at the Vergennes, Vermont, plant of *Simmonds Aerocessories, Inc.*, is testing small capacitor units for accuracy before they are used in assembling Pacitron fuel gages, test equipment and other devices



for aircraft applications. Exacting requirements in the production of equipment of this kind make it essential to check even the smallest components to make sure that they comply with rigid specifications.

TV'S FUTURE IN INDUSTRY

In a technical paper presented at the Fall General Meeting of the AIEE at New Orleans, La., G. Holmes Wilson of *Diamond Power Specialty Corp.*, Lancaster, Pa., predicted that the future use of television in industry probably has a greater potential than that of commercial (entertainment) television. With the Utiliscope, industry's counterpart of the commercial television apparatus, already being used in some 200 different industrial applications, he pointed out that "the surface has hardly been scratched."

Mr. Wilson said that television can help perform the following basic functions in industry: (1) reduce accidents, (2) reduce operating costs, (3) reduce capital investment, and (4) under certain conditions provide greater intelligence than can be gained by direct observation.

1953 IRE PRESIDENT

Dr. James W. McRae, vice president of *Bell Telephone Laboratories*, has been

elected president of the Institute of Radio Engineers for 1953. He succeeds Dr. Donald B. Sinclair, chief engineer of the *General Radio Company*, as head of this international society of over 30,000 radio engineers and scientists.

Dr. McRae first joined the staff of *Bell Telephone Laboratories* in 1937 to do research work on transoceanic radio transmitters. During World War II he served for three years in the U.S. Army Signal Corps, where he attained the rank of colonel and received the Legion of Merit for his services. He then returned to *Bell Telephone Laboratories* and in 1951 was appointed vice president in charge of the systems development organization.

TRANSISTOR TELEPHONE UNITS

A trial installation of transistor units is being made at Englewood, N. J., as a part of the customer long distance dialing service introduced there by the *Bell System* in 1951. The transistors will be used in oscillators to generate the electrical signals by which the numbers of a called telephone are sent from one central office to another.

Shown in the photograph are F. E. Blount (left), who helped develop the oscillator, and Dr. William Shockley (right), who directed *Bell Telephone*



Laboratories' transistor research project. Mr. Blount holds one of the transistors, six of which are used in each oscillator.

With this new transistor equipment—much smaller and less expensive than the vacuum tube units previously employed—the signalling equipment, instead of being centrally located, can be

placed exactly at the points where it is needed.

FLEXIBLE COIL FORMS

Now available from the *Precision Paper Tube Company* are coil forms with special flexible flanges—a new advancement in coil form construction—

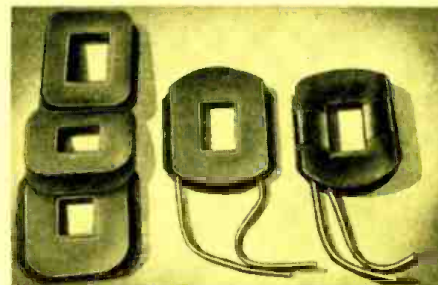

which completely eliminate taping operations on motor field coils. Known as "Flexiform" bobbins, they cut both production time and labor requirements in coil installation—a highly important factor in speeding up assembly lines, especially where mass production techniques are desirable.

"Flexiform" bobbins can be readily supplied in shapes and sizes as specified. Flanges are of flexible rope paper while dielectric kraft paper is used for the core. For further information, write to the *Precision Paper Tube Company*, 2035 W. Charleston Street, Chicago 47, Ill.

LARGER QUARTERS

Consolidated Engineering Corporation has opened new and larger offices for its subsidiary company, *CEC Instruments, Inc.*, at 285 Madison Avenue, New York, N. Y. Walter J. Beagan, New York and Northeastern U. S. manager, will be in charge.

These offices will handle sales and services for *Consolidated Engineering's* line of analytical instruments for science and industry, including the company's newly announced electronic computer and automatic data handling equipment.

"DRAG DISTORTION"

According to a study made by Jacob Rabinow and Ernest Codier of the National Bureau of Standards, if a phonograph needle can move longitudinally (tangentially) with respect to the groove of an ordinary laterally recorded disc, the needle will not follow perfectly the lateral excursions of the groove, and "drag distortion" will result. In the playing back of recorded music, this distortion may apparently result in spurious tones of greater amplitude than the tones originally present.

It was not practical to measure electrically the amount of distortion caused by this longitudinal motion because of

the simultaneous presence of other forms of distortion. It was possible, however, to determine the magnitude of the longitudinal motion, and by computation to arrive at the character and amount of distortion attributable to this motion.

This work has been reported in detail, with mathematical analysis, in the *Journal of the Acoustical Society of America*, Volume 24, No. 2 (March, 1952).

WEATHER SENSING EQUIPMENT

Motorola, Inc., 4545 W. Augusta Blvd., Chicago 51, Ill., has announced the development of a new weather sensing unit known as the "Snow Detector." Designed primarily for the de-icing of microwave antennas, this unit may be used wherever severe icing conditions and snowfall impair the operation of moving parts. An integral heater melts the snow and ice collected in the "bowl."

Fully automatic, the detector will turn on the heating elements whenever

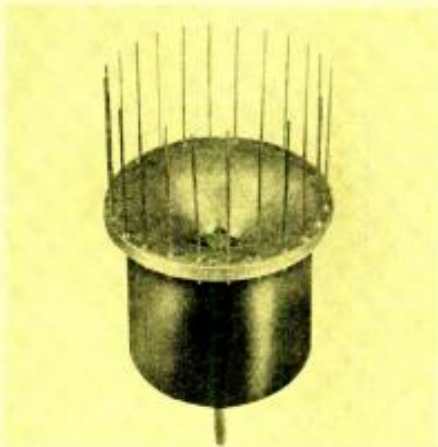

icing conditions exist. Up to 30 amperes at 117 volts a.c. can be switched without external relays. The heating elements will then remain on until the icing hazard is past. No power is consumed at higher temperatures.

CAR RADIO SYSTEM

One of *Motorola, Inc.*'s 450—460 mc. two-way radio systems for automobile emergency radio service has been installed by the District of Columbia Division of the American Automobile Association in Washington, D. C., and was recently given its initial test. The test car was first driven over the areas of northwest Washington and part of Maryland; two-way communication was maintained over the entire area. The car was also driven along the banks of the Potomac River and across the Chain Bridge to Virginia, with no dead spots noted in the Virginia area.

The base station transmitter is installed atop a 100-foot building in northwest Washington. It has a power output of 20 watts with an antenna

power gain of 8 db. The mobile unit also has a power output of 20 watts into a rooftop quarter-wave antenna.

RAYTHEON LABORATORY

Under construction at Bedford, Mass., is an electronics laboratory that is expected to be one of the most advanced laboratories ever built for the development of electronics equipment used in conjunction with aircraft. Operation of the laboratory, which is being built by *Raytheon Manufacturing Company*, will be concerned almost exclusively with research and development work for the U.S. Navy. To cost nearly \$2,000,000 and to have 100,000 square feet of floor space on two floors, the new plant will be situated on about 15 acres of land at the north end of Hanscom Airfield.

HIGH SPEED CALCULATOR

By March, 1953, the Armour Research Foundation expects to have installed and in operation a "card-programmed calculator" which will be available to serve business and industry in the Chicago area.

The new calculator, now on order from *International Business Machines Corporation*, is a digital computer. The information necessary for the machine

to operate is fed into it on punched cards that provide the operator with a large number of possible operations. After the operator sets up the machine for a problem and specifies the operations he wants it to perform, the machine will not only carry out the operations but also make all the necessary decisions as to the sequence in which they should be performed.

CONSOLIDATED APPOINTMENTS

Two appointments have been announced at *Consolidated Engineering Corporation*—that of Dr. Wilson S. Brubaker as senior research physicist and that of Dr. Paul Brock as engineering mathematician. Dr. Brubaker will work mainly in the field of mass spectroscopy, while Dr. Brock has been assigned to the company's computer group.

Dr. Brubaker was at various times a member of the faculties at Miami University, Cal Tech, and Ohio State University. Before joining *Consolidated*, he served for nine years as section manager for the physics department of *Westinghouse Electric Corporation* in East Pittsburgh.

Dr. Brock formerly did computation work with the *Kellex Corporation* and served as senior mathematician for the *Reeves Instrument Corporation*. 

**CLOSE-TOLERANCE
CONSTRUCTION
PLUS...**

QUALITY CONTROL...
**brings you the best
in paper tubes**

PRECISION

PAPER TUBES



Made of the finest dielectric kraft, fish paper, acetate, or combinations, **PRECISION Paper Tubes** are die-formed under heat and pressure. Uniformity, strength, and light weight are assured. High manufacturing standards and rigid testing result in maximum insulation, heat dissipation, and moisture resistant characteristics.

Available in any shape, length, I.D. or O.D. Finished to your exact specifications.

**SEND TODAY FOR FREE SAMPLE AND REQUEST
NEW ARBOR LIST OF OVER 1500 SIZES.**

PRECISION PAPER TUBE CO.

2063 W. CHARLESTON ST.
CHICAGO 47, ILL.

Plant No. Two, 79 Chapel St., Hartford, Conn.
Also Mfrs. of Precision Coil Bobbins

LOOKING at TUBES

By **WILFRID B. WHALLEY**

Adjunct Professor of Electrical Engineering
Brooklyn Polytechnic Institute

Brief history of the orthicon television pickup tube.

LAST month the design and operating characteristics of the remarkable tube development—the *iconoscope*—were discussed. This first practical television pickup device is still in active use, particularly for present-day moving picture film reproduction. While it has good resolution and is relatively simple in design, its bad qualities of “shading” and low sensitivity have led to intensive research and development. From this research have come various types of pickup tubes having very high sensitivity and quite uniform brightness level.

The iconoscope showed that high velocity electron beams gave copious secondary electron emission from the mosaic which reduced the sensitivity and also superimposed false signals. Two basic approaches were made to solve these problems. The first was to employ an auxiliary photocathode which led to the *image iconoscope* (known in Europe as the *super emiscope*); the second approach was to employ a beam of low velocity electrons for scanning, which prevented secondary electrons from being produced. After intensive development, this latter method led to the *orthicon* and later to the *image orthicon*.

Low Velocity Scanning

Low velocity electron beam pickup tubes have become so satisfactory and are now used so extensively that it is of real interest to review the prior research work.

The first problem encountered with low velocity electron operation con-

cerned the beam diameter. With the usual type of electrostatically focused gun, the diameter was so large that the resolution was unsatisfactory. Hence, new guns and methods of using them had to be designed.

In addition to the problem of keeping a low voltage electron beam in focus, it was found that the electron must arrive at the mosaic as nearly perpendicular to the surface as possible. If arrival were at an oblique angle (which could readily occur under simple operating conditions due to small electric fields at the surface of the mosaic), then the oblique beam would simultaneously influence several elementary areas of the mosaic and produce a radical drop in resolution. So that there would be some possibility of the electron beam arriving perpendicular to the surface, a new photoelectron emitter had to be developed whereby the image of the scene could be focused on one surface and the scanning by the electron beam could take place on the opposite surface. This differs from the *iconoscope*, where both the image of the scene and the scanning take place on the same surface, requiring the high velocity electron beam to scan obliquely.

Several new types of mosaics and photoelectron emitting surfaces were devised. One type, which can be called the translucent target mosaic, was constructed in the following manner. The caesium silver particles were produced on one surface of a thin glass or mica sheet, while the signal plate (which in the iconoscope mosaic is opaque) was

made transparent. Condensation of metallic vapor was controlled to a density which would still allow a large percentage of light to pass through.

Other types included “two-sided mosaics” and translucent photocathodes. By suitably combining these various photocathodes and mosaics in evacuated envelopes, it was then possible to determine the operating characteristics of low velocity electron beam scanning, without the need of an electron gun.

Experimental Methods

Figure 2 shows the arrangement of one of these experimental tubes. This tube contained a standard mosaic (similar to that used in the iconoscope), shown with the lead going to the video amplifier, and a photocathode having a conducting photosensitive surface. This photocathode was placed perpendicular to the surface of the mosaic, and both were immersed in the d.c. field of an electromagnet. The two pole pieces of the electromagnet were at right angles so that the flux paths fell, as accurately as possible, on sectors of circles of increasing radius.

A novel arrangement was the use of an external cathode-ray tube to provide the means for electron scanning in the pickup tube. The scanning raster on the face of the cathode-ray tube was optically focused onto the photocathode, which then emitted low velocity photoelectrons. Since the flying spot scanner operated at high voltage, the focused light beam diameter was reasonably small; and the groups of photoelectrons, emitted line by line during the scanning, were of correspondingly small diameter. The gun of the cathode-ray tube was supplied with blanking pulses so that the light beam was cut off during the retrace time, thereby avoiding another source of spurious signals.

The d.c. magnetic field was essential both to keep the emitted electrons in focus as they moved toward the mosaic, and to cause them to arrive perpendicular to the mosaic surface. As the electrons entered on a path parallel to the magnetic field, they were constrained to follow the magnetic lines.

Fig. 1. (A) Pickup tube using secondary emission amplification. (B) Schematic diagram of an orthicon.

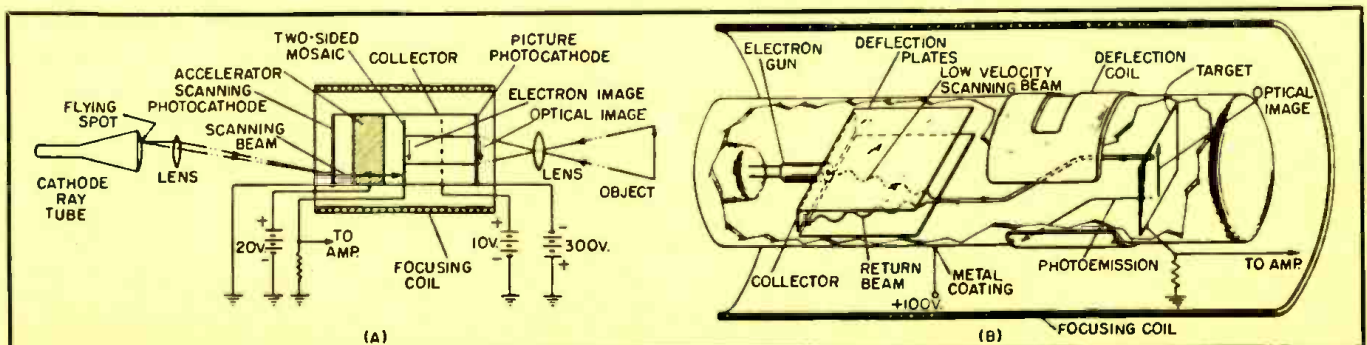

Since these electrons were of low velocity (characteristic of photoelectron emission), no secondary electrons were produced at the mosaic surface. The device provided a picture signal with a steady background and a resolution determined chiefly by the diameter of the light beam from the auxiliary cathode-ray tube.

On each portion of the mosaic where the incident light was zero (dark area of the scene), the silver particles would move to an equilibrium potential such that arriving electrons from the scanning photocathode would be turned back and no signal current would flow to the amplifier. Conversely, on each portion that was illuminated by the scene, the potential would shift during the frame period to a more positive potential, due to the loss of photoelectrons. This small positive potential was then neutralized by the scanning photoelectrons, and it produced an output signal proportional to the light intensity.

Figure 1A shows another experimental low velocity scanning tube. This also employed an auxiliary flying spot light beam, but the internal structure was more complex. It made use of a translucent photocathode at the right, on which the image of the scene was focused, a two-sided mosaic near the center which was connected to the video preamplifier, and another translucent photocathode at the left.

The whole structure was placed inside a long "focusing" coil which produced a d.c. magnetic field parallel to the axis of the tube, as compared to the curved field of Fig. 2. The light beam caused photoelectrons to enter the accelerator field moving toward the mosaic. Photoelectrons proportional to the light intensity were also emitted from the picture photocathode, and these were accelerated toward the other side of the mosaic. The secondary electron emission multiplication produced by the accelerated photoelectrons provided a larger signal from this device than that of Fig. 2.

These experimental devices showed the real advantages of low velocity

Fig. 2. Pickup tube using photoelectrons.

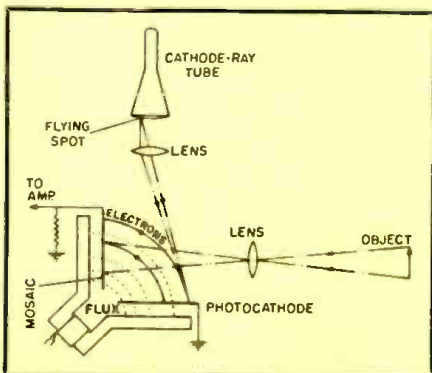

scanning but, needless to say, due to the external cathode-ray tube, they were not practical studio devices.

The Orthicon

The axial magnetic field produced by the large focusing coil was essential to low velocity electron operation, yet the scanning field had to be produced at right angles to the axis. A study of electron paths through a combination axial and perpendicular magnetic field showed that the electrons only diverged from the axis while in the perpendicular field. Hence, the aperture of the scanning field had to be at least as large as the mosaic.

A tube incorporating these principles is shown in Fig. 1B. It will be seen that the whole tube structure from the electron gun to the target was enclosed by the focusing coil. As the electrons left the gun through a limiting aperture of small diameter, they entered a pair of deflection plates. In these combined axial magnetic and electric fields, the electrons followed a cycloidal path toward either the left or right, depending upon the time in the horizontal scan cycle. Leaving the deflection plates, the electrons again moved parallel to the axis until influenced by the perpendicular magnetic field of the vertical deflection coil. After leaving the deflection coil, they again moved parallel to the axis toward the mosaic, and were collected in proportion to the potential of each part of the surface (as determined by the degree of illumination). Electrons which were not collected at the target returned on a path to the deflection plates which was almost identical to their forward path, and then moved on toward the collector.

In practical use, the focusing coil was mounted so that it could be accurately adjusted for alignment with the axis of the gun. The tube was carefully shielded. Otherwise, even relatively weak external fields would have been able to cause motion of the d.c. axial field and distort or reduce the resolution of the picture signal. Blanking pulses were supplied to the electron gun to prevent retrace "smearing."

This pickup tube, which was named the *orthicon*, had the good operating characteristics of the earlier experimental devices of Fig. 1A and 2, but had a larger output signal as well, due to the greater scanning current obtainable from the electron gun. The designation "orthicon" was chosen because a plot of output signal current over a useful range of input light intensity is a straight line. ("Orth," in Greek, means straight). It produced output signals almost completely free from the "shading" present in an iconoscope, had higher efficiency and a resolution of better than 400 lines.

WHEN YOU ORDER

WELLS

COMPONENTS...

HERE'S WHAT YOU GET

- ☐ IMMEDIATE DELIVERY FROM STOCK (in any quantity)
- ☐ FINEST QUALITY OF FAMOUS BRANDS
- ☐ GENERALLY LOWER PRICES
- ☐ RETURN PRIVILEGE FOR FULL CREDIT IF NOT SUITED TO YOUR REQUIREMENTS

The valuable service Wells provides to the industry is being used by many of our greatest manufacturers as a matter of course.

Our vast stock (the world's largest) may contain just the components you need to fill urgent orders — at a substantial savings in time and cost.

ADEL CLAMPS • ANTENNAS, Insulators, Mast Sections • BINDING POSTS • BLOWERS • CABLE ASSEMBLIES • CHOKES • COILS • CONDENSERS Oil Filled, Bathub, Hearing Aid, Transmitting Mic, Silver Mic, Ceramic, Variable, Trimmer • CRYSTALS • FILTERS • FUSES & MOUNTINGS • GENERATORS • GROUND RODS • HEADSETS • I.F. COILS • JACKS • JACK BOXES • KEYS, Telegraph KNOBS • LAMPS • LORD MOUNTS • LUGS MOTORS & BRUSHES • PLUGS • RECTIFIERS Selenium, Copper Oxide, Meter, Diode • RESISTORS—All Types • SELSYNS • SOCKETS • SWITCHES Aircraft, Micro, Switchettes, Toggle • TIMERS • TUBING—Flexible • TUNING SHAFTS • TRANSFORMERS All Types • VIBRATORS • WALKIE TALKIES

DYNAMOTORS

OVER 100,000 NEW DYNAMOTORS IN STOCK!

DM 32A — DM 53A — PE 86 — PE 101C
DM 33A — D 101 — PE 94, etc.

Large quantities of brushes for all types of dynamotors and meters.

Write us for quotations. Advise us your requirements.

A complete Signal Corps stock number listing of items in our stock. Write for listing No. 5G-200. (For government agencies and contractors only.)

Manufacturers and distributors—write for new Condenser Catalog C-10 now available.

Write, Wire, Phone Your Requirements
all phones: **SEEley 8-4143**

WELLS SALES, INC.

833 W. CHICAGO AVE., DEPT. R., CHICAGO 22, ILL.

NEW PRODUCTS

U.H.F. GENERATOR

Having a frequency range of 300 to 1000 mc., the Model 84-TV standard signal generator is useful for determining the characteristics of television receivers for the u.h.f. band and other equipment operating within that range.



It was developed by the *Measurements Corporation*, Boonton, N. J.

The output voltage of the Model 84-TV is continuously variable from 0.1 microvolt to 1 volt across a 50-ohm load. Output impedance is 50 ohms and the VSWR is 1.3 to 1 or better. The filament of the oscillator tube is operated from an external d.c. supply in order to remove residual hum.

Modulation, continuously variable from 0 to 30%, may be obtained from an internal 400-cycle oscillator. Provision has also been made for applying external modulation within the range of 50 to 20,000 cycles. Percentage modulation is indicated by a panel meter.

MECHANICAL FILTER

Far more rigid control of transmitter sideband radiation as well as rejection of adjacent channel interference in receivers is claimed possible with the *Collins* mechanical filter. This unit is

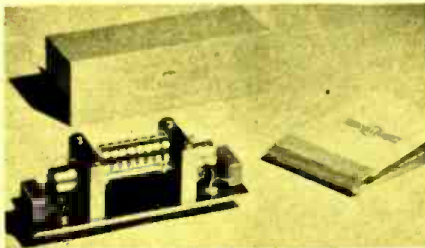

being offered to the electronics industry on a component basis and in addition is being incorporated by the *Collins Radio Company* in new transmitter and receiver designs.

The filter is a magnetostrictively driven unit for intermediate frequency application. Its unusual selectivity and its miniature size make it readily applicable to both military and commercial designs. The entire unit is housed in a hermetically sealed case smaller in size than a normal i.f. transformer.

More detailed information is available on request from the *Collins Radio Company*, Cedar Rapids, Iowa.

DIRECTIONAL COUPLERS

Wideband directional couplers, widely applicable tools for measuring numerous parameters relating to transmission lines, have been announced by *Sierra Electronic Corporation*, 813 Brittan Avenue, San Carlos, Calif. By the use of these couplers, with suitable addi-

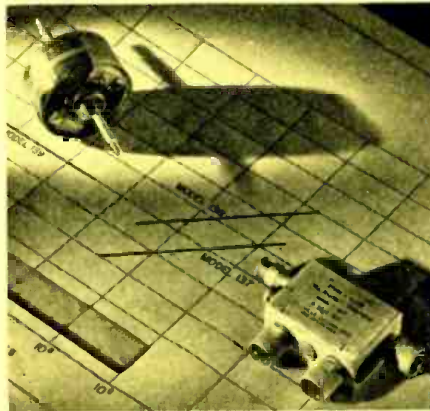

tional instrumentation, reflection coefficient can be determined directly, thus permitting the simplification of several important transmission line measurements.

The *Sierra* couplers are available in three models, 137 and 138 for the frequency range of 30 to 1500 mc., and 139 for the frequency range of 10 kc. to 1 mc. Operating characteristics are shown in the accompanying illustration.

ACCELEROMETER

For measurement of high frequency shock and vibration, the *Endevco Corporation* has made available a "thimble-size" accelerometer of little weight and large output, designed in three models. The small size and weight permits testing of small components under actual or simulated shock and vibration conditions, while the small size and large

output is well suited for missile, aircraft and vibration table measurements.

This instrument gives a self-generated output of 5 millivolts per G. Output is flat ($\pm 5\%$) over the range from 5 cps to 5000 cps, and is stable to within 5% over a temperature range of -20°C to $+70^{\circ}\text{C}$. Model 2201 is a gen-



eral-purpose, stainless steel version with a weight of 0.5 ounces and an output of 5 millivolts per G; Model 2202 is a special, lightweight unit weighing 0.3 ounces; and Model 2203 is a large output unit generating 10 millivolts per G. Additional information may be obtained from *Endevco Corporation*, 180 E. California Street, Pasadena 1, Calif.

RANGE, RANGE-RATE CALIBRATOR

The Model 312 range, range-rate calibrator provides a simulated target for checking the range and range-rate of radar gun laying or ranging systems accurately and rapidly. Recently announced by *Missouri Research Laboratories, Inc.*, 2109 Locust Street, St. Louis, Mo., it may be used in the laboratory or on the production line.

Operating from an external or internal trigger, this instrument will check or calibrate range with an accuracy of .25% from 0 to 50,000 yards (in steps of 0-500, 0-5000, 0-50,000) and range-rate either in or out from 0 to 1500 knots with an accuracy of .5%. Although the Model 312 was designed for



60-cycle operation, 400-cycle models are available, and the company indicates that it can supply any combination of range and range-rate on request.

R.F. GENERATOR

Westinghouse Electric Corporation's new 25-kv. r.f. generator is available in both standard and de luxe models. The standard model is for use on relatively long production runs where readjust-

ment is infrequent; taps on the plate transformer provide power output control. The de luxe model uses saturable reactors to provide reliable stepless power control, thereby facilitating the quick setup changes required on short production runs of a variety of jobs. An electronic keying circuit is also included on the de luxe model to permit rapid and precise control of heat cycles.

The unit is rated at 25 kw. continuous at 450 kc. in accordance with NEMA standards, and the tank circuit has a high kva. rating. Both models have components arranged for easy access in inspection and maintenance. For further information, write *Westinghouse Electric Corporation*, Box 2099, Pittsburgh 30, Pa.

FREQUENCY CALIBRATOR

Measurement Engineering Limited, Arnprior, Ontario, has announced the availability of their Model CFR-1 frequency calibrator. A portable, self-contained secondary frequency standard, it provides accurate frequencies in the



range of 10 kc. to 500 mc., with a stability of 1 part per million.

Model CFR-1 is designed for laboratory or production checking and calibration of r.f. signal generators, receivers, wavemeters and frequency meters, in addition to many other applications requiring a source of accurate frequencies. Electrical features include: five fundamental frequencies with their associated harmonics, individual crystal controlled oscillators, an internal aperiodic detector, modulation level control, and an electronically regulated power supply. Output frequency may be modulated by an internal 400-cps signal.

TV CAMERA FOR INDUSTRY

Production of a highly portable, self-contained TV camera, having all adjustments on the unit itself, has been announced by the *Dage Electronics Corporation*. Of "briefcase" size, the camera is tailored specifically to the visual requirements of business and industry.

The Dage unit features a simplified circuit that requires a minimum of attention and maintenance. It is no harder to focus than any home receiver. For remote viewing, any standard television receiver can be connected to it

by means of a single inexpensive coaxial cable. A single camera can be hooked up with one or more TV receivers or, conversely, a number of cameras set at different locations can televise to one or more receivers.

For more information, write to the *Dage Electronics Corporation*, 69 North 2nd Street, Beech Grove, Indiana.

DIGITAL RECORDER

Now available from the *Berkeley Scientific Division of Beckman Instruments, Inc.*, is the Series 1550 digital recorder—a printed readout for high-

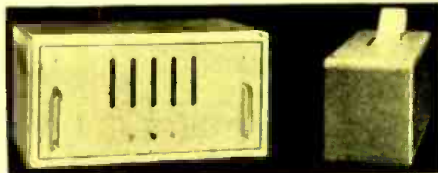

speed electronic counters. Composed of a readout unit and a printing recorder, the instrument provides a direct means of permanently recording sequential count information in Arabic numeral form on standard adding machine tape.

This digital recorder is designed to operate from electronic counters, time interval meters, events-per-unit-time meters, nuclear scalars, or other electronic totalizing devices at a maximum cycling rate of one printout every .8 second. Recording and indicating capacity is 3, 4, 5 or 6 decades. Most standard *Berkeley* instruments now in use can be readily adapted for operation with this unit.

ILLUMINATED PANEL METER

The difficult problem of illuminating miniature meters has been overcome by *International Instruments, Inc.*, in their new 1½" panel meter. A compact D'Arsonval movement permits light to go through a sealed "peep" window in the rear of the instrument case, pass over the movement and be diffused through a translucent plastic scale. The source of illumination is a miniature aircraft lamp, mounted in a specifically

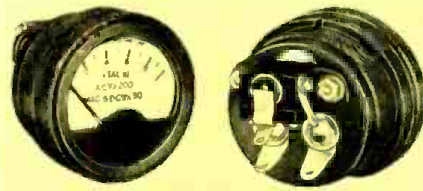

designed housing attached to the back of the case.

Available in two styles — Model 150 (round case) and Model 153 (square case), the single unit assembly is said to make installation fast and easy. The

(Continued on page 31)

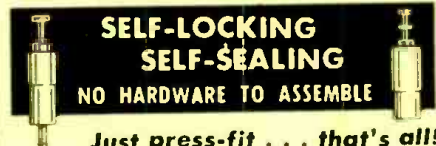

**SELF-LOCKING
SELF-SEALING
NO HARDWARE TO ASSEMBLE**

Just press-fit . . . that's all!

NEW—

Sealectro miniature

STAND-OFF and FEED-THRU

TEFLON* INSULATORS

for High Frequencies up to . . . and even beyond. Sealectro Miniature Teflon* Insulators, newest advance in electronics insulation, outperform all commercial ceramic and plastic insulators in electrical and mechanical properties—and permit great assembly economies and easy miniaturization.

they install in seconds!



Drill hole diameter .005" smaller than body diameter of insulator. Press-fit insulator into hole with Press-Fit Hand Tool . . . that's all! Inexpensive Press-Fit Hand Tools are available in 3 sizes to fit every type of Sealectro Insulator.

mechanical features

- **Assembly time and costs slashed:** Sealectro's new design, toughness and compressibility permit installation by high-speed economical assembly techniques—never before possible with ceramic stand-off and feed-thru insulators.
- **Require minimum space:** enables miniaturization
- **No breakage in transit or assembly**
- **Shock-proof and vibration-proof**

electrical properties

OF SEALECTRO Miniature Teflon* INSULATORS

Dielectric strength, short-time, 0.080 in. (D149-44) 400-500 v/mil*
 Volume resistivity (D257-45) >10¹⁵
 Surface resistivity, 100% R.H. (D257-45) 3.6 x 10⁸
 Dielectric constant, 60 cycles (D150-45T) 2.0
 Dielectric constant, 10⁸ cycles (D150-45T) 2.0
 Power factor, 60 cycles (D150-45T) <0.0005
 Power factor, 10⁸ cycles (D150-45T) <0.0005
 Temperature stability of dielectric properties excellent
 *Value is 1000-2000 volts/mil in thicknesses of 5 to 12 mils.

other properties

OF SEALECTRO TEFLON* INSULATORS

Tensile strength, 77 F. (D638-44T) 1500-2500 lb./sq. in.
 Elongation, 77 F. (D638-44T) 100-200%
 Stiffness, 77 F. (D790-44T) 60,000 lb./sq. in.
 Impact strength, Izod 70 F.
 (D256-41T) 2.0 ft.-lb./in.
 Impact strength, Izod 77 F.
 (D256-41T) 4.0 ft.-lb./in.
 Maximum service temperature* 500 F.
 Water-absorption (D570-42) 1-2.3
 Specific gravity (D792-44T) nonflammable
 Flammability (D635-44) excellent**
 Resistance to weathering 0.0
 **Teflon* has been used successfully in many cases at higher temperatures. This is a conservative general-purpose upper limit.
 *No detectable change after 5 years of outdoor exposure in Florida.

SEALECTRO Teflon* Insulators are available in 6 Stand-Off and 5 Feed-Thru models—and in sizes to specification. These insulators are products of Sealectro Corporation and are nationally merchandised by Grayburne Corporation. Grayburne carries a complete stock of these insulators for immediate delivery.

Write for latest Catalog ZE-1 and price schedule.

*Teflon is a registered trade-mark of E. I. duPont de Nemours & Co.



103 Lafayette Street, New York 13, N. Y.

NEW LITERATURE

PREDETERMINED COUNTERS

Of special interest to production men are the new "SP" small, predetermined productimeters, designed for both stroke and rotary application, which can control production to the exact quantities required and eliminate losses due to overruns and underruns. Complete description, specifications, dimensional data, and switch capacities are contained in Bulletin No. 501, available on request from the *Durant Manufacturing Company*, 1919 North Buffum Street, Milwaukee 1, Wis.

COPPER-OXIDE RECTIFIERS

Basic characteristics and applications of copper-oxide rectifier stacks are described in an eight-page, two-color booklet which is being offered by the *General Electric Company*, Schenectady, 5, N. Y. Designated as GEA-5699A, the booklet is complete with charts, graphs, and tables illustrating the characteristics, manufacture, circuit design, and application of *G-E* copper-oxide rectifiers.

ELECTRICAL LAMINATIONS

T & S electrical laminations—the special "OrthoSil" oriented steel used in their manufacture—are cov-

ered in Bulletin L-752, now being offered by *Thomas & Skinner Steel Products Company*. Materials, specifications, and test results are described, accompanied by actual size drawings of special and standard shapes, specification tables and graphs.

For your copy of Bulletin No. L-752, write to *Thomas & Skinner Steel Products Co.*, 1124 East 23rd Street, Indianapolis, Ind.

LACQUER AND CEMENT

Some of the important properties of "Q-Max" A-27 lacquer and "Q-Max" A-27 cement for radio and electronic service are discussed in detail in Bulletin 752, copies of which may be secured on request from *Communication Products Company, Inc.*, Marlboro, N. J. Tables on various test data are included, as well as diagrams giving power factor, loss factor and dielectric constant values.

DIRECT-WRITING RECORDERS

The advantages of using *Sanborn* equipment for the study and recording of a wide variety of electrical and mechanical phenomena are explained in a 16-page bulletin which has just been released. Entitled "7 Advantages of *Sanborn* Direct-Writing Recorders

for Industrial Users," this bulletin may be obtained without obligation by writing to the *Sanborn Company*, 38 Osborne St., Cambridge, Mass.

RADIO TELEMETERING

A four-page brochure presenting airborne and ground station equipment and accessories for radio telemetering is now available. Copies may be had by writing to *Applied Science Corporation of Princeton*, P. O. Box 44, Princeton, N. J.

Charts show building block accessories in complete PW or PDM systems and custom-engineered ground station and laboratory equipment for the reception, recording, calibration, linearization, plotting and tabulation of data from airborne systems. The ASCOP fully automatic data treating device for reading and processing telemetering data is also covered.

CIRCUIT BREAKERS

"What You Should Know About Circuit Breakers" explains the operating principles of basic circuit breaker designs and provides engineering data on factors of application. This manual, which has just been published by the *Heinemann Electric Company*, also includes simplified diagrams showing the three basic types of circuit breakers in general use today with a brief description of each.

Copies of Manual 101 are available upon request from the *Heinemann Electric Co.*, 502 Plum Street, Trenton 2, N. J.

PRECISION RESISTANCE INSTRUMENTS

The complete line of precision electrical resistance instruments and electronic devices manufactured by *Tech Laboratories, Inc.*, is described in a 38-page catalog which has recently been released. Among the instruments covered are various attenuators and potentiometers, meter multipliers, matching networks, decade units, microhmmeters, tap switches, and many others.

Copies of this bulletin may be obtained by writing to *Tech Laboratories, Inc.*, 14E Edsall Boulevard, Palisades Park, N. J.

CHOPPERS

Catalog 280B, available from *Stevens-Arnold Inc.*, 22 Elkins Street, South Boston 27, Mass., describes the 1953 models of the *Stevens-Arnold* d.c.-a.c. choppers. These choppers are electromechanical precision vibrators, designed with emphasis on long life and low noise level. Having a frequency range of 10–500 cps, they are used as modulators or demodulators.

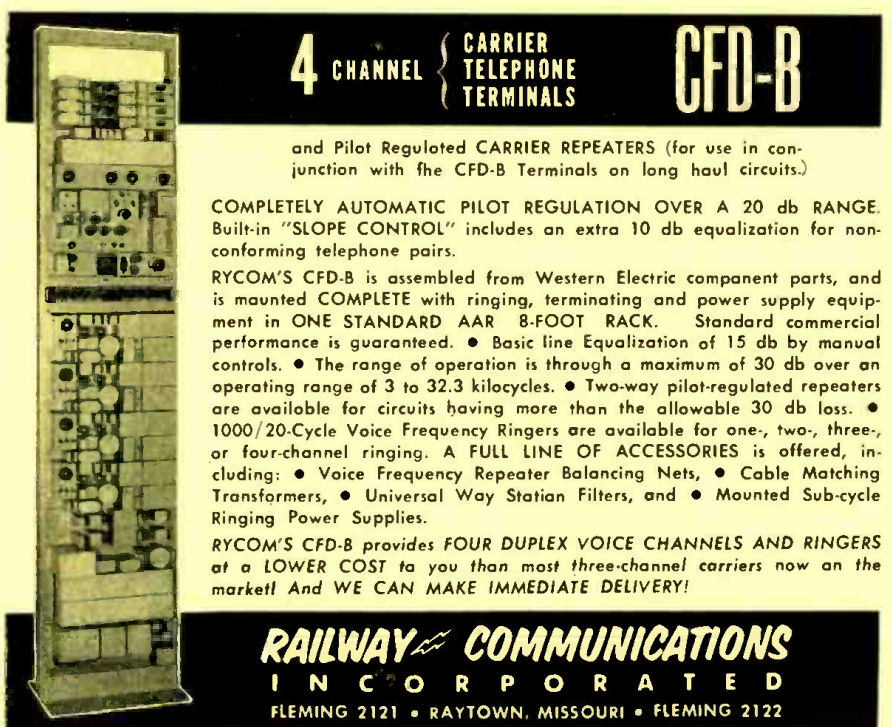

and Pilot Regulated CARRIER REPEATERS (for use in conjunction with the CFD-B Terminals on long haul circuits.)

COMPLETELY AUTOMATIC PILOT REGULATION OVER A 20 db RANGE. Built-in "SLOPE CONTROL" includes an extra 10 db equalization for non-conforming telephone pairs.

RYCOM'S CFD-B is assembled from Western Electric component parts, and is mounted COMPLETE with ringing, terminating and power supply equipment in ONE STANDARD AAR 8-FOOT RACK. Standard commercial performance is guaranteed. • Basic line Equalization of 15 db by manual controls. • The range of operation is through a maximum of 30 db over an operating range of 3 to 32.3 kilocycles. • Two-way pilot-regulated repeaters are available for circuits having more than the allowable 30 db loss. • 1000/20-Cycle Voice Frequency Ringers are available for one-, two-, three-, or four-channel ringing. A FULL LINE OF ACCESSORIES is offered, including: • Voice Frequency Repeater Balancing Nets, • Cable Matching Transformers, • Universal Way Station Filters, and • Mounted Sub-cycle Ringing Power Supplies.

RYCOM'S CFD-B provides FOUR DUPLEX VOICE CHANNELS AND RINGERS at a LOWER COST to you than most three-channel carriers now on the market! And WE CAN MAKE IMMEDIATE DELIVERY!

RAILWAY COMMUNICATIONS
INCORPORATED
FLEMING 2121 • RAYTOWN, MISSOURI • FLEMING 2122

TECHNICAL BOOKS

"PRINCIPLES OF RADAR," Third Edition, edited by J. Francis Reintjes and Godfrey T. Coate. Published by McGraw-Hill Book Company, Inc., 330 West 42nd Street, New York 36, N. Y. 985 pages. \$7.75.

As before, the third edition of "Principles of Radar," compiled by members of the staff of the M.I.T. radar school, deals with the basic concepts and techniques of radar. It presents the engineering principles of the pulse circuits and the high frequency devices common to nearly all radar systems.

In this latest edition, the order of presentation has been completely reorganized, and virtually all of the material has been rewritten. The subject matter has been expanded by approximately 20 per cent, and more than half of the illustrations are new. A chapter on r.f. transmitting and receiving systems has been added.

The book begins with a description of the general features of radar systems and system components. This material

is followed by detailed discussions of pulse circuits and their application to radar modulators, indicators, and receivers. The latter part of the book is devoted to the r.f. aspects of radar; it covers basic concepts pertaining to transmission lines, wave guides, cavity resonators, and antennas, together with the techniques of their use.

"FUNDAMENTALS OF ENGINEERING ELECTRONICS" by William G. Dow, Professor of Electrical Engineering, University of Michigan. Second Edition. Published by John Wiley & Sons, Inc., 440 Fourth Avenue, New York 16, N. Y. 627 pages. \$8.50.

The most important broad objective of this book is to make it relatively easy to achieve a reasonably complete and satisfactory understanding of the internal functioning of the electron devices that serve as the active elements in electronic circuits. Professor Dow has arranged and described the fundamentals of charged-particle behavior in such a way as to appeal to the engineer's analytical approach. Principles of particular importance to the engineer are selected for study; illustrations of these principles are drawn from engineering practice; and physical concepts

are so treated as to permit ready determinations of magnitudes.

Among the changes which highlight the second edition are: the MKS system of units is employed throughout; the analysis of the behavior of space-charge-control tubes has been modernized by the introduction of equivalent electrostatic circuit and equivalent grid sheet potential concepts; basic new principles that must be employed in electron tubes designed for use in the u.h.f. and microwave frequency ranges are presented; and the basic aspects of semiconductor energy-level diagrams and their general relation to the behavior of transistors are discussed with reference to the Fermi distribution function and the Fermi energy-level.

TRANSMISSION LINE IMPEDANCE MEASUREMENT

By GERALD W. LEE

WHEN SETTING up a new broadcasting station, the radio engineer is always faced with the necessity of knowing accurately the characteristic impedances of the transmission lines. The following method of determining line impedance is comparatively recent and is not given in detail in any of the various textbooks on broadcast engineering.

The equipment needed is an r.f. signal generator, an r.f. bridge, a detector, and an accurate 0—1000 ohm decade resistance box or a variety of calibrated resistances of values near the theoretical impedance of the line. A decade box is more satisfactory as it is usually calibrated in steps of one-tenth ohm, and therefore the characteristic impedance can be measured to that accuracy.

1. Connect one end of the transmission line through the resistance box to ground. The ground connection may be made to the line ground; and the box should be set at the theoretical line impedance.
2. Set the r.f. signal generator for the frequency at which the station will operate, and to it connect the r.f. bridge and detector in the usual manner for measuring impedance, as shown in the block diagram.
3. "Look into" the line with the impedance measuring gear at the end opposite to that at which the decade resistance box is connected.
4. Vary the decade resistance box until the resistance measured by the r.f. bridge equals the resistance of the box. This resistance is then the characteristic impedance of the transmission line.

A brief discussion of the theory involved in measuring by this method may be in order. Terman states: "In non-resonant lines the terminating impedance Z_L at the end to which the line delivers the power is made equal to the characteristic impedance. There is then only the incident wave train present and the power is transmitted at unity power factor. The power loss and peak voltage to which the line is subjected are then less than with any other mode of operation."

The above is essentially what has been done here, that is, the load impedance has been made equal to the characteristic impedance so that it is possible to look into the line and see its characteristic impedance.

In conclusion, it is the opinion of the author, which has been verified many times in the field, that the above procedure is easily the most accurate and time-saving method yet devised of measuring line impedance.

Block diagram of method employed.

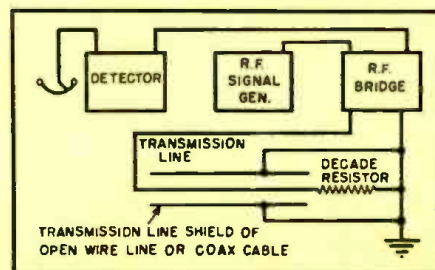

Why use
Microwaves?

Read
Essentials of
**MICRO-
WAVES**

By ROBERT B. MUCHMORE,
Hughes Aircraft Co.

A new book presenting in basic terms—without mathematics—the physical principles and applications of microwaves. Covers wave propagation and reflection, cavity resonators and filters, microwave antennas, electronic devices, noise, microwave radio systems and relays, radar, and microwave measurements.

1952 236 pages \$4.50

Write for copy on 10-day approval

JOHN WILEY & SONS, INC.

440 4th Ave., New York 16, N. Y.

Electronics Engineer

Group leader required to take charge of an electronics laboratory engaged in analytical instrument development. Design ability in conventional circuitry as applied to a.c. and d.c. amplifiers, power supplies, light detection devices, thyatron circuits, discriminators, magnetic circuitry and fractional horse-power motors desirable.

Five years experience or advanced degrees in lieu of part of this experience required. This position is a permanent one with an old established instrument company who is a leader in the field.

Send résumé with salary requirements to:
Personnel Manager

Fisher Scientific Company

717 Forbes St.

Pittsburgh 19, Pa.

Personals

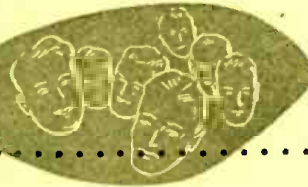

WILLIAM W. DEAN is now the director of engineering of the *Langevin Manufacturing Corporation*, New York, N. Y. He was associated with *General Electric Company* for 11 years prior to joining the *Langevin* organization; since 1945 he has been audio facilities project engineer in *G-E's* broadcast engineering section at Electronics Park. A senior member of the IRE, Mr. Dean is the author of a number of technical papers on broadcast audio facilities.



DONALD N. KIRKPATRICK has been appointed chief engineer of the *National Company, Inc.*, Malden and Melrose, Mass., in which position he will be responsible for all engineering activities including the development of new products. Mr. Kirkpatrick graduated from Lafayette College in 1932. Prior to his most recent employment as chief engineer of the *Boonton Radio Corporation*, he had already had 13 years of experience in the electronics industry.



JOHN K. McDONOUGH was promoted from general sales manager to general manager of the Radio & Television Division of *Sylvania Electric Products Inc.*, Buffalo, N. Y. Mr. McDonough joined *Colonial Radio Corporation*, predecessor company of the division, in 1943, and served as assistant to the vice president in charge of operations before becoming sales director in 1949. When *Colonial* became a division of *Sylvania*, he was appointed sales manager.



DR. CARL F. MOEN has joined the research and engineering team of *Electro-Voice, Inc.*, Buchanan, Mich., electro-acoustic and electronic manufacturers, as senior engineer. Formerly a professor of physics at Pennsylvania State College, Dr. Moen received his Ph.D. degree in physics from the University of Toronto. During World War II, he conducted research on the theory of liquids and underwater sound for the Royal Canadian Navy.



DR. DAVID B. PARKINSON, who joined the *Brush Development Company*, Cleveland, Ohio, as department head of product engineering in 1948, has now been named production engineering manager. From 1938 to 1948, Dr. Parkinson served with *Bell Telephone Laboratories*, developing telephone equipment and systems, and anti-aircraft and other gun directors. For his work on the latter, he was awarded the Presidential "Medal for Merit" in 1947.



EDWIN J. RUDISUHLE, formerly with the Civil Aeronautics Administration as chief, electronics establishment branch, ninth region, has now joined the sales engineering department of *Lenkurt Electric Co.*, San Carlos, Calif. He will be concerned primarily with the application of carrier channelizing equipment to v.h.f. and microwave radio links. Mr. Rudisuhle's previous experience includes several years with the FCC as field and laboratory engineer.

D.C. Amplifier

(Continued from page 9)

be adjusted with a screwdriver until the meter reads zero. If the needle swings to the left, the meter leads should be reversed. The switch must then be returned to position 2 or zero position and a small source of potential inserted in the input circuit. A 1½-volt battery across a 10,000-ohm potentiometer will serve adequately. A d.p.d.t. switch across the output will be required to reverse the polarity. Starting at zero volts, the potentiometer setting should be advanced slightly so that the needle will deflect to about 0.8 ma. when the instrument switch is at position 3.

Then, the switch should be returned to position 2 and the polarity of the input voltage changed without changing its value. To accomplish this, the small d.p.d.t. switch is used in series with the low voltage from the battery circuit. The switch is now rotated clockwise to position 4 to check deflection on the reversed polarity. Deflection should be the same—0.8 ma. If it is not, the plate balance adjust *R*₁ must be rotated slightly and the new meter reading checked against that of position 3 after input polarity is reversed. When the needle is deflected to the same meter reading by the same input potential on position 3 and position 4 by reversing the polarity of the input voltage but not its value, the plate balance will be correctly adjusted.

When use of the instrument as a millivoltmeter is desired, a laboratory potentiometer is placed across the input and set for 250 mv. Then the switch is turned to "position 2 adjust." The "position 2 adjust" should be "zeroed" first. Finally, after the sensitivity control for meter *R*₂ is adjusted so that the needle will give full deflection for 250-mv. input, the meter is ready.

Recorders with 50-mv. full scale traverse require inputs with a reading of 0.20 ma. on this meter which corresponds to 50 mv. Improper polarity is indicated by the meter if the needle swings to the left, off scale. Thus, a total voltage of 0.500 volts can be achieved from ±0.250 volts. Much higher voltages can be measured through the use of input divider resistors.

For pH meter applications, the calibration is identical to that above through the plate balance operation. The glass electrode is inserted in the grid input lead and a calomel electrode is plugged into the pin jack. With the electrodes immersed in a buffer of pH 7, the meter is zeroed in position 2 as before. The switch should now be turned to position 3 and "position 3 adjust" adjusted until the meter reads zero; then the switch should be returned to position 2. Buffer pH 7 should be exchanged for buffer

pH 10.0 and the switch turned back to position 4. Meter sensitivity R_s should be adjusted until the meter reads 0.6 ma. The meter will then be ready for use.

With a glass electrode, the potential varies nearly linearly with the pH change referred to a reference-saturated calomel electrode. Thus, a practical glass electrode, such as a *Beckman*, with a reference pH = 7.00 will show no potential if placed in a solution whose pH is 7.00, but will show a potential if the solution in which the electrode is placed is other than 7.00. The greater the difference between the pH of the glass electrode and the solution in which it is immersed, the greater the voltage that is developed with reference to the calomel electrode. Since pH = 7.00 is accepted as a neutral condition, acid pH's read from 7.00 down, while basic pH's are read from 7.00 up, reversing polarity at 7.00.

The pH = 7.00 corresponds to a zero meter reading and each 0.20-ma. meter reading corresponds to 1 pH unit. So if the reference glass electrode is pH = 7.00, the acid scale will read pH = 7.00 to pH = 2.00 while the base scale will read pH = 7.00 to pH = 12.00. The range can be shifted by using glass electrodes with other reference pH's, and can be set for specific titrations in this manner if so desired. Also, the full 14 pH units can be scaled if proper meter sensitivity adjustment is made. However, a new scale would have to be constructed and the linearity of pH measurements with the glass electrode would tend to fall off at both ends of the scale. The range selected was decided upon as being most practical since it was not necessary to change or deface the scale in any way. The "pH adjust position" or position 3 is used to balance out the small asymmetry potential encountered with glass electrodes.

Conclusion

After initial calibration, the instrument should be aged by turning the switch to position 2 and allowing it to remain on overnight. In the morning, the calibration should be repeated and checked for variation.

For daily use, it is recommended that the instrument be left on all day in position 2. (It has been left on for over 100 hours with no sign of ill effects.) When a reading is to be taken, the switch should be turned to position 3 or position 4, depending upon which polarity prevails, and the reading noted. After the reading is taken, the switch is returned to position 2 until the next reading is taken. The switch should not be returned to position 1 since this would turn off the power for the meter and a warming-up period would then be required before the next reading.

Temperature compensation was not found to be necessary and so was not included as a feature.

This instrument can be used as a sensitive electronic polarized relay by the insertion of a polarized relay in the circuit in place of the meter. Thus, a reversible motor could be actuated by very small out-of-balance voltages

from a preset value at the input of the instrument. In this respect, it could serve as a rough servomechanism to regulate power supply voltages, temperatures, pressures, or pH's.

The applications of this versatile unit are many and the time spent on its construction should be repaid many times in good service.

INSTRUMENTATION FOR COLOR TELEVISION

PRACTICALLY all of the color television art in its present stage of development is encompassed in this giant "package" just completed by *Telechrome, Inc.*, Amityville, L. I., for a west coast client.

The equipment is capable of transmitting and receiving any of the commonly accepted types of color television (wideband simultaneous, NTSC, field sequential, line sequential encoding) as well as generating the necessary auxiliary synchronizing color subcarrier and color information. A programming system, test switching system, preview monitor, a monochrome system, flying-spot scanner for slides and roll-strip films, a color bar and dot synthesizer, necessary tri-color monitoring, transmitting at both r.f. and video, and receiving decoding equipment are also included. The unit is suitable for research or development as well as for on-the-air use. It consists of a compact seven-rack assembly with a built-in motor-driven quick-change arrangement for shifting from one system to another as well as for setting up the monochrome equivalent at both field sequential and RTMA rates.

Rack #1 provides the driving sources for all systems and contains the sync generators as well as the color subcarrier and the interlaced sampling divider.

Next in line is the encoding and matrixing rack which houses gamma amplifiers, keyed clamp and NTSC burst generators, NTSC keyers, and transmitting samplers.

Near the center of the assembly is the control rack, the hub of the setup. Emanating from a 60-button automatic switching panel are the "nerves" which reach to every unit in the assembly. Distribution and programming are done at this rack, permitting observation and

study of practically every point in the over-all system. In this rack, too, are the waveform scope and the NTSC monochrome monitor.

The center rack is for color pickup and scanning. The universal pickup here is equipped with crossed dichroic mirrors: red and blue reflecting, green transmitting; Wratten correcting filters are used in the red and blue channels; vignetting provided by a full scan of the seven-inch tube is held to a minimum. The universal color scanning generator is of the flying-spot type and produces three simultaneous red, green, and blue primary color signals. Resolution is better than 500 lines at standard RTMA rates and better than 400 lines at standard FCC rates.

The universal color monitor which displays the pictures produced at the scanner or bar generator is in rack #5; off-the-air signals are shown here too. The monitor uses three separate red, green, and blue reproducing kinescopes. Crossed dichroic mirrors are used for optical superimposition of the three color images so produced. The color range is superior to the best that can be obtained with present color photography, such as Kodachrome, die-transference or chemical processes. Extra rigid structural metal members maintain the dimensional stability and alignment of this unit.

Rack #6 contains the three color video amplifiers, the off-the-air receiver, and the color bar generator which produces fully saturated color bars for reception in scanning rack and display at the monitor.

The final rack performs several functions: decoding (both NTSC and field sequential), phase-equalization, and modulation-checking of the picture-and-sound transmitter.

Front view of the seven racks comprising the unit.

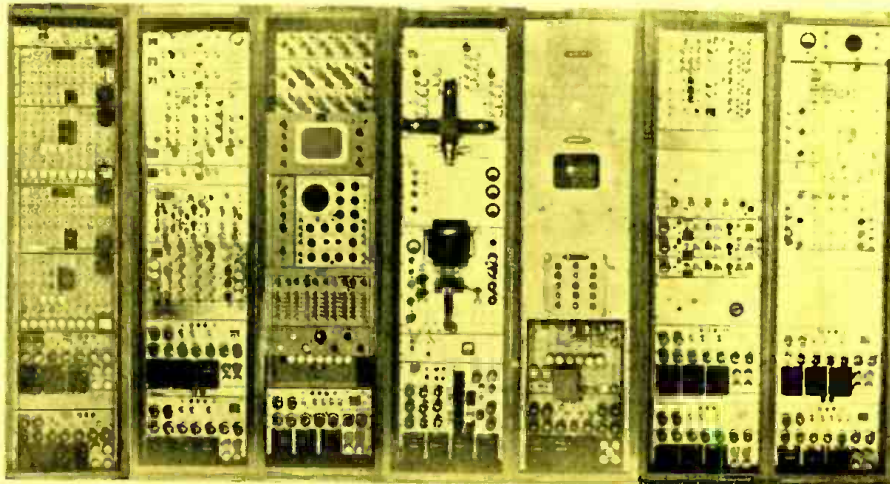

New Products

(Continued from page 25)

lamp is supplied for 6, 14 and 28 volts. For complete details, write to *International Instruments, Inc.*, P. O. Box 2954, New Haven 15, Connecticut.

SCALER-PRINTER

A new scaler-printer, designed for radiation counting as applied in nuclear work, packaging and other applications, has been announced by the Research & Control Instruments Division of the *North American Philips Company, Inc.*, 750 South Fulton Avenue, Mount Vernon, N. Y.

This instrument indicates in printed numerals up to 999 and provides for multiplying this figure by 2, 4, 8, 16, 32 and 64. It will resolve pulses separated by 5 microseconds and will perform reliably for indefinite periods of time. An interval timer having a range up to 55 seconds allows count accumulation for a predetermined interval, reproducible to within 0.13 seconds.

An alternative indicator is available on the scaler chassis in the form of three rows of neon lamps in decimal arrangement. This works independently of the printer and can be relied upon separately.

SIX-CHANNEL AMPLIFIER UNIT

Model 201-A is a portable, self-contained system for the accurate measurement of such physical phenomena as strain, pressure, acceleration, vibratory displacement, and velocity. For detailed specifications and technical or application information, write to the *Yellow Springs Instrument Company, Inc.*, P. O. Box 106, Yellow Springs, Ohio.

This amplifier unit comprises: six individually excited, three-stage, single-channel amplifiers, with output metering and overload indicating circuits and with linear and integrated amplification employed to provide for the use of a wide variety of pickup devices; a separate electronically regulated power supply providing both a.c. and d.c. power to all channels; a shock mounted cabinet with power plugs for inserting

the single-channel amplifier units and the necessary power and test cable assemblies.

RADIATION DETECTOR

Nuclear Instrument & Chemical Corporation, 229 West Erie Street, Chicago 10, Ill., announces the "Isotron"—a console-type instrument which permits clinical use of radioisotopes for both diagnosis and therapy. The Model 1617 Isotron incorporates a count rate indicating circuit, a special regulated high voltage supply, a gamma ray sensitive probe, an arm for positioning the probe, and a chart recorder to provide a continuous automatic record of the counting rates for a permanent record.

Housed in a compact cabinet, the Isotron operates on 120-volt, 60-cycle current. A simple set of controls is mounted on the slanting top panel, which provides for selection of counting ranges, choice of time constants to achieve desired counting accuracy, and variation of high voltage.

SELENIUM RECTIFIER CELL

For applications where size and weight are primary considerations, the *Federal Telephone and Radio Corporation*, Clifton, N. J., has designed a selenium rectifier cell rated at 36 volts (r.m.s.). Because the individual cell is so rated, a rectifier stack made up of these cells will not only withstand a higher reverse voltage, but will require fewer cells for the same voltage output. As a result, losses will be proportionately less, and the efficiency of the stack considerably increased.

The newly developed *Federal* rectifier unit is particularly well adapted for use in aircraft and in many types of military equipment. Its compactness and lighter weight also make it well suited for use in battery chargers and power supplies.

PRECISION RESISTORS

Featured in the Series "E" precision wire-wound resistors manufactured by the *Hycor Company, Inc.*, 11423 Vanowen Street, North Hollywood, Calif., are: noninductive windings on ceramic bobbins; a standard temperature coefficient of 0.00025 per degree C; varnish impregnation for moisture protection; and high resistance plus accuracy in small space.

Series "E" resistors are designed for use in applications requiring accuracy, stability and long life under conditions of extreme temperature variation plus moderately high humidity. They are wound with either Evanohm or Manganin wire, providing very low thermal emf against copper.

Frequency Calibrator

(Continued from page 13)

was considered desirable to provide sufficient gain to drive a small loudspeaker directly, an output from the amplifier of 50 to 100 milliwatts was required. For such an output, a voltage gain of about 5000X is necessary. Although the 6X8 pentode-triode has a common cathode which complicates the bias problem, it was found suitable for this application. Bias was provided by means of a tapped cathode resistor system which was found to work quite well. This biasing system permitted the pentode section to be operated at a suitable bias level and the triode section to be biased so as to develop the desired power output. In this circuit, the audio response is peaked to minimize low frequency microphonics which develop when the small loudspeaker is mounted on the same chassis with the amplifier. The shunt capacitor across the output transformer attenuates the high frequency response in order to reduce the inherent noise which might be objectionable because of the high gain of the pentode section. Values of the coupling capacitors are small so as to reduce the low frequency response of the unit.

Figure 1 is a photograph of the calibrator constructed on a small breadboard-type experimental chassis. This particular unit produced a sensitivity to external signals of 50 millivolts for 100 milliwatts of audio output at 1000 cycles.

CALENDAR of Coming Events

JANUARY 26-30—IAS-IRE-RTCA-ION Symposium on Electronics in Aviation, New York, N. Y.

JANUARY 26-27—Seventh Regional IRE Conference, University of New Mexico, Albuquerque, N. M.

FEBRUARY 4-6—Western Computer Conference, Hotel Statler, Los Angeles, Calif.

FEBRUARY 5-7—IRE Southwestern Conference and Electronics Show, Plaza Hotel, San Antonio, Texas

MARCH 23-26—IRE National Convention, Waldorf-Astoria Hotel and Grand Central Palace, New York, N. Y.

APRIL 11—New England Radio Engineering Meeting, University of Connecticut, Storrs, Conn.

APRIL 18—Spring Technical Conference of the Cincinnati Section, IRE, Engineering Societies Bldg., Cincinnati, Ohio

MAY 11-13—National Conference on Airborne Electronics, Hotel Biltmore, Dayton, Ohio

PHOTO CREDITS

PAGE	CREDIT
3	Bendix-Pacific Corp.
4, 5	Ampex Electric Corp. and Audio & Video Products Co.
6	Fairchild Recording Equip. Corp.
7	Coleman Inst. & Mfg. Co.
10, 11	Nat. Bureau of Standards
12, 13	Radio Corp. of America
14, 15, 16	Press Wireless Mfg. Co.
20, 21	RCA Review

SENDING END IMPEDANCE OF UNIFORM LINE

This chart may be used to obtain input resistance of lossless shorted and open transmission lines.

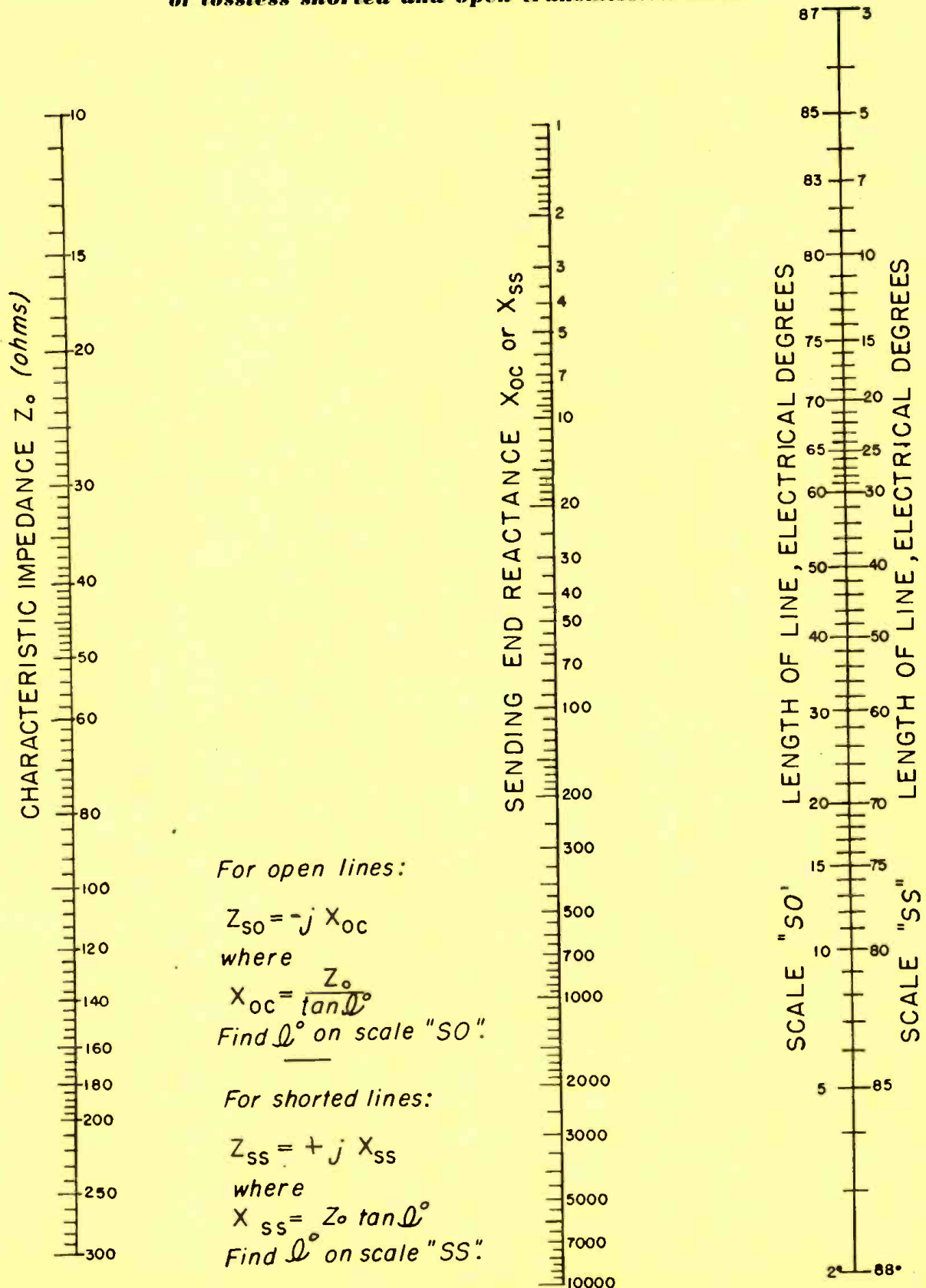

For open lines:

$$Z_{so} = -j X_{oc}$$

where

$$X_{oc} = \frac{Z_0}{\tan \theta^\circ}$$

Find θ° on scale "SO".

For shorted lines:

$$Z_{ss} = +j X_{ss}$$

where

$$X_{ss} = Z_0 \tan \theta^\circ$$

Find θ° on scale "SS".

Courtesy of Federal Telephone and Radio Corporation.

LEARN RADIO



INSIDE OUT!

THAT'S the way to become an expert radio serviceman. Study the theory and principles first. These are vitally important. Then roll up your sleeves and actually work with radios— assembling, experimenting, trouble-shooting, repairing. That way you learn radio from the inside out.

Which explains why I.C.S., in its new Radio Course, concentrates on *equipment*. You get the best. Matched parts for an excellent 5-tube superheterodyne receiver. Your own professional-quality multimeter. A complete signal generator

kit. High-grade servicemen's tools. "Rider's Perpetual Trouble-Shooter's Manual." Plus lesson material and instruction service second to none. Also included is Principles of Television, which is a steppingstone to TV installation and service. And there's a new course in *FM and Television* that includes **COLOR TV!**

Learn by doing! That's the famous I.C.S. method. Practical. Modern. *Success proved.* The coupon below brings you full details—on radio servicing or any of the 391 I.C.S. Courses. Mail it *today!*

INTERNATIONAL CORRESPONDENCE SCHOOLS



BOX 2251, SCRANTON 9, PENNA.

Without cost or obligation, send me "HOW to SUCCEED" and the booklet about the course BEFORE which I have marked X:

- | | | | | |
|---|---|---|---|--|
| <p>ART</p> <ul style="list-style-type: none"> <input type="checkbox"/> Commercial Art <input type="checkbox"/> Magazine and Book Illustrating <input type="checkbox"/> Cartooning <input type="checkbox"/> Show Card and Sign Lettering <input type="checkbox"/> Fashion Illustrating AUTOMOTIVE <input type="checkbox"/> Automobile, Mechanic <input type="checkbox"/> Auto-Elec. Technician <input type="checkbox"/> Auto Body Rebuilding and Refinishing <input type="checkbox"/> Diesel—Gas Engines AVIATION <input type="checkbox"/> Aeronautical Engineering Jr. <input type="checkbox"/> Aircraft Engine Mechanic <input type="checkbox"/> Airplane Drafting BUILDING <input type="checkbox"/> Architecture <input type="checkbox"/> Arch. Drafting <input type="checkbox"/> Building Contractor <input type="checkbox"/> Estimating <input type="checkbox"/> Carpenter and Mill Work <input type="checkbox"/> Carpenter Foreman <input type="checkbox"/> Reading Blueprints <input type="checkbox"/> House Planning <input type="checkbox"/> Plumbing | <ul style="list-style-type: none"> <input type="checkbox"/> Heating <input type="checkbox"/> Steam Fitting <input type="checkbox"/> Air Conditioning <input type="checkbox"/> Electrician BUSINESS <input type="checkbox"/> Business Administration <input type="checkbox"/> Certified Public Accountant <input type="checkbox"/> Accounting <input type="checkbox"/> Bookkeeping <input type="checkbox"/> Stenography and Typing <input type="checkbox"/> Secretarial <input type="checkbox"/> Federal Tax <input type="checkbox"/> Business Correspondence <input type="checkbox"/> Personnel and Labor Relations <input type="checkbox"/> Advertising <input type="checkbox"/> Retail Business Management <input type="checkbox"/> Managing Small Business <input type="checkbox"/> Sales Management <input type="checkbox"/> Salesmanship <input type="checkbox"/> Traffic Management CHEMISTRY <input type="checkbox"/> Chemical Engineering <input type="checkbox"/> Chemistry <input type="checkbox"/> Analytical Chemistry <input type="checkbox"/> Petroleum—Nat'l Gas <input type="checkbox"/> Pulp and Paper Making <input type="checkbox"/> Plastics | <p>CIVIL, STRUCTURAL ENGINEERING</p> <ul style="list-style-type: none"> <input type="checkbox"/> Civil Engineering <input type="checkbox"/> Structural Engineering <input type="checkbox"/> Surveying and Mapping <input type="checkbox"/> Structural Drafting <input type="checkbox"/> Highway Engineering <input type="checkbox"/> Reading Blueprints <input type="checkbox"/> Concrete Construction <input type="checkbox"/> Sanitary Engineering DRAFTING <input type="checkbox"/> Aircraft Drafting <input type="checkbox"/> Architectural Drafting <input type="checkbox"/> Electrical Drafting <input type="checkbox"/> Mechanical Drafting <input type="checkbox"/> Structural Drafting <input type="checkbox"/> Sheet Metal Drafting <input type="checkbox"/> Mine Surveying and Drafting ELECTRICAL <input type="checkbox"/> Electrical Engineering <input type="checkbox"/> Electrician <input type="checkbox"/> Electrical Maintenance <input type="checkbox"/> Electrical Drafting <input type="checkbox"/> Electric Power and Light <input type="checkbox"/> Lineman HIGH SCHOOL <input type="checkbox"/> High School Subjects | <ul style="list-style-type: none"> <input type="checkbox"/> College Preparatory <input type="checkbox"/> Mathematics <input type="checkbox"/> Commercial <input type="checkbox"/> Good English MECHANICAL AND SHOP <input type="checkbox"/> Mechanical Engineering <input type="checkbox"/> Industrial Engineering <input type="checkbox"/> Industrial Supervision <input type="checkbox"/> Foremanship <input type="checkbox"/> Mechanical Drafting <input type="checkbox"/> Machine Design-Drafting <input type="checkbox"/> Machine Shop Practice <input type="checkbox"/> Tool Design <input type="checkbox"/> Industrial Instrumentation <input type="checkbox"/> Machine Shop Inspection <input type="checkbox"/> Reading Blueprints <input type="checkbox"/> Toolmaking <input type="checkbox"/> Gas—Electric Welding <input type="checkbox"/> Heat Treatment—Metallurgy <input type="checkbox"/> Sheet Metal Work <input type="checkbox"/> Sheet Metal Pattern Drafting <input type="checkbox"/> Refrigeration POWER <input type="checkbox"/> Combustion Engineering <input type="checkbox"/> Diesel—Electric <input type="checkbox"/> Electric Light and Power | <ul style="list-style-type: none"> <input type="checkbox"/> Stationary Steam Engineering <input type="checkbox"/> Stationary Fireman RADIO, TELEVISION, COMMUNICATIONS <input type="checkbox"/> General Radio <input type="checkbox"/> Radio Operation <input type="checkbox"/> Radio Servicing—FM <input type="checkbox"/> Television <input type="checkbox"/> Electronics <input type="checkbox"/> Telephone Work RAILROAD <input type="checkbox"/> Locomotive Engineer <input type="checkbox"/> Diesel Locomotive <input type="checkbox"/> Air Brakes <input type="checkbox"/> Car Inspector <input type="checkbox"/> Railroad Administration TEXTILE <input type="checkbox"/> Textile Engineering <input type="checkbox"/> Cotton Manufacture <input type="checkbox"/> Rayon Manufacture <input type="checkbox"/> Woolen Manufacture <input type="checkbox"/> Loom Fixing <input type="checkbox"/> Finishing and Dyeing <input type="checkbox"/> Textile Designing HOME ARTS <input type="checkbox"/> Dressmaking and Designing <input type="checkbox"/> Cookery <input type="checkbox"/> Tea Room Management |
|---|---|---|---|--|

Name _____ Age _____ Home Address _____

City _____ State _____ Working Hours _____ A.M. to _____ P.M.

Occupation _____

Special tuition rates to members of the Armed Forces. Canadian residents send coupon to International Correspondence Schools Canadian, Ltd., Montreal, Canada

**SMASH
HIT!**

TERRIFIC ACCEPTANCE GREETS THE NEW

**TRIO
ZIG-ZAG**
(Patent Pending)

TV ANTENNA



TRIO ZIG-ZAG
TV ANTENNAS

The sensational new TRIO ZIG-ZAG TV ANTENNA has already proven its superiority in the field. Thousands of installations have given a new high in TV reception, especially in ultra-fringe areas. Word of mouth has done the rest. TRIO'S plant capacity, taxed to the limit in an effort to supply the amazing demand for the ZIG-ZAG ANTENNA series, is being greatly expanded. Very soon now, your ZIG-ZAG ANTENNA will be supplied, and it's well worth waiting for.

ZIG-ZAG ANTENNAS have replaced every known type of installation and TRIO is proud to report that in EVERY instance the ZIG-ZAG ANTENNA has out-performed them all, even the tried and true TRIO dual-channel yagi.

TV listeners are finding that with a ZIG-ZAG ANTENNA they are no longer tied down to just one or two channels, but are getting excellent reception on channels never seen before. ZIG-ZAG ANTENNA is truly HOT on all VHF channels.

available in 8 different models, provide a new high in all-channel performance for any area, from metropolitan to ultra-fringe. Tremendous gain, sharp directivity, excellent match to 300 ohm line, sturdy vibration-proof construction and fast, easy installation tells the rest of the TRIO ZIG-ZAG ANTENNA story.

SEE THEM at your JOBBERS. WRITE for CATALOG.



TRIO ROTATOR

A worthy companion to the ZIG-ZAG ANTENNA. Tested and proven under every conceivable condition of load, weather, strain and stress. Two motors, one for each rotation direction. Positive electrical stops prevent damage of over-rotation. Positive brake action, no drift even when supporting heavy arrays in 80 MPH winds. Precision built of finest materials and UNCONDITIONALLY GUARANTEED by TRIO for TWO YEARS. SMARTLY STYLED DIRECTION INDICATOR has easy to read dial face and easy to use finger touch control. A beautiful instrument you'll be proud to own.

These ZIG-ZAG ANTENNAS provide the ultimate in extreme fringe area reception. ZZ12L provides 12-14 db. gain on Channels 2 thru 6. ZZ16H has a gain of 14 db. on Channels 7 thru 13. These antennas have very narrow forward lobe, high front to back ratio, provide high rejection in areas with co-channel interference.

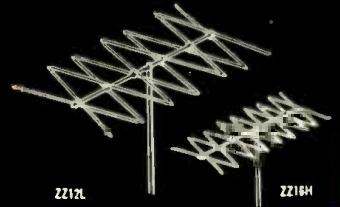

ZZ12L

ZZ16H

Where maximum gain is not necessary these normal fringe model ZIG-ZAG ANTENNAS are ideal. Model ZZ8L has a gain of 9 db. average on Channels 2 thru 6. The ZZ8H provides an 11 db. gain on Channels 7 thru 13. Forward lobe patterns comparable to good multi-element single channel yagi.



ZZ8L

ZZ8H

For near fringe area reception these ZIG-ZAG ANTENNA models provide 8-9 db. gains on all Channels 2 thru 13. ZZ6L covers Channels 2 thru 6 and Model ZZ6H covers Channels 7 thru 13. Both models have patterns similar to those of cut to channel yagis.



ZZ6L

ZZ6H

These ZIG-ZAG ANTENNAS provide ALL CHANNEL reception with only ONE antenna bay. Model ZZ6A is designed for near fringe area reception of all Channels 2 thru 13, with an average gain of 9 db. Model ZZ4A is for use in suburban areas, providing an average gain of 6 db. on all Channels 2 thru 13.

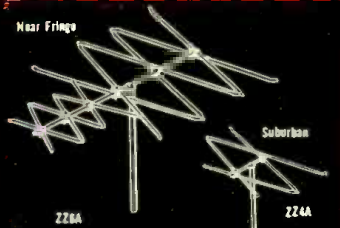

ZZ6A

ZZ4A



TRIO MANUFACTURING COMPANY

GRIGGSVILLE, ILLINOIS

DEALERS GETTING WESTINGHOUSE TUBES PROFIT FROM HEAVY LOCAL ADVERTISING AT NO COST

Service dealers are getting powerful local advertising support from new Westinghouse RELIATRON™ Tube Distributors. In cities now served by Westinghouse Distributors, dealers get local newspaper advertising, a complete kit of store display and imprinted mailing material.

All of it—local ads and kits—are designed to build TV-radio service business in the dealer's local area.

Best of all, none of it costs the dealer a penny!

You can get your store listed in two local newspaper ads at no charge, and get a kit to boot. If Westinghouse Tubes are now sold in your area, see your Westinghouse Distributor and take advantage of this \$900-worth-of-advertising-at-no-cost offer.



COMING YOUR WAY

If Westinghouse Tubes are not yet distributed in your area, be patient. Distributors are being established in all market areas as fast as product availability and good service permit.

You'll soon have the chance to buy RELIATRON Tubes. Keep this tremendous opportunity in mind: you'll get newspaper advertising at no cost! Imprinted material for mailings! Imprinted signs for your window!

All of it is local advertising which sells your service in your own area where it counts.

For the name of your Westinghouse Distributor, or the approximate date when Westinghouse Tubes will be available in your area, drop a postal card to Dept. G-201 or have your regular distributor contact Dept. G-201 for information on how he can better serve you.

RELIATRON™ TUBES

ELECTRONIC
TUBE DIVISION

Westinghouse Electric Corporation
Box 284, Elmira, N. Y.

YOU CAN BE SURE...IF IT'S
Westinghouse

Sweeping the Country!

**BUY DIRECT
AND SAVE**

'PRE-FAB'

COLLINS

TUNERS and RECEIVERS

AUDIO PRODUCTS CO.

Collins Audio Products Co. is in no way affiliated with Collins Radio Co.

Two ALL NEW Complete Kits for
Every High-Fidelity Need

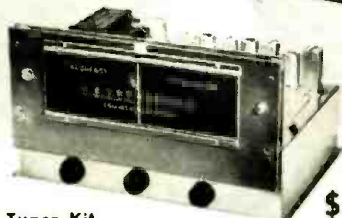

FM Tuner Kit

\$55

The FM-11 tuner is available in kit form with the IF Amplifier mounted in the chassis, wired and tested by us. You mount the completed RF Tuning Unit and power supply, then after some simple wiring, it's all set to operate. 11 tubes: 6J6 RF amp, 6AG5 converter, 6C4 oscillator, 6BA6 1st IF, (2) 6AU6 2nd and 3rd IF, (2) 6AU6 limiters, 6AL5 discriminator, 6AL7-GT double tuning eye, 5Y3-GT rectifier. Sensitivity 6 to 10 microvolts, less than 1/2 of 1% distortion, 20 to 20,000 cycle response with 2DB variation. Chassis dimensions: 12 1/2" wide, 8" deep, 7" high. Illustrated manual supplied. Shipping weight 14 lbs.

Each Collins Tuner Kit is complete with punched chassis, tubes, power transformer, power supply components, hardware, dial assembly, tuning eye, knobs, wire, etc., as well as the completed sub-assemblies: FM tuning units, AM tuning units, IF amplifiers, etc., where applicable. Since all these sub-assemblies are wired, tested and aligned at the factory, Collins Pre-Fab Kits are easily assembled even without technical knowledge. The end result is a fine, high quality, high fidelity instrument at often less than half the cost—because you helped make it and bought it direct from the factory. Bring your present reproducing system up to date with a new Collins Tuner.



FM/AM Tuner Kit

\$77⁵⁰

The original 15 tube deluxe FM/AM pre-fab kit redesigned on a smaller chassis. The tuner now measures 14" wide by 12" deep by 7 1/2" high. This attractive new front and dial assembly opens up new applications where space is at a premium. Kit includes everything necessary to put it into operation—punched chassis, tubes, wired and aligned components, power supply, hardware, etc. Kit comprises FMF-3 tuning unit, IF-6 amplifier, AM-4 AM tuning unit, magic eye assembly and complete instructions. All tubes included. Shipping weight 19 lbs.

Selected Basic Components For Special Applications

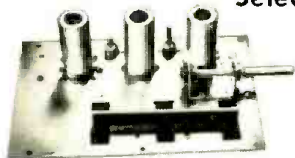

FMF-3 Tuning Unit

\$15²⁵

The best for FM. The most sensitive and most selective type of "front end" on the market. 6 to 10 microvolts sensitivity. Image ratio 500 to 1. 6J6 tuned RF stage, 6AG5 converter, 6C4 oscillator. Permeability tuned, stable and drift-free. Chassis plate measures 6 1/2" x 4 1/2". In combination with the IF-6 amplifier, the highest order of sensitivity on FM can be attained. Tubes included as well as schematic and instructions. Draws 30 ma. Shipping weight FMF-3: 2 1/2 lbs. Dial available @ \$3.85



IF-6 Amplifier

\$19⁷⁵

A remarkable value! 6 tubes are used in the IF amplifier: 6BA6 1st IF, (2) 6AU6 2nd and 3rd IF's, (2) 6AU6 limiters and 6AL5 discriminator. High gain, wide-band response (200 KC) for highest fidelity. 20 to 20,000 cycles. Distortion less than 1/2 of 1%. Draws 40 ma @ 220 volts. Chassis plate dimensions: 11-5/16" x 2 1/2" Shipping weight: 3 lbs.



AM-4 Tuning Unit

\$24⁵⁰

Tops in AM superhet performance! A 3-gang tuning condenser gives 3 tuned stages with high sensitivity and selectivity. Assembly is completely wired, tested and aligned ready for immediate use. Frequency coverage 540 KC to 1650 KC at a sensitivity of 5 microvolts. Tubes 6BA6 RF amplifier; 6BE6 converter; 6BA6 IF amplifier and 6AT6 detector. Draws 30 ma @ 220 volts. Mounts on a chassis plate measuring 4" x 7 3/8". Shipping weight 2 1/2 lbs. Dial available at \$3.85.



RD-1C Tuner & Dial

\$28⁵⁰

The COLLINS RD-1C FM tuner chassis is unique in the field. A whole, compact FM tuner and dial that fits in the palm of your hand. Convert AM sets to FM/AM receivers for only a few dollars! Unlimited applications where space is at a premium. Use in conjunction with your phonograph amplifier. Full frequency response to 20,000 cycles. Sensitivity 20 microvolts, permeability tuned. Tuning unit and IF amplifier on the same chassis plate. Draws 40 ma @ 100 volts. Tubes: 6AG5 converter, 6C4 oscillator, (2) 6AU6 IF amplifiers, 6AL5 in new ratio detector circuit Shipping weight tuner and dial 5 lbs.

**MAIL
COUPON
TODAY**

To: Collins Audio Products Co. Inc.
P.O. Box 368, Westfield, N. J.
Tel. Westfield 2-4390

- FM Tuner Kit FM/AM Tuner Kit Slide Rule Dial Assembly
 FMF-3 Tuning Unit IF-6 Amplifier RD-1C Tuner and Dial
 AM-4 Tuning Unit

NAME _____

ADDRESS _____

CITY _____ STATE _____

Amount for Kit \$ _____ See weights, add shipping cost \$ _____

Total amount enclosed \$ _____ Check Money Order

WHEN YOU THINK OF TUNERS, THINK OF COLLINS AUDIO PRODUCTS

SYLVANIA PICTURE TUBES

Lasted Longer than others tested!

"IT'S A TRUE
BLUE-RIBBON
TUBE"



BEST IN
OVER-ALL
POINT
QUALITY!



SYLVANIA
OUTLASTED
ALL TUBES
TESTED



**Only Sylvania tubes showed NO FAILURES
after 1400 hours . . . at accelerated voltages**

Exhaustive tests conducted under the supervision of an outside impartial laboratory, the United States Testing Company, showed Sylvania Picture Tubes lasted longer than any others tested.

These tests included the picture tubes of nine leading manufacturers. All tubes were placed in identical test racks and tested under identical accelerated voltages. At the end of 1400 hours, only the Sylvania

Picture Tubes showed *no failures*.

These tests definitely establish the outstanding dependability of Sylvania Picture Tubes. They prove that these tubes will best uphold your reputation for fine performance in the sets you manufacture, sell or service. Send today for complete details about Sylvania Picture Tubes. Sylvania Electric Products Inc., Dept. 3R-2101, 1740 Broadway, New York 19, New York.

TESTS CONDUCTED
BY U.S. TESTING
COMPANY



SYLVANIA

RADIO TUBES; TELEVISION PICTURE TUBES; ELECTRONIC PRODUCTS; ELECTRONIC TEST EQUIPMENT; FLUORESCENT TUBES, FIXTURES, SIGN TUBING, WIRING DEVICES; LIGHT BULBS; PHOTOLAMPS; TELEVISION SETS

NEW! RCP

Model 740 TV 'DO-ALL' GENERATOR

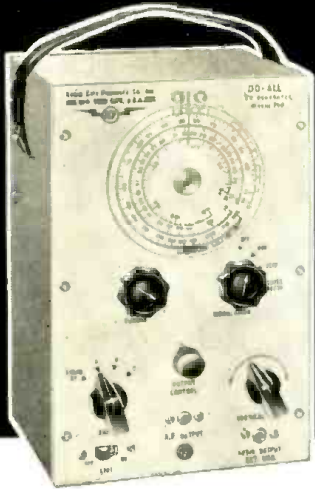

HERE—AT LAST! One compact, efficient instrument which gives the performance of several combined instruments—each of which is higher priced and all of which are needed for properly servicing TV and FM Receivers.

SIGNAL GENERATOR . . .

Generates a modulated or unmodulated carrier signal covering every channel (VHF) and every IF band on any TV or FM Receiver—ALL ON FUNDAMENTALS. 9 meg—220 meg. It will supply a 540 cycle audio signal of the audio output.

MARKER GENERATOR . . .

Accurate to within 1/10 of 1% on 9-11 megacycle band, and better than 1/2 of 1% overall. Perfect for alignment.

PATTERN GENERATOR . . .

Produces either horizontal or vertical bars or cross hatch.

The only single easily portable instrument that provides for testing and alignment of: Front Ends, IF's, Horizontal and Vertical Linearity, Syncs, Sweeps, Size, Position, Focus Coil, Deflection Coil, Ion Trap.

Unusually fine circuit design, extreme stability, rugged mechanical construction. Smart looking unit with brushed aluminum etched panel and dial. Size: 10" x 6" x 6".

Weight: 8 lbs.

Model 740—Complete, ready to operate

\$69.50
NET

For the "GREATEST VALUE PER DOLLAR IN TV-RADIO TEST EQUIPMENT" send for the new colorful, fully illustrated 1953 RCP catalog. Complete details on Model 740 and other instruments in this top-quality line are shown.

MAIL COUPON NOW FOR

FREE CATALOG

RADIO CITY PRODUCTS CO., Inc.
Dept. RN-1, 152 West 25th St., N. Y. 1, N. Y.

Please send me a copy of your new 1953 colorful, fully illustrated catalog featuring the top-quality RCP instrument line.

NAME.....

ADDRESS.....

CITY.....STATE.....

Within the INDUSTRY

A.I.E.E. will hold its 1953 Winter General Meeting January 19-23 at the Hotel Statler in New York. Some 4000 of the nation's leading engineers, scientists, and research men and women are expected to attend.

L. F. Hickernell, chief engineer at *Anaconda Wire & Cable Co.*, has been appointed chairman of the technical program committee. This committee will supervise sixteen daily technical sessions. They will be held simultaneously and, during the five day period, will cover every field of electrical engineering and related sciences.

GORDON C. KNIGHT has been named assistant to the president of *International Telephone and Telegraph Corporation*.



Active in management and industrial relations since 1941, Mr. Knight joins *IT&T* from its subsidiary, the *Capehart - Farnsworth Corporation*, where he served successively as assistant to the president, division manager of research and development, and operations manager of the commercial products division.

He served four years with the U.S. Navy Amphibious Forces during World War II and held the rank of lieutenant at the time of his discharge.

ADMIRAL CORPORATION has announced construction of a new 46,000 square foot addition to its television plant in Bloomington, Illinois. The new plant contains television installation lines, storage for cabinets, tubes and other components, and warehouse space for finished products. . . . **HALLMARK ELECTRONIC CORPORATION**, Newark distributing firm, has moved to new and larger quarters at 85 Monticello Avenue in Newark. The new facility provides over 7000 square feet of sales and storage space. . . . **JAVEX**, manufacturer of meters and electronic devices, has moved to Redlands, California from Garland, Texas. The company is occupying a new plant on its recently-purchased 25-acre site in Redlands. . . . **SYLVANIA ELECTRIC PRODUCTS INC.** has dedicated its new electronics division headquarters in Woburn, Massachusetts. The new 50,000 square foot plant employs approximately 850 persons and will serve as the headquarters for the administrative, sales, engineering, and manufacturing staffs of the electronics division as well as serve as the site of the principal manufacturing operations. . . . **SPIRLING PRODUCTS INC.** has moved its manufacturing facilities from 62

Grand Street in New York to a new, modern plant on Henrietta Street at Duffy Avenue in Oyster Bay, Long Island. . . . Television production is now underway at Plant No. 5 of the **RAYTHEON TELEVISION AND RADIO CORPORATION**. The new facility, located at 51st Street and Cottage Grove Avenue in Chicago, will be devoted exclusively to the production of TV receivers.

CRESTWOOD RECORDER CORPORATION of Chicago has been purchased by **DAYSTROM ELECTRIC CORPORATION**, subsidiary of **DAYSTROM, INCORPORATED**, Elizabeth, N. J. firm. H. H. Hanlon, president of *Crestwood*, will continue as sales manager of the new subsidiary and will direct national distribution. . . . **MAGNETIC RESEARCH CORP.**, El Segundo, California, is a newly-formed company specializing in the research, development, and production of magnetic devices. Hugo Woerdemann heads the new firm which has offices at 318 Kansas Street in El Segundo. . . . Edward T. Clegg has resigned his post as chief engineer of **KUTHE LABORATORIES** to form a new company, **CLEGG LABORATORIES, INC.** The new firm will develop and build instruments and equipment for the radar pulse generation field and will later enter the u.h.f. component and equipment market, catering to the ham. The company's main office is at 410 John Street, East Newark, N. J. . . . A new firm for the manufacture of electrical, electronic, and nuclear products has been formed under the name **PLASTIC CAPACITORS, INC.** Stephen Meskan heads the new organization which is located at 2511 W. Moffat Street, Chicago 47.

JAMES A. COMSTOCK has been named president of *Acme Electric Corporation*, Cuba, N. Y., while Charles H. Bunch has been elevated to the post of chairman of the board. Mr. Comstock joined the company in 1930 as chief engineer. He has served as purchasing agent, manager of specialty transformer and radio transformer sales, general manager of the Clyde, N. Y. plant of the company, and, since 1946, as executive vice-president.



FRANK W. MANSFIELD of *Sylvania Electric Products Inc.* has been reappointed chairman of the Industry Statistics Committee of the Radio-Television Manufacturers Association.



Leonard C. Lane, B.S., M.A.
 President of Radio-Television
 Training Association, Exec. Dir.
 of Pierce School of Radio and
 Television.



**I GIVE YOU
 MORE EQUIPMENT
 TO TRAIN YOU BETTER**

Set up your own home laboratory with the 15 BIG TV-Radio kits we send you. You build AND KEEP your own complete BIG SCREEN TV RECEIVER, Super-Het Radio Receiver, R.F. Signal Generator, Combination Voltmeter-Ammeter-Ohmmeter, C-W Telephone Receiver, AC-DC Power Supply. Everything is furnished complete, including all tubes, plus big TV picture tube.

**GET MORE!
 LEARN MORE!
 EARN MORE!**

THOUSANDS OF NEW JOBS IN

TELEVISION

I PREPARE YOU AT HOME IN YOUR SPARE TIME

MORE TRAINING TO FIT YOU FOR THE BETTER PAY JOBS

Thousands of new jobs will open up right in your own state, now that the government has lifted restrictions on new TV stations. My simple, successful methods have helped hundreds of men — most of them with NO PREVIOUS TRAINING — find places in America's booming TELEVISION and Electronics Industries. You too can get the success and happiness you always wanted out of life within months... studying at home... as I train you to become a full-fledged TV TECHNICIAN. Many of my students make as much as \$25.00 a week repairing Radio-TV sets in their spare time while learning... pay their entire training almost from the very beginning from spare time earnings... start their own profitable service business.

But I don't stop after I qualify you as a TV Technician... although right there you can choose from among dozens of fascinating careers! I continue to train you — AT NO EXTRA COST — to qualify for even better pay in the BETTER JOBS that demand FCC licenses, with my...

**MORE VALUE!
 YOU GET A ROUND TRIP TO
 NEW YORK CITY
 AT NO EXTRA COST**

FROM ANYWHERE IN THE U.S. OR CANADA — I pay your way to New York and return, PLUS 2 FREE weeks, 50 hours of advanced instruction and shop training at the PIERCE SCHOOL OF RADIO & TELEVISION. You use modern electronics equipment, including student-operated TV and Radio stations. You go behind the scenes of New York's big Radio-TV centers, to study first hand. And I give you all this AT NO EXTRA COST! (Applies to complete Radio-TV course only.)

Only RTTA makes this amazing offer.

I GET MY GRADUATES GOOD PAYING JOBS

"Thanks to your training, I qualified for a good job as a Receiver Tester at Federal Telephone and Radio."
 — Paul Frank Seier



"I'm making good money in my own business, repairing and installing radio and TV sets — thanks to your training."
 — Irwin Polansky



"Your excellent instruction helped me get my present job as an airport radio mechanic for American Airlines."
 — Eugene E. Basko



"I'll always be grateful to your training which helped me get my present fine position as Assistant Parts Manager."
 — Norman Weston



Many others working at NBC, RCA, CBS, DuMont, Philco, Emerson, Admiral and other leading firms.

FREE FCC COACHING COURSE
 PREPARES YOU AT HOME FOR YOUR FCC LICENSE.
 THE BEST JOBS IN TV AND RADIO REQUIRE AN FCC LICENSE.
 Given at NO EXTRA COST after TV Theory and Practice is completed.

NOW! ADVANCED FM-TV TRAINING
 If you have previous Armed Forces or civilian radio experience—my ADVANCED COURSE can save you months of training. Full theory and practical training... complete with kits, including BIG SCREEN TV RECEIVER and FREE FCC License Coaching Course.

FREE EMPLOYMENT ASSISTANCE
 My vocational adviser will help you obtain a good-paying job in the locality of your choice.

VETERANS!

MY SCHOOLS FULLY APPROVED TO TRAIN VETERANS UNDER NEW G.I. BILL! If discharged after June 27, 1950 — CHECK COUPON BELOW!
 Also approved for RESIDENT TRAINING in New York City... qualifies you for full subsistence allowance up to \$160 per month.

MAIL COUPON TODAY!
 BOTH FREE! New Illustrated Book and Sample Lesson. Learn How My Simple Methods Make Success Easy!

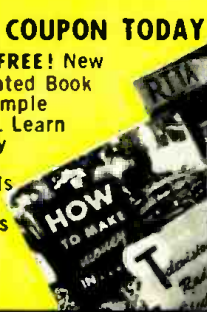

NO SALESMAN WILL CALL!

Mr. Leonard C. Lane, President
 RADIO-TELEVISION TRAINING ASSOCIATION
 1629 Broadway, Radio City Station
 New York 19, N. Y. Dept. T-1

Dear Mr. Lane: Mail me your NEW FREE BOOK and SAMPLE LESSON that will show me how I can make BIG MONEY in TELEVISION. I understand I am under no obligation and no salesman will call.
 (PLEASE PRINT PLAINLY)

Name _____ Age _____
 Address _____
 City _____ Zone _____ State _____

I am interested in: Radio-TV Advanced FM-TV.
 VETERANS: If qualified under new G.I. Bill, check your choice: Home Study Resident Study.

RADIO-TELEVISION TRAINING ASSOCIATION
 1629 Broadway, Radio City Station, New York City 19, N. Y.
 LICENSED BY THE STATE OF NEW YORK

EVERYBODY'S TALKING ABOUT NEWCOMB'S "AUDI-BALANCE"

PATENT APPLIED FOR

"The greatest amplifier improvement in recent years" . . . A godsend to both owner and service man." . . . "It used to take me hours to do what Audi-balance does in seconds." . . . "Does even better than I've been able to do with meters, this balances tubes dynamically." . . . "The problem has plagued us for years, it is now possible to keep perfect balance in output tubes consistently for lowest distortion." . . . "Audi-balance is the perfect solution."

Just one of the features that make the brand new Classic amplifiers by Newcomb so exciting. Write for catalog of 8 completely new home music amplifiers priced from \$39.50 to \$269.50 audiophile net.

The Classic 25

For the sound thrill of a lifetime this superb new 25 watt custom amplifier has every practical operational feature electronic engineering can offer you. Even more important is the incomparable listening pleasure it provides.



The Classic 15

This outstanding 15 watt amplifier is unique in luxury features and technical perfection at a surprisingly moderate cost. Its smartly designed remote control unit is a superlative piece of engineering, beautifully finished in brushed brass.

Substantial Installation Savings

Savings of as much as, or more than, the entire cost of these fine amplifiers are being reported by enthusiastic purchasers. This is due to their unique design which removes the usual necessity of a remote control being near the amplifier, tuner and changer. These items can now be installed in a hall closet or any similar out of the way location leaving only the beautiful remote control and

the speaker, with no messy confusion of wires, in the living room. No accessories connect directly to the remote control. All inputs connect only to the main amplifier. The savings in cabinetry and of installation labor are obvious and very real to those who take advantage of this new complete remote control design.

NEWCOMB

DEPT. F 6824 LEXINGTON AVENUE, HOLLYWOOD 38, CALIF.

15 years of quality leadership

Write for Catalog



The 21-man committee, under Chairman Mansfield, directs the Association's activities in collecting and compiling statistical information for the radio-television industry. During the last fiscal year, this committee supervised the establishment of a statistical department within RTMA headquarters and broadened the Association's activities in this field.

HOWARD BRIGGS, formerly assistant vice-president in charge of the *Hoffman* government contract office in Washington, D. C., has been appointed assistant to the president of *Hoffman Laboratories, Inc.* of Los Angeles.



Prior to joining the company in 1950, Mr. Briggs was vice-president in charge of sales for the *Howard Radio Co.* in Chicago, a position he held for 15 years.

In his new post, he will manage the military production phase of the corporation and will coordinate procurement, sales, manufacturing, and other related departments of the company.

A. E. ABEL has been appointed assistant director of engineering and research for *Bendix Radio Div.* . . . *The Brush Development Co.* has named **ALBERT J. W. NOVAK** to the post of assistant general sales manager . . . **HERBERT RIEGELMAN**, until recently a vice-president of *Montgomery Ward*, has been appointed manager of marketing for the receiver department of *General Electric* . . . **DR. E. F. W. ALEXANDERSON**, noted engineer and inventor, has joined *RCA* as a consultant. This new association returns him to the company he served as chief engineer from 1920 to 1924 . . . **VICTOR WELGE** has joined *P. R. Mallory & Co., Inc.* as associate director of engineering . . . **HENRY GOLDSMITH** has been appointed manager of the "Sonora" brand sales division of *Sonora Radio & Television Corp.* . . . **WILLIS E. CLEAVES** has joined *Bendix Radio Div.* as staff assistant to the general manager of the division. He was formerly with *Collins Radio Company* . . . **ANTON C. FISHER** is the new sales and advertising manager for *Fretco Inc.*, manufacturers of TV antennas and antenna accessories . . . **ABRAHAM HYMAN**, formerly supervisory electronic engineer for the CAA in New York, has joined the *JFD Mfg. Co.* as an electronic consultant . . . **DONALD L. HERR** has been elected president of *American Electronic Mfg., Inc.*, a newly-established Los Angeles firm . . . **R. CARROLL MANINGER** has been made acting director of the physical research and development department and **ARTHUR R. SOFFEL** named director of the instrument assembly and design department for *Vitro Corporation of America* . . . **GARDNER P. WILSON** has joined *Consolidated Engineering Corp.* as senior development engineer . . .

(Continued on page 101)

Here's your Opportunity



to prepare for a good job or a business of your own in TV SERVICING

There are today more good jobs open in TV Servicing than there are trained and experienced men to fill them. Yes, thousands of opportunities exist now for good-pay jobs offering employment security for years and years to come. Thousands of TV Servicing jobs are going begging. Do you want one of them?

Experts agree, that because of the critical shortage of trained and experienced TV Servicemen, and the tremendous future growth of the industry, no vocational field today offers more opportunities than TV Servicing.

The Big New Industry with a Great Future

Television is just in the beginning stages of its big industrial boom. Look at these amazing facts:

- Lifting the freeze on new TV stations will open many new TV areas and will improve the coverage of existing areas. The result will be an enormous demand for TV receivers.

- Within a few years over 1000 TV stations will be telecasting compared with 108 TV stations now on the air.

- Nearly one-half of all families living within the present TV areas do not yet own TV receivers.

- The new trans-continental video network plus better and more interesting programs plus larger viewing screens and color TV will increase the installation of new receivers, will induce present owners of 12-inch and smaller size viewing screens to buy newer model receivers.

- The power increases of many existing stations and improved reception range of current receivers will result in receivers being installed and serviced in the fringe areas of present stations.

- Under the FCC proposal, over 70 per cent of all communities will be served by UHF channels exclusively. This means TV servicemen must know UHF receivers before the new UHF stations in their area are opened.

- No one yet knows how great the industrial TV market will be.

RCA Institutes Home Study Course prepares you for a Career in TV Servicing

The addition of the RCA Institutes TV Service Training to your present radio-electronics experience will qualify you to step out and grasp the golden opportunities that now exist in television—America's fastest growing industry.

Learn at home—in your spare time—while you study the practical *how-to-do-it* techniques with *how-it-works* information. Easy-to-read and easy-to-understand lessons under the supervision of RCA engineers and experienced instructors quickly train you to qualify for the many good jobs now waiting for trained TV servicemen. Don't pass up this lifetime opportunity for financial security and a bright future in TV. Learn TV Servicing from RCA—pioneers and leaders in radio, television and electronic developments.

RCA Institutes conducts a resident school in New York City offering day and evening courses in Radio and TV Servicing, Radio Code and Radio Operating, Radio Broadcasting, Advanced Technology. Write for free catalog on resident courses.



RCA INSTITUTES, INC.
A SERVICE OF RADIO CORPORATION of AMERICA
350 WEST FOURTH STREET, NEW YORK 14, N.Y.

Send for FREE BOOKLET

Mail the coupon—today. Get complete information on the RCA INSTITUTES Home Study Course in Television Servicing. Booklet gives you a general outline of the course by units. See how this practical home study course trains you quickly, easily. Mail coupon in envelope or paste on postal card.



MAIL COUPON NOW!

RCA INSTITUTES, INC., Home Study Department RN-153
350 West Fourth Street, New York 14, N. Y.

Without obligation on my part, please send me copy of booklet "RCA INSTITUTES Home Study Course in TELEVISION SERVICING." (No salesman will call.)

Name _____ (please print)

Address _____

City _____ Zone _____ State _____

Bill Clemens says—
 Midget Radio Service (a 3-Man Shop)
 129 S. Elizabeth St., Lima, Ohio

**"TRIPLITT 660 saves us
 50 to 100 man hours
 per month."**

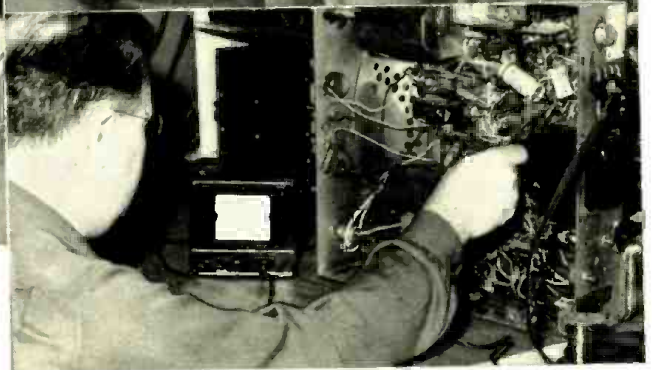

1. ISOLATING THE TROUBLE—Plug the power cord of the chassis into LOADCHEK and note the reading. With your eye on the large meter remove the rectifier tube and you can tell immediately which side of the tube the trouble is on. You have already eliminated 50% of your probing time.

2. LOCATING THE SHORT—With Loadchek you can quickly check the shorted side, part by part, without laying down tools or picking up test leads. Here, the trouble was a short in the transformer, spotted without having to warm up set. Overloads are found the same way.

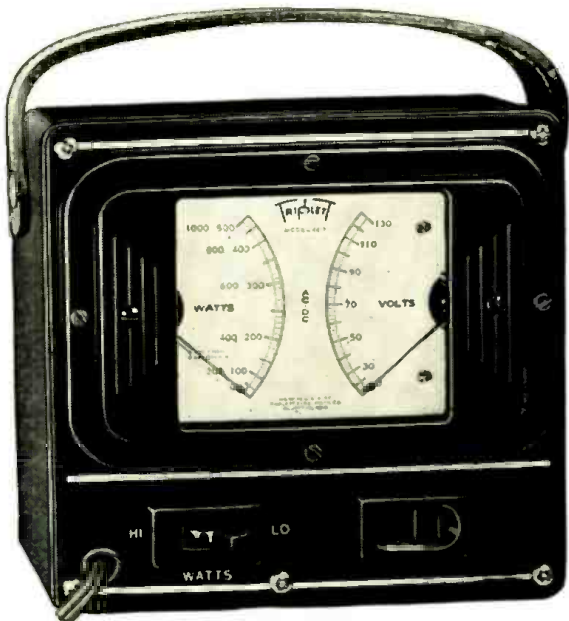

Locates trouble in a hurry

The above pictures illustrate but one of the many time-saving uses of Triplitt 660 Loadchek. This versatile instrument accurately measures power consumption, enables you to see instantly any deviation from normal load, without disconnecting a single part... finds trouble in a hurry.

For Radio and TV servicing—for almost any kind of electrical trouble-shooting—LOADCHEK saves hours of painstaking work every day. At its moderate cost no service technician can afford to be without it. Try one today—and see! Write for free booklet.

TRIPLITT ELECTRICAL INSTRUMENT CO., BLUFFTON, OHIO, U.S.A.

Suggested U. S. A. DEALER NET \$29⁵⁰
 Price subject to change without notice.



Triplitt



**TRAIN *FASTER*—TRAIN *BETTER*—TRAIN *EASIER*
IN 10 MONTHS—OR LESS—FOR
RADIO-TELEVISION**

Our 21st Year Training Men for Greater Incomes and Security in Radio-Television

**I SEND YOU
18 BIG KITS**

of Radio-Television parts and equipment. Much of your training will be actual construction and experimentation . . . the kind of truly PRACTICAL instruction that prepares you for your Radio-Television career.



Frank L. Sprayberry
President
Sprayberry Academy
of Radio

NEW! NO OBLIGATION PLAN

**You Have No Monthly Payment Contract to Sign
Pay For Your Training as You Earn and Learn**

You can get into Radio-Television, today's fastest growing big money opportunity field, in *months* instead of years! My completely new "package unit" training plan prepares you in as little as 10 months or even less! *No monthly payment contract to sign—thus NO RISK to you!*

This is America's finest, most complete, practical training—gets you ready to handle any practical job in the booming Radio-Television industry. Start your own profitable Radio-Television shop . . . or accept a good paying job. I have trained hundreds of successful Radio-Television technicians during the past 21 years—and stand ready to train you, even if you have no previous experience! Mail coupon and get all the facts—FREE!



**Valuable Equipment Included
With Training**

The new Sprayberry "package" plan includes many big kits of genuine, professional Radio-Television equipment. You perform over 300 demonstrations, experiments and construction projects. You build a powerful 6-tube 2-band radio set, multi-range test meter, signal generator, signal tracer, many other projects. All equipment and lessons are *yours to keep* . . . you have practically everything you need to set up your own profitable Radio-Television service shop.

Earn Extra Money While You Learn!

All your 10 months of training is IN YOUR HOME in spare hours. Keep on with your present job and income while learning. With each training "package" unit, you receive extra plans and "Business Builder" ideas for spare time Radio-Television jobs. New television stations everywhere, open vast new opportunities for trained Radio-Television Technicians—and those in training. If you expect to be in the armed forces later, there is no better preparation than practical Sprayberry Radio-Television training.

YOU BUILD the Television set and the powerful superhet radio receiver shown above. IN ADDITION to the other test units shown here (many are not shown because of lack of space). All equipment I send you is **YOURS TO KEEP.**

Approved for Veterans under the G. I. Bill

**SPRAYBERRY ACADEMY OF RADIO 111 NORTH CANAL ST.
Dept. 25-S, Chicago 6, Ill.**

**MAIL COUPON
TODAY!
NO OBLIGATION**

**SPRAYBERRY ACADEMY OF RADIO, Dept. 25-S
111 North Canal St., Chicago 6, Ill.**

Please rush to me all information on your 10-MONTH Radio-Television Training Plan. I understand this does not obligate me and that no salesman will call upon me. Be sure to include 3 books FREE.

Name..... Age.....

Address.....

City..... Zone..... State.....

I invite you to get all the facts—
**FREE TO YOU 3 BIG
RADIO-TELEVISION BOOKS**

I want you to have ALL the facts about my new 10-MONTH Radio-Television Training—without cost! Rush coupon for my three big Radio-Television books: "How to Make Money in Radio-Television," PLUS my new illustrated Television Bulletin PLUS an actual sample Sprayberry Lesson—ALL FREE. No obligation and no salesman will call. Mail coupon NOW!



EICO
TEST INSTRUMENTS

GUARDS CBS *Columbia*
HIGH STANDARDS OF
TELEVISION PRODUCTION QUALITY



In the CBS Columbia design laboratories, Al Goldberg takes some important readings with the EICO Model 221 Vacuum Tube Voltmeter and Model 555 Multimeter, as Harry R. Ashley looks on.



Mr. Al Goldberg, Assistant Chief Engineer of CBS-Columbia and Harry R. Ashley, President of EICO, inspecting the use of the EICO Model 221 Vacuum Tube Voltmeter and Model MVP-1 High Voltage Probe at the Sweep Frequency Troubleshooting Position on the CBS-Columbia Television production lines.

KITS-Wired Instruments

For Laboratory Precision at Lowest Cost—
the Leaders Look to **EICO!**

WHY does CBS-Columbia, Inc., one of America's great headline-makers in Television set production, use EICO Test Instruments on both its new Television production lines and in its design laboratories?

BECAUSE like Emerson, Tele-King, Teletone, Majestic, and many another famous TV manufacturer coast to coast, CBS-Columbia knows that

ONLY EICO TEST EQUIPMENT DELIVERS ALL 10 EICONOMICAL FEATURES

1. Laboratory Precision
2. Lowest Cost
3. Lifetime Dependability
4. Speedy Operation
5. Rugged Construction
6. Quality Components
7. Latest Engineering
8. Super-Simplified Assembly and Use Instructions
9. Laboratory-Styled Appearance
10. Exclusive EICO Make-Good Guarantee

Before You buy any higher-priced equipment, be sure You look at the **EICO** line—in *Wired* as well as *Kit form!* Each EICO product is jam-packed with unbelievable value. **YOU** be the judge—compare, see **EICO instruments today**—in stock at your local jobber—and **SAVE 50%! Write NOW for FREE newest Catalog 1R.**

FOLLOW THE LEADERS... INSIST ON EICO!



NEW 377K SINE & SQUARE WAVE AUDIO GEN.
KIT \$31.95. WIRED \$49.95



320K SIG. GEN.
KIT \$19.95. WIRED \$29.95
322K SIG. GEN.
KIT \$23.95. WIRED \$34.95



360K SWEEP GEN. KIT \$34.95
WIRED \$49.95



315K DELUXE SIG. GEN. KIT \$39.95
WIRED \$59.95



1040K BATTERY ELIM.
KIT \$25.95. WIRED \$34.95



1171K RES. DECADE BOX
KIT \$19.95
WIRED \$24.95



NEW 536K MULTIMETER
KIT \$12.90.
WIRED \$14.90.
1000 OHMS/VOLT

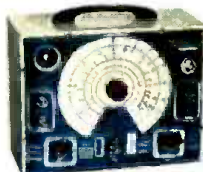

950K R.C. BRIDGE & R.C.L. COMP. KIT \$19.95
WIRED \$29.95



145K SIG. TRACER KIT
\$19.95
WIRED \$28.95



625K TUBE TESTER KIT \$34.95
WIRED \$49.95



221K VTVM
KIT \$25.95. WIRED \$49.95



CRA PIX TUBE ADAPTOR for Tube Tester \$4.50



NEW 214K VTVM KIT \$34.95.
WIRED \$54.95.
2 1/2" METER



NEW 565K MULTIMETER
KIT \$24.95.
WIRED \$29.95.
20,000 OHMS/VOLT



425K 5" PUSH-PULL SCOPE KIT \$44.95. WIRED \$79.95



HIGH VOLTAGE PROBE \$6.95

AMERICA'S GREATEST INSTRUMENT VALUES BEAR THE NAME—



ELECTRONIC INSTRUMENT CO., INC.
84 Withers Street, Brooklyn 11, N. Y.

©1952

Prices 5% higher on West Coast. Due to unstable conditions prices and specifications are subject to change without notice.

O SCILLOSCOPES

THE ELECTRONIC EYE OF THE SERVICE TECHNICIAN

By **MILTON S. KIVER**

Pres., Television Communications Institute

A survey of the various service-type oscilloscopes currently available and details on how instrument is used in radio and television repair operations.

THE introduction of television wrought many changes in the working habits of the radio technician. It caused him to develop a broader understanding of electronic circuits and a greater appreciation of what they can do. It introduced him to many new components and to many different types of circuits. And, above all, it brought into his daily life test instruments which he may have heard of, but which he seldom had occasion to use.

The most important of the new instruments, from the standpoint of utility, is the oscilloscope. For servicing, the technician can employ the oscilloscope to view directly the shapes of the waves present at various points in the television receiver. He can tell by inspection whether they possess the proper shape and he can determine by measurement whether they are attaining the desired amplitude.

For alignment, the oscilloscope is a natural companion to the sweep generator, depicting graphically the response curve of the circuit into which the sweep signal is fed. This not only

provides an instantaneous picture of circuit conditions as they exist, but any changes caused by adjusting coil cores and/or trimmer condensers become immediately apparent. The technician is thus kept fully informed at all times of the condition of the circuit being worked on.

There is a considerable amount of similarity between some of the operating controls on an oscilloscope and the operating controls of a television receiver. This is because an oscilloscope and the deflection circuits in a television receiver operate on the same basic principles. Thus, the "Intensity" control on the scope does exactly the same thing as the "Brightness" control on the television receiver. The same is true of "Focus" controls and of "Vertical" and "Horizontal" centering controls.

The oscilloscope is an impressive looking instrument with a seemingly endless array of controls. At least that is the impression the uninitiated get. To dispel this illusion and to fit these controls into a logical pattern, let us examine the basic diagram of an oscil-



The Triplet Model 3441 5" service-type oscilloscope.



Heath Company offers this Model O-8 scope in kit form.



Eico's Model 425K is another kit-type unit.

Radio City Products Company's Model 533M "Midgetscope" unit.

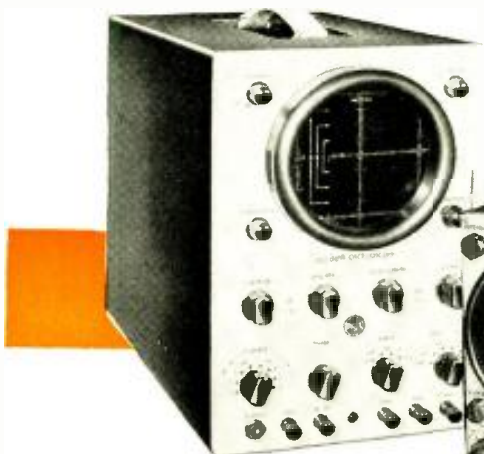
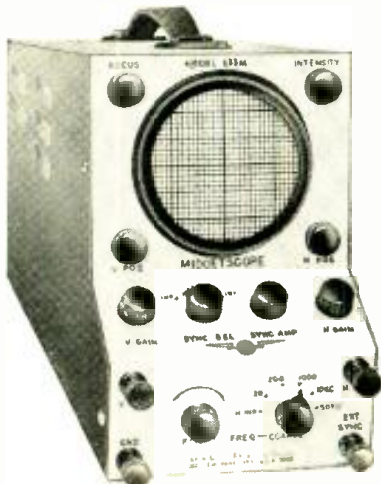

RCA's Model WO-88A, a 5" instrument for general service work.



RCA's WO-56A 7" oscilloscope for all types of servicing.

TABLE 1

Make & Model	Tube Size	Vertical Sensitivity	Bandpass (+0 - 3db.)	Phasing Control	Blanking Control	Intensity Mod.	Self Measurement of Peak-to-Peak	List Price	Remarks
COSSER Model 1039 B	3"	2.27 v. r.m.s./in. 13 v. r.m.s./in.	25 cps to 150 kc. 25 cps to 3.5 mc.	No	No	No	No	\$167.00	Designed for portable use. Weight 9 1/4 lbs. Size 11 1/2" x 5 1/2" x 4 1/2"
DU MONT Model 292	3"	.4 v. r.m.s./in.	5 cps to 100 kc.	No	See Note 2	No	See Note 1	135.00	
GENERAL ELECTRIC Model YNA-4	3"	A.C.—.18 v. r.m.s./in. D.C.—.5 v. d.c./in.	0-30 kc. +0, -15% 0-30 kc. +0, -15%	No	No	No	Yes	189.50	Vertical and horizontal amplifiers d.c. coupled. Designed primarily for industrial applications.
HICKOK Model 380	3"	75 mv. r.m.s./in.	0-2 mc.	No	Yes	No	No	215.00	Designed for portable use. Weight 14 lbs. Size 13 1/2" x 9" x 6"
RADIO CITY PRODUCTS Model 533M	3"	20 mv. r.m.s./in.	20 cps to 180 kc. (within ± 2 db)	No	No	No	No	99.50	Designed for portable use. Wt. 9 lbs. Size 11 3/4" x 7 3/4" x 5 1/8"
SUPREME Model 650	3"	.5 v. r.m.s./in.	20 cps to 100 kc.	No	No	No	No	99.95	
DU MONT Model 274-A	5"	.2 v. r.m.s./in.	5 cps to 110 kc.	No	See Note 2	Yes	See Note 1	135.00	
DU MONT Model 304A	5"	9 mv. r.m.s./in.	0 to 250 kc.	No	See Note 2	Yes	Yes	333.00	Flat face tube.
EICO Model 425K	5"	.1 v. r.m.s./in.	5 cps to 400 kc.	No	No	Yes	See Note 1	44.95 (in kit form)	Has detailed step-by-step instructions for construction.
EICO Model 430K	5"	20 mv. r.m.s./in.	10 cps to 1 mc. ± 2db	No	No	Yes	See Note 1	(in kit form)	New model.
ELECTRONIC MEASUREMENTS Model 600	5"	.02 v. r.m.s./in.	15 cps to 500 kc.	No	No	Yes	No	99.50	
EL-TRONICS Model WBO-50	5"	20 mv. r.m.s./in.	20 cps to 5 mc.	No	See Note 2	Yes	Yes	279.50	Sweep oscillator variable from 10 cycles to 150 kc. in 6 steps.
GENERAL ELECTRIC Model ST-2A	5"	A.C.—.15 mv. r.m.s./in. D.C.—.2 v. d.c./in.	20 cps to 500 kc. +0, -20% 0-500 kc. +0, -20%	No	No	Yes	Yes	327.50	Has special low capacity probe input terminal on front panel. Probe extra.
GENERAL ELECTRIC Model ST-2B	5"	A.C.—.10 mv. r.m.s./in. D.C.—.27 mv. d.c./in.	10 cps to 400 kc. +0, -20% 0-400 kc. +0, -20%	No	Yes	Yes	Yes	495.00	Available with short or long persistence CR tubes. Has special terminal for low capacity probe. Probe extra.
GENERAL ELECTRIC Model ST-2C	5"	.075 v. r.m.s./in.	20 cps to 3 mc.	No	No	Yes	Yes	374.25	Has special terminal for low capacity probe. Probe extra. Scope response not more than 50% down at 5 mc.
HEATH Model O-8	5"	25 mv. r.m.s./in.	10 cps to 800 kc.	No	No	Yes	See Note 1	43.50 (in kit form)	Has detailed step-by-step instructions for construction.
HICKOK Model 640	5"	15 mv. r.m.s./in. (1 mc.) 35 mv. r.m.s./in. (4.5 mc.)	0-4.5 mc.	Yes	No	Yes	Yes	355.00	Synchronization of pattern on either positive or negative peaks. Self contained beam blanking amplifier eliminates return trace when using saw-tooth sweep. Sync. line or 2X line freq. available.
HICKOK Model 670	5"	10 mv. r.m.s./in.	0-650 kc.	Yes	See Note 4	Yes	No	229.00	Same as Model 640.
JACKSON Model CRO-2	5"	18 mv. r.m.s./in. 25 mv. r.m.s./in.	20 cps to 100 kc. 20 cps to 4.5 mc.	No	Yes	Yes	Yes	197.50	User has choice of wide bandwidth and reduced sensitivity or reduced bandwidth and increased sensitivity.
PRECISION Model ES-500A	5"	20 mv. r.m.s./in.	0-1 mc.	Yes	Yes	Yes	Yes	173.70	Has vertical phase reversing switch, also many extras.
RCA Model WO-88A	5"	25 mv. r.m.s./in.	0-500 kc.	Yes	No	No	Yes	159.50	
SIMPSON Model 476	5"	18 mv. r.m.s./in.	20 cps to 300 kc.	No	No	Yes	See Note 1	197.00	
SUPREME Model 655	5"	.3 v. r.m.s./in.	20 cps to 100 kc.	No	No	No	No	126.50	
SUPREME Model 660	5"	.1 v. r.m.s./in.	5 cps to 5 mc. (within ± 2 db)	No	Yes	Yes	No	287.60	
TRIPLETT Model 3441	5"	10 mv. r.m.s./in. (See Note 6)	0-2 mc. (See Note 6)	Yes	Yes	Yes	Yes	199.50	70 v. (0 to 60,000 cycles) is made available from the internal saw-tooth osc. It can be used as an audio oscillator, or when checking to drive high-voltage unit of TV receiver.
PRECISE DEVELOPMENT Model 300	7"	10 mv. r.m.s./in.	0 to 5 mc.	Yes	Yes	Yes	Yes	79.95 (in kit form)	Has detailed step-by-step instructions for construction.
RCA Model WO-56A	7"	10.6 mv. r.m.s./in.	0-500 kc. (+0, -2 db)	Yes	No	No	Yes	217.50	Normal sweep trace can be expanded horizontally three times. Good for checking portions of waveforms.
SYLVANIA Model 132Z	7"	.1 v. r.m.s./in.	7 cps to 70 kc.	No	No	Yes	See Note 1	149.50	
SYLVANIA Model 400	7"	10 mv. r.m.s./in.	10 cps to 2 mc.	Yes	No	Yes	See Note 5	249.50	

See opposite page for applicable notes.

Sylvania's Model 132Z,
a 7" test instrument.

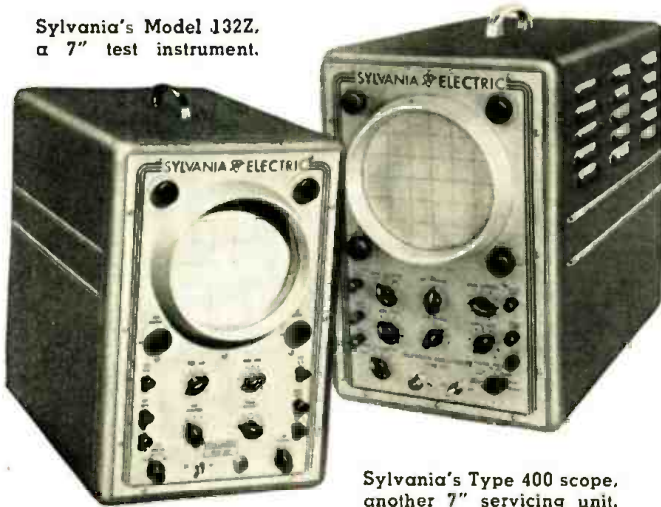

Sylvania's Type 400 scope,
another 7" servicing unit.

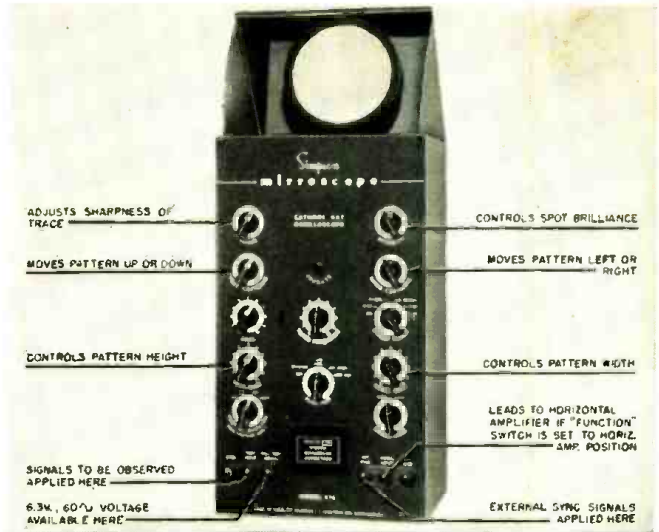

Fig. 1. Control functions on a representative scope. See text,

NOTES:

1. A 60-cycle voltage having an r.m.s. value of 6.3 volts is available at a front panel terminal. While not specifically designed for peak-to-peak voltage measurement, it can be adapted to this purpose.
2. There is no blanking control, but there is an internal retrace blanking circuit.
3. A 60-cycle test voltage of approximately .5 volt r.m.s. is available

- at a front panel terminal. This can be used for small peak-to-peak voltage measurements.
4. There is provision for blanking out return trace when a 60-cycle sinusoidal sweep is used.
5. A 60-cycle test voltage of approximately 25 volts is available at a rear panel terminal.
6. When scope rear switch is in 2 mc. position, sensitivity is 10 mv. r.m.s. per inch. When in 4 mc. position, sensitivity is 20 mv. r.m.s. per inch.

Notes applying to certain of the oscilloscopes covered in Table 1 appearing on page 32 (opposite).

loscope. This is shown in Fig. 2 (page 34). The heart of the instrument is the cathode-ray tube because it is on the screen of this tube that the incoming waves are traced out.

To produce the waveshape of applied signals, two sets of voltages must be applied to the cathode-ray tube. One of these voltages is the horizontal deflection voltage and this serves to move the beam slowly across the screen from left to right and then rapidly on retrace from right to left. If left by itself, all this voltage would do is produce a straight line horizontally across the screen. It is a saw-tooth voltage which is internally generated in the oscilloscope and then applied to the horizontal deflection plates via the horizontal amplifiers.

Positioned at right angles to the

horizontal deflection plates is another set of two plates. These are the vertical deflection plates. Here are applied the waves we wish to reproduce on the screen. Thus, as the beam is moved along (by the horizontal deflection voltage), it is also moved up or down by the incoming voltage. When the voltage applied to the vertical plates increases (say), the beam moves up; when it decreases, the beam moves down. (The reverse action may occur. Of importance only is the fact that positive voltages swing the beam in one vertical direction and negative voltages swing it in the opposite direction.) In this way the shape of any wave applied to the vertical deflection plates is traced out.

It is perfectly possible to apply voltages directly to the deflection plates

themselves and this is sometimes done. However, in order to obtain any sizable deflection of the beam, either straight across or up and down, a considerable amount of voltage is required. A much more flexible arrangement is achieved by inserting amplifiers between the deflection plates and the applied voltages. Now, sizable beam deflection can be obtained with input voltages on the order of millivolts.

In brief, then, the oscilloscope contains suitable amplifiers for the vertical and horizontal deflection voltages, a cathode-ray tube, a saw-tooth voltage generator, and a power supply. This is the basic circuit.

Oscilloscope Controls

The oscilloscope shown in Fig. 1 contains what might be termed an

Precision Apparatus Company's Model ES-500-A.



DuMont's Model 274-A
5" oscilloscope unit.



The Model 304-A, a 5"
scope made by DuMont.



DuMont's Model 292—a 3"
instrument for servicing.

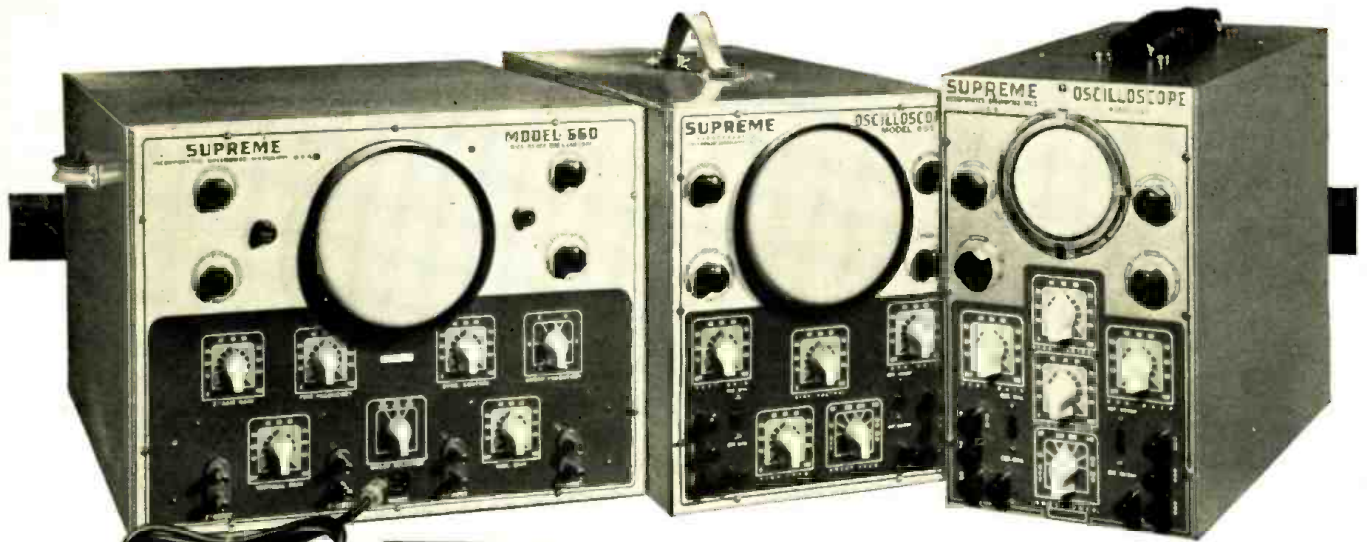

Model 655 scope by Supreme.
Supreme's Model 660 5" scope.

Supreme's 3" unit, Model 650.



El-Tronic's Model WBO-50 5" scope.



Jackson's 5" unit, the Model CRO-2.
Hickok's Model 670, a 5" unit.
The Model 640, also by Hickok.



average number of controls. The functions of the "Focus," "Intensity," and two centering controls are clearly indicated. In Fig. 1 they are the four top controls. They adjust easily and seldom cause trouble.

The next three controls, "Sync," "Range Frequency," and "Sweep Range," are all associated with the saw-tooth generator contained in this instrument. The simplest of these three controls, and actually the one to be set first, is the "Sweep Range" control. In the "Off" position, this control turns the saw-tooth generator off and the beam appears as a pin point of light at the center of the screen. The beam should not be permitted to remain stationary at one point or it will burn the screen, with the result that in future use this spot may become insensitive and not produce any light at all as the beam passes over it.

Beyond the "Off" position, the "Sweep Range" switch selects the frequency range for the horizontal saw-tooth (or linear) sweep. The first position beyond "Off" is labeled "15 to 75" cycles which means that the frequency of the saw-tooth deflection voltage produced will lie within this

range. (The frequency of the saw-tooth wave tells you how many times a second the beam sweeps across the screen from left to right and how many times it retraces. For example, a 60-cycle saw-tooth wave will move the beam 60 times per second from left to right and 60 times from right to left on retrace.) The exact frequency generated within this range will be determined by the position of the "Range Frequency" control. This control is a potentiometer and at the low end of its range the saw-tooth frequency is at its lowest point for any position of the "Sweep Range" switch; at the other end (extreme clockwise position) of the "Range Frequency" control, the saw-tooth sweeping range is at the upper limit of its range. In the case of the 15 to 75 cycle position, this would be 75 cycles (approximately).

Sweeping ranges of this particular instrument (of Fig. 1) extend from 15 cycles to 60,000 cycles, which is about average for most oscilloscopes. The upper frequency limit varies from 30,000 cycles (30 kc.) in some instruments to a high of 100,000 or 150,000 in others. The top figure of most
(Continued on page 87)

Fig. 2. Basic block diagram of an oscilloscope.

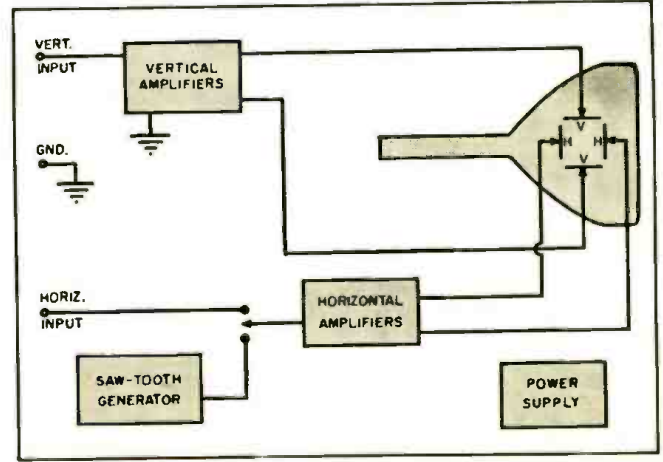

A PHOTOELECTRIC HEADLIGHT DIMMER

By

PETER J. VOGELGESANG

Engineering Research Associates, Inc.

PHOTOTUBES and photocells find almost limitless applications. They are used for everything from reproducing the sound track on motion picture film to controlling smoke in large industrial plants. Almost every month one sees some new and ingenious device designed around the singular properties of the phototube.

The application of the phototube as a headlight dimmer, while probably not very new and certainly not ingenious, is novel and the possessor of such a device will have something to appeal to his mechanical sensibilities.

The operation of this photoelectric headlight dimmer is very simple. Light from the headlights of an oncoming automobile strikes a phototube. The voltage change within the phototube is amplified by a two-stage, direct-current amplifier and the output of the amplifier actuates a sensitive relay. The sensitive relay, in turn, causes the headlights of one's own automobile to switch to the "low" position.

At first thought, the practicability of such a device seems doubtful because the circuit may be affected not only by light from oncoming autos but also by light from street lights, building lights, and even the full moon. It would seem that the headlights of one's auto would be popping up and down like a jack-in-the-box. A number of characteristics of the circuit prevent this from happening.

First, of course, the phototube is shielded to prevent incidental light from striking it. Only the light from in front of the auto will affect the device. The combination of resistance and capacitance in the input of the amplifier causes the circuit to respond slowly to sudden changes of light intensity either from light to dark or dark to light. This eliminates the possibility of the circuit "fluttering" or being actuated by passing autos and anything that might temporarily interrupt the light source. The bias on the first stage of the amplifier is

Internal view of the headlight "dimmer." It is housed in an 8" x 6" x 4" box.

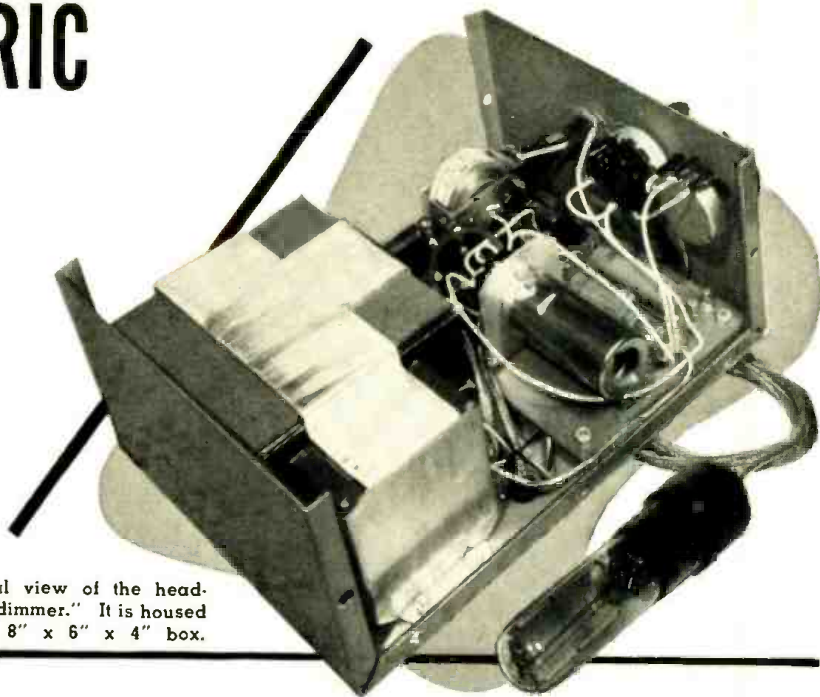

Construction details on a battery-operated headlight dimmer which is activated by single Type 868 phototube.

controlled by a potentiometer. This "threshold" control can be adjusted to compensate for any extraneous or residual light source such as a full moon or the light from one's own headlights reflected off a snow-covered highway. It also provides a means of adjusting the range or distance at which the headlights of oncoming autos will actuate the circuit. Like any armature relay, more current is required to close the sensitive relay than is required to keep it closed. In the circuit, once the headlights have been dimmed by a given intensity of light, much less light is needed to keep them dimmed. This eliminates the possibility of one's headlights reverting to the "high" position when the driver of an oncoming auto dims his lights.

The entire operation of this device is based upon the idea that if there is enough light to actuate the circuit,

there is enough light to see the road without the help of the "high" lights.

The circuit of the device is simplicity itself. An 868 gas phototube supplies the light sensitive element and a twin-triode 12AT7 vacuum tube is used as the two-stage, direct-current amplifier. The anode voltage for the phototube and the plate voltage for the triodes is supplied by two 90 volt "B" batteries. The grid bias for each triode is supplied by two separate 6 volt "C" batteries each made of four little penlight cells connected in series. The heater voltage is taken from the auto battery and is used as a safety precaution. A triple-pole, single-throw switch opens the heater circuit and the plate and bias circuits of the first stage of the amplifier when the unit is not in use. It is not necessary to open the plate circuit of the

(Continued on page 110)

Complete schematic diagram and parts list covering the phototube headlight dimmer.

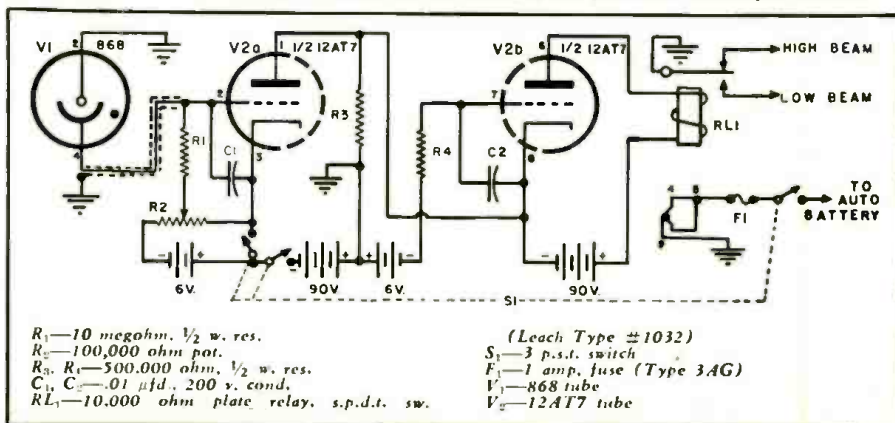

U.H.F.

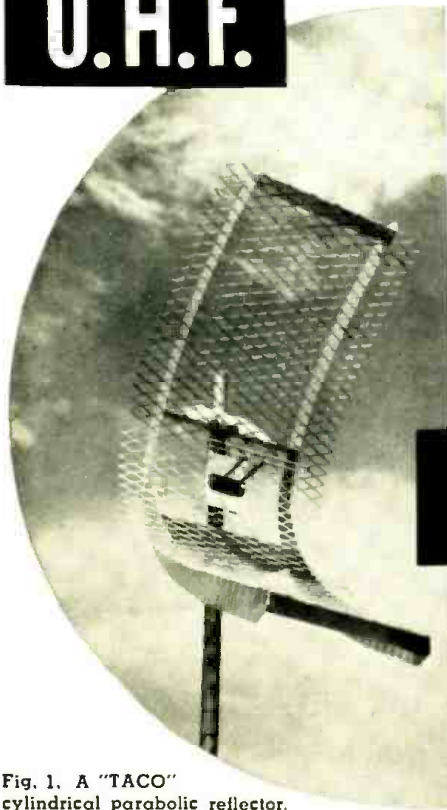

Fig. 1. A "TACO" cylindrical parabolic reflector.

IN THE preceding article we examined in detail such u.h.f. antennas as fan dipoles, stacked "V's," rhombics, yagis, plus other arrays which at present find application at v.h.f. but which can also be employed at u.h.f. with suitable size modifications.

Continuing our study of u.h.f. arrays, let us consider those antennas which owe their sharp directivity and high gain to their reflectors.

The addition of a reflector to an antenna serves several purposes. First, it reduces or substantially eliminates reception of any signals approaching the array from the reflector side. This converts a bi-directional antenna into one which can receive signals from essentially one direction only. Secondly, it increases the gain of the array in the remaining direction.

In v.h.f. applications, there is usually only one reflector employed and this is frequently a single rod, or, at most, two or three rods, positioned about .15 to .25 wavelength behind the receiving element. While these rods do serve to reduce signal reception from the rear, they are far from being totally effective. A more efficient reflector would be one constructed of a solid metallic sheet (or a wire mesh of similar size) placed behind the antenna. At v.h.f. frequencies, antenna dimensions are such that use of a sheet reflector would cause the array to become bulky and frequently difficult to erect. However, at u.h.f. frequencies, the dimensions are sufficiently reduced so that sheet reflectors are entirely feasible. Mesh screens serve as well

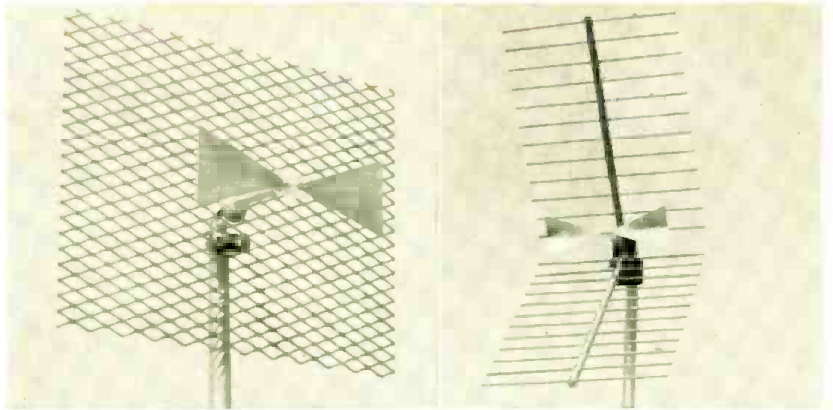

Walsco's "Reflecto-Fan" (left) and "Corner Reflector" (right) antennas for u.h.f. reception. They were recently field-tested in Portland, Oregon.

ANTENNAS

By MILTON S. KIVER
Pres., Television Communications
Institute

*Part 2. An analysis of u.h.f. antennas using reflectors.
Several arrays of unconventional shapes are also covered.*

as solid metallic sheets. The fact that there are openings in the screen does not materially affect its performance as a reflector as long as the openings are on the order of .2 of a wavelength or less. Dimensions of the reflector are not critical but the edges should extend for a short distance beyond the dipole elements.

In common use, too, are parallel bars as reflectors in place of a mesh. The same considerations of small spacing apply here, also.

Two stacked dipoles with a sheet reflector made of a series of rods are shown in Fig. 6. The dipoles in this instance are broader than conventional rods and this is done purposely to extend the bandpass of the array and to keep the input impedance more uniform over the range of frequencies to be received. The antenna shown was designed for v.h.f. use and within this region the reflector screen is 8 feet across. The same array, dimensioned for the u.h.f. band, could be reduced considerably.

Parabolic Reflectors. Parabolic reflectors are not at all new. For many years, before anyone thought of using them for the concentration of radio waves, they were employed for light beams. Their concentrating action is due to the shape of the reflecting surface and the fact that, for reflection, the incident and the reflected rays make equal angles with any line that is drawn perpendicular to the surface at the point of reflection. To understand this, refer to Fig. 3A. Here we have the ray AB hitting the parabolic surface at point A . Let the line NA be perpendicular to the parabola at Point A . Then, for reflection, angle α must equal angle ϕ . It will be found that the reflected ray AC will pass

through the focal point F . Furthermore, it can be shown that all rays parallel to the main axis reaching the parabolic surface will likewise meet at point F . Going the other way, rays starting from F will strike the parabolic surface and travel outward in parallel lines, as in Fig. 3B. Spherical surfaces do not possess this property. The parabolic reflector may be used either to concentrate a set of rays coming toward it or to produce a group of parallel rays for transmission. In ultra-high frequency communication, both are desirable.

It should be noted that the concentrating action or focusing occurs only when the rays arrive at the reflector along lines parallel to its main axis. For all other angles of incidence, the rays do not pass through the focal point F . The reader might think this would impose a limitation on the unit, but experience has shown that radio waves coming from points as close as 3 or 4 miles away arrive essentially as parallel rays. At greater distances the effect is even more positive.

For reception or transmission, the antenna is placed at the focal point, F . In order to achieve the proper focusing action, the antenna must be kept as small as possible. For this reason, only simple antennas are used.

The radiation beam of a parabolic reflector (known also as a rotational parabola or a paraboloid) is circular. See Fig. 5. This means that the height of the beam in the vertical plane is the same as the width of the beam in the horizontal plane. It does not mean, however, that the energy is being radiated to all points about the parabolic reflector. The energy is concentrated into a beam, like the light from a flashlight, and projected in the di-

rection that the reflector is facing.

The ability of a parabolic reflector to concentrate energy into a narrow beam is due to its ability to take the spherical waves which are radiated by a dipole placed at its focus, and convert this energy into a plane wave. (For the purposes of explanation, it is easier to consider many of these antennas from the standpoint of transmission rather than reception. However, whatever is stated for one use is just as true for the other.) Now, energy radiated into space will travel in a direction perpendicular to its wave front. If we have a plane wave, such as shown in Fig. 2A, then the energy will travel forward in a straight line, because this is the only direction which is perpendicular to the wave front. The energy will have no tendency to spread out because all sections of the wave front, being in the same plane, will move forward in the same direction. When the wave front is spherical all sections of the wave front will move in a direction perpendicular to the wave front, similar to the plane wave. However, since the wave front surface is curved, perpendiculars drawn to various points of the wave will not all be parallel to each other. See Fig. 2B. As a result, this energy will spread out as it travels producing a radiation pattern which is not as sharp or directive as that obtained with a parabolic reflector.

As a general rule, then, the directivity of any radiating system depends upon its ability to convert whatever energy it receives into a plane wave.

In order for a parabolic reflector to produce a plane wave, its shape must be truly parabolic in all directions, the antenna must be placed precisely at the focal point, and the dimensions of the antenna made small in comparison to the dimensions of the parabolic "dish." If any of these conditions are not adhered to, the radiation pattern does not remain circular and the radiated wave front begins to curve. This causes the beam width to increase and energy is radiated off to the sides through the establishment of minor lobes. Parabolic reflectors, when carefully constructed, are capable of providing appreciable gains over that obtainable from a simple dipole alone.

It is possible to use sections of a parabolic reflector instead of an entire paraboloid. The cylindrical parabolic reflector shown in Fig. 1 can provide a gain of 8 db over a resonant dipole. The vertical directivity is sharp but the horizontal directivity is somewhat broad. Where high gain is desired and the ghost problem is not serious, this array will produce excellent results. Also, the reduction in size from a full paraboloid permits the unit to be built more economically.

The Corner Reflector. Instead of using curved surfaces as reflectors, it is possible to use two flat surfaces which are so placed as to intersect each other at some angle, forming a corner. This type of reflector, shown in Fig. 4, is known as a "corner reflector"

antenna. The driven element, usually a dipole antenna, is placed at the center of this corner angle and at some distance from the vertex of the angle. Fig. 4 shows the antenna as it is used for the reception of horizontally polarized waves. By turning the system on its side, vertically polarized waves could be received as well. The two reflecting sides may form any angle up to the limiting value of 180°, in which position they become a flat surface.

The response pattern of this array depends not only on the corner angle but also on the distance between the antenna and the vertex of the reflector corner. When this distance is relatively large (large compared to the wavelength used) a pattern containing more than one main lobe is obtained as shown in Fig. 7. Moving the antenna in too close will affect the vertical response of the array and

make it more susceptible to ground reflected signals. Since neither of the foregoing conditions is desirable, the exact positioning of the dipole must be carefully controlled.

The corner angle in the commercial array of Fig. 4 is 90° and a similar bend is placed in the dipole. The reflector bar spacing is 2 of a wavelength or less at the highest frequency at which the array is to be used. Gain over the entire u.h.f.-TV band is high, ranging from about 7 db at 500 mc. to 13 db at 900 mc. The wide bandwidth and good gain of this array make it very attractive for weak signal areas.

Horn Antennas. With the shift of commercial television broadcasting to the ultra-high frequencies, we approach the region where horn antennas, which are so widely employed in radar, become feasible for TV. Here, again, size is the only restricting factor and only in the u.h.f. region do

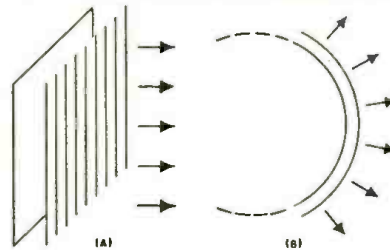

Fig. 2. A plane wave (A) tends to travel in a straight line, maintaining a close concentration of energy. A spherical wave (B) tends to spread out.

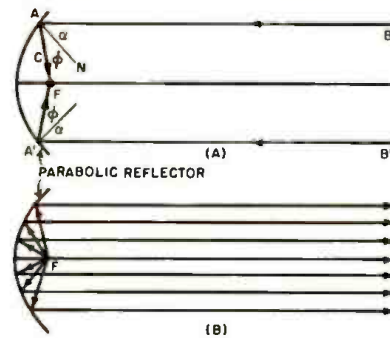

Fig. 3. (A) Action of a parabolic reflector in concentrating all parallel rays at its focus, F. (B) Rays originating at the focal point, F, leave the parabolic surface in parallel rays.

Fig. 6. A v.h.f. array using a reflector screen. Such reflectors are more common in u.h.f. region than v.h.f. band.

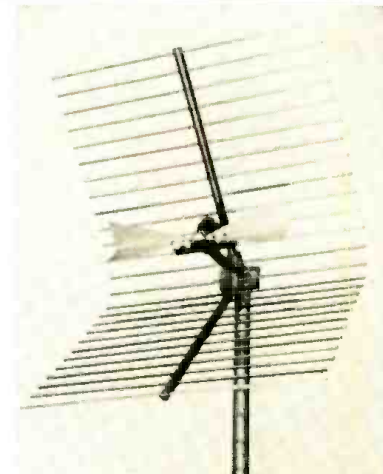
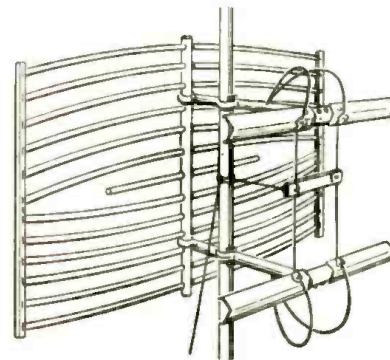
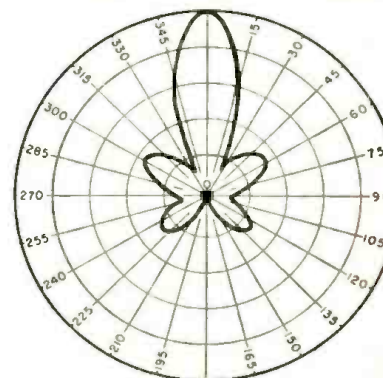

Fig. 4. An RCA corner reflector using a fan dipole. See text for description.



Fig. 5. The radiation beam of a parabolic reflector is circular as shown.

Fig. 7. When distance between the dipole and corner reflector is too large, more than one lobe will appear.



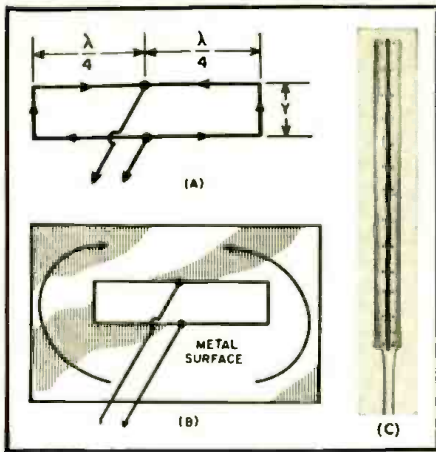

Fig. 8. (A) Two parallel-connected quarter-wave stubs. (B) A simple slot antenna. (C) A commercial slot antenna for u.h.f. TV.

these units become small enough to assume reasonable proportions.

A horn antenna can be considered as an outgrowth of a wave guide. Wave guides are very efficient hollow transmission lines which are extensively employed in ultra-high-frequency circuits to conduct energy from one point to another. If it is desired to transmit this energy into free space, the ends of the wave guide are flared out. See Fig. 10.

By flaring the ends, the energy traveling along the guide will gradually move from the guide to open space with a minimum of reflection back into the wave guide. In a sense, then, the flaring serves as an impedance match between the guide and the sur-

rounding space into which the energy is transmitted. By the same token, any energy which is received is gradually conducted through the narrowing horn until it reaches the wave guide.

Horns and wave guides may either be rectangular or circular in shape. Of immediate interest is the rectangular horn. With several modifications, this can be made into an effective TV antenna. Rectangular horns contain four sides, but since horizontally polarized waves are used in TV transmission, both top and bottom sides of the horn can be removed. Secondly, since transmission lines rather than wave guides are used to conduct the energy from the antenna to the receiver, we can remove the wave guide and substitute the conventional 300-ohm twin-lead. See Fig. 9. Now, all we need do to transform this into a practical device is to use a fine mesh wire screen in place of the two remaining solid metal sides.

From the difference in shape of the modified horn antenna, the reader may suspect that the method of computing its dimensions will also differ from other antennas. For the horn shown in Fig. 9, the height and width (or vertical side separation distance) dimensions are given by the formula:

$$H = W = \frac{1}{2} \lambda_c$$

$$\text{and } B = \frac{1}{2} \lambda_c \text{ (when } \theta = 60^\circ \text{)}$$

where λ_c is the lowest wavelength which it is desired to receive with this

¹ Morgan, D. O.: "Horn Antennas for Television," *Electronics*, October, 1951.
² Kraus, John D.: "Antennas," Published by the McGraw-Hill Book Company, New York.

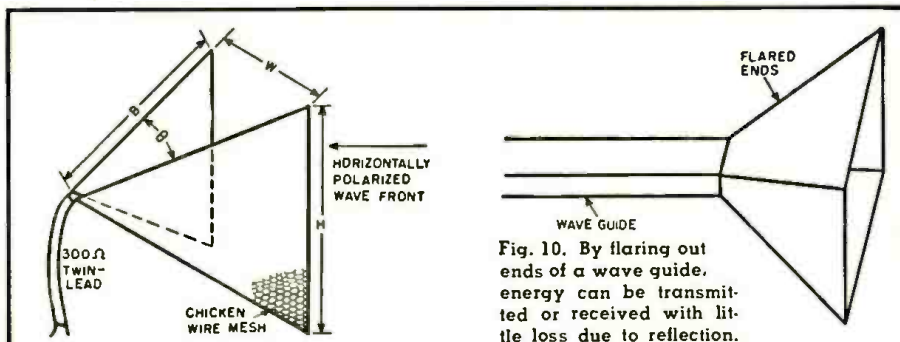

Fig. 9. A horn antenna which is suitable for television reception.

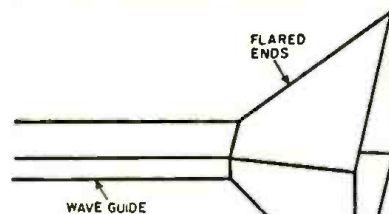

Fig. 10. By flaring out ends of a wave guide, energy can be transmitted or received with little loss due to reflection.

Fig. 12. Response pattern of horn antenna. Note how small back lobes are.

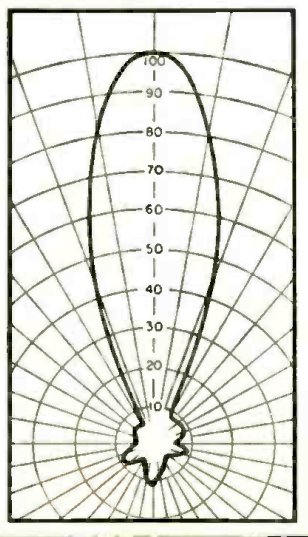
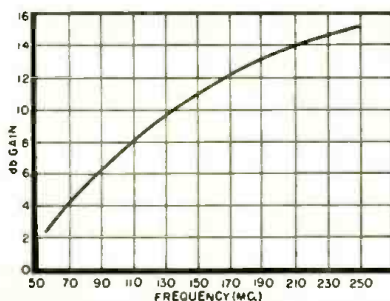

Fig. 11. Gain curve of a horn antenna.



horn. Thus, if the lowest signal to be received is taken as 61 megacycles, $\frac{1}{2} \lambda_c$ is found equal to 8 feet, using the wavelength formula:

$$\lambda = \frac{984}{f(\text{mc.})}$$

$$\lambda = \frac{984}{61}$$

$$\lambda = 16 \text{ ft. approx.}$$

$$\text{and: } \lambda/2 = 8 \text{ ft.}$$

Now, of course, 8 feet represents a considerable height and width across the mouth of the horn in spite of the fact that the two sides taper down to a narrow opening at the transmission line end. However, 61 mc. is a fairly low frequency for which to be using a horn antenna. In the u.h.f. band the dimensions would be reduced considerably, for at 500 mc. they become about 1 foot by 1 foot across the mouth of the horn.

In one 8-foot model¹, the power gain of this horn over a half-wave dipole at 61 mc. was slightly more than 2 db. See Fig. 11. Note, however, how the db figure rises with frequency and at 216 mc. it is greater than 14 db. The gain thus is seen to be considerable and it also possesses the desirable characteristic of rising with frequency. In addition, this array possesses a fairly sharp directive pattern as shown in Fig. 12. Reception of signals from the rear of the structure is on the order of 1 per-cent.

Examination of the gain curve in Fig. 11 reveals how rapidly the gain decreases as the cut-off frequency is approached. This type of behavior is typical of horn type structures and it means that if appreciable gain is desired at a certain frequency and beyond, that the cut-off frequency be chosen well below this point.

The gain of a horn is also dependent upon the flare angle of the horn. This is the angle θ (in Fig. 9) which the horn sides make with each other as they approach the apex where the transmission line is located. Flare angles between 40° and 60° are most common. For each length of a side there is one angle which will give best results. In general, as the length increases, the optimum angle needed becomes smaller. In the 8-foot horn discussed, a 60 degree flare angle was employed. This is a good compromise for the $\frac{1}{2} \lambda$ dimensions given in the formulas.

Other Antennas

It would be difficult to attempt to describe all of the queer shapes and configurations which u.h.f. antennas can take. Already covered are those which will probably be most popular. However, before we leave this subject, it may be of interest to examine briefly several additional antennas which have been used for u.h.f. reception.

A. *Slot Antenna.*² When two resonant quarter-wave stubs are con-

(Continued on page 127)

THE "TWO-METER MASTER"

By **ROB WAGNER, W6WGD**
R.F. Lab. Dalmo-Victor Co.

WORKING two-meter DX with low power seems to be dependent upon several factors: one, a good location; two, an efficient antenna; and three, well designed equipment. Before describing a miniature eight-tube transmitter of broadcast quality which inexpensively fulfills the third requirement, let's compare two hypothetical two-meter stations and their DX logs:

At station Number One, we find its operator chatting away with Far Acres, which location measures two hundred and sixteen airline miles from the operating table. The signal report, umpteen db above S9, is due, in part, to six feet of rack and panel, sufficient in size to house a full gallon on one of the lower bands, running some portion of a kilowatt input on two meters. By comparison with station Number Two, the cost of this electronic machinery is phenomenal.

Operator Number Two has a much smaller version of the foregoing installation; the pleasures of "high" power are denied him, for *THIS* fellow has to buy bread, beans, and baby shoes. His interest lies in obtaining the most power output from the least dollar input, applying thereto audio sidebands of sufficient magnitude to be heard in DX-land with good readability. His signal report at Far Acres sounds less than umpteen db over S9, but his QSO "Enjoyability Quotient" seems just as high as that of station Number One, while his saving in beans and baby shoes is considerable. The higher input may result in more consistent DX averages, but Two maintains a fairly good score considering the difference in light bills.

For those who fall into the "Number Two" category, the following transmitter should be of interest.

The r.f. section uses an 8 mc. crystal, a pair of 5763's and an 832A to arrive at 144 mc.; a second 832A functions as the class C final, operating at 18 to 21 watts input. A single 12AU7 delivering class B modulation, 12AT7 cathode-follower driver, 12AT7 amplifier, and a 12AX7 cascaded for two stages of speech amplification comprise the miniature modulator. Designed for use with a crystal mike, the quantity and quality of available audio will elicit bouquets from those claiming a hi-fi ear!

During the course of this article, emphasis has been placed upon grid-drive, that elusive quantity so often found lacking in two-meter transmit-

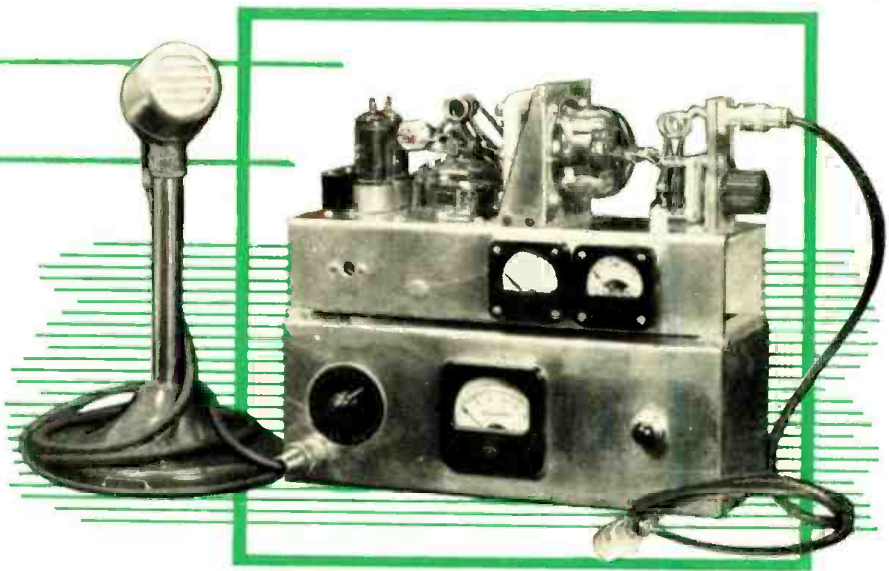

Fig. 1. Over-all view of the compact two meter transmitter.

Good efficiency, hi-fi audio, and compact size are features of this low-power 144 mc. transmitter for ham and CD use.

ters. Without adequate drive, modulation linearity is non-existent, anodes tend to become illuminated, while efficiency drops to the point of no return.

After several types of circuits were tried, the "Two-Meter Master" evolved into its present design, one which has shown its merit by delivering maximum miles per dollar input.

The r.f. section begins with an electron-coupled crystal oscillator using a 5763 pentode with output at 16 mc. A dual-triode overtone oscillator was tried and rejected, as its 24 and 72 mc. frequencies proved incompatible with certain TV receivers. (Secondly, its power output was found to be too

little to provide the "more than just enough" grid drive required in all stages of the transmitter.)

The schematic diagram, Fig. 3, shows an 8 mc. crystal in a modified Pierce circuit, employing the screen grid of the 5763 as the anode of a triode oscillator. The electron-coupled plate circuit tunes to the crystal's second harmonic by means of L_1 , a miniature iron-slug tuned coil, through which flows 300 volts of d.c. plate potential.

A 5763 pentode operating as the first tripler to 48 mc. receives approximately three milliamperes of grid drive by means of its capacity coupling

Fig. 2. Bottom view of unit showing modulator wiring. Tube sockets and driver transformer mount on the aluminum breadboard, inverted to show wiring technique. Breadboard connections are made through flexible cable of sufficient length to allow removal of unit for easy maintenance. Note the shielded wires running from speech input terminals to microphone connector and gain control, shown mounted on rear of front panel. Power input plug is mounted at extreme left end of case.



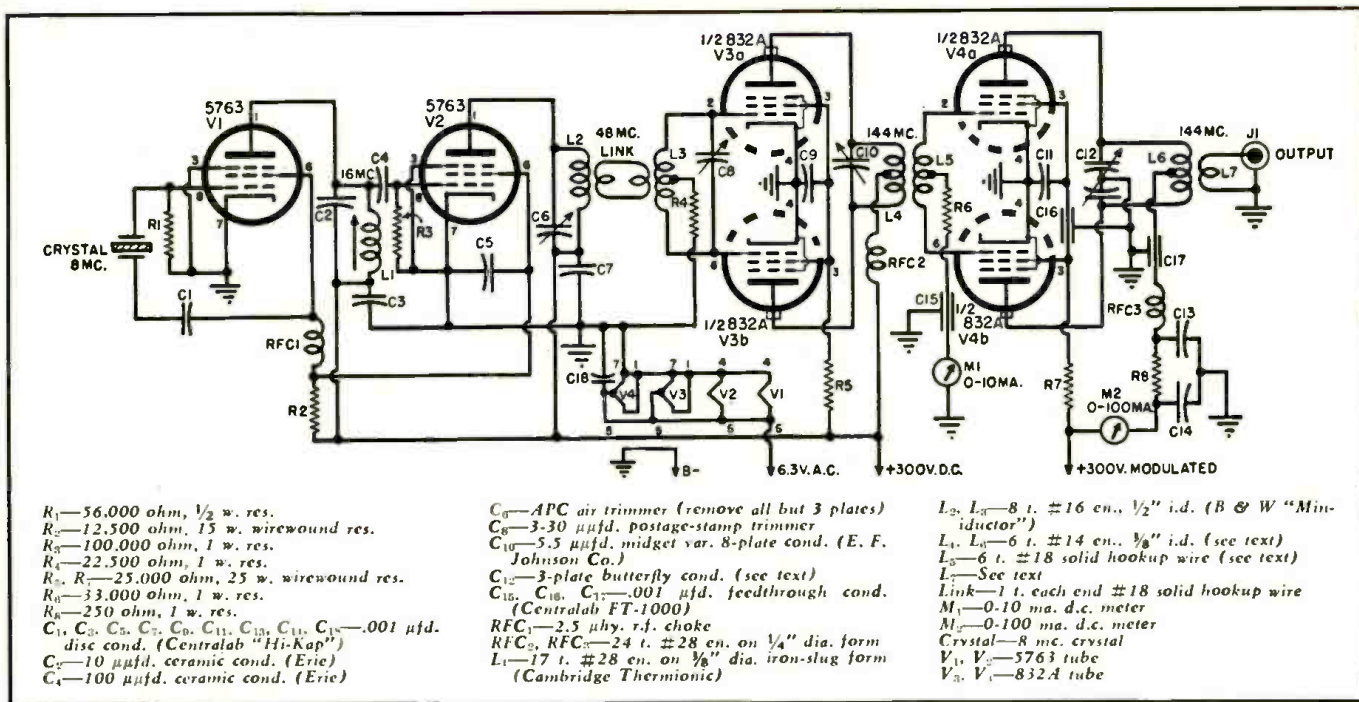

Fig. 3. Schematic diagram of the r.f. section of the 144 mc. transmitter. See Fig. 7 for the modulator schematic.

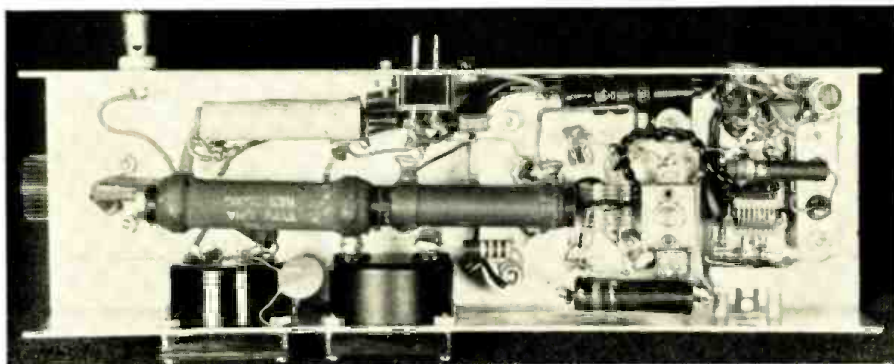
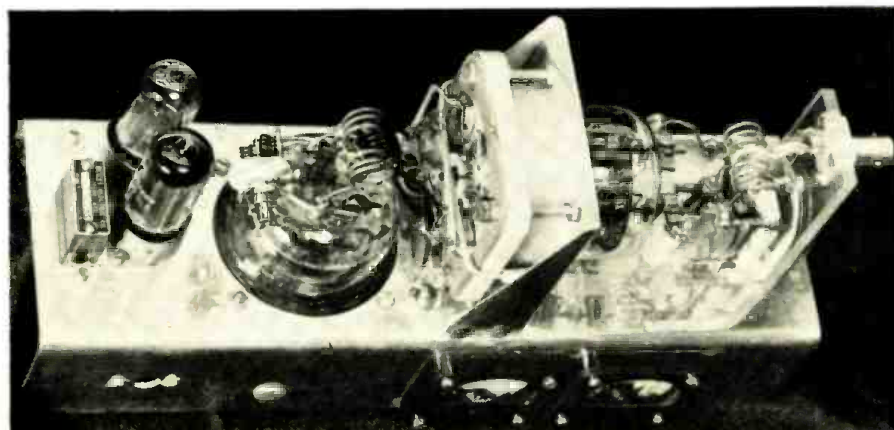

Fig. 4. Bottom view of r.f. unit. The crystal socket, with oscillator plate coil L_1 above, is at the extreme right. C_6 , the APC air padder with L_2 mounted across its terminals, appears at bottom right. C_5 and L_3 are shown mounted on tube socket, which also supports the oscillator r.f. choke, RFC_1 . Screen resistors R_6 and R_7 are bolted together, supported by connections to the power plug and tube socket. R_2 mounts with a bracket adjacent to the power plug. Note home-made meter shunts.

Fig. 5. Top view of the r.f. unit. The 5763 oscillator tube appears top left, with the 5763 first tripler following the crystal. C_{10} and L_4 , the plug-in tank circuit, is shown coupled to L_5 , the final amplifier grid coil. The amplifier's neutralizing wires are visible across the back of tube socket. The final amplifier plate circuit, shown with antenna link fully coupled, is clearly shown, including the method of connection to the 832A plate terminals. Oscillator output is tuned with the slug screw, visible above the crystal at the extreme top left. Screwdriver setting of C_6 , the 48 mc. plate condenser, is made through small hole on left front panel.



(C) to the oscillator plate coil. The tripler plate circuit tunes with C_6 , an APC air trimmer cut down to three plates, and L_2 , an eight-turn B & W "Miniductor" soldered directly to C_6 . Mounting of components is shown in Fig. 4. R_3 provides grid bias, and 250 volts of screen potential comes from the junction of RFC_1 and R_2 at the oscillator screen supply point. The 48 mc. 5763, operating at a plate potential of 300-325 volts, supplies 2.5 ma. of grid drive to the following stage.

5763's were chosen for the first two stages because of their excellent frequency-multiplying characteristics and power handling capabilities; the second tripler utilizes an 832A for several other reasons. The tube, one of the few available which makes an effective push-pull tripler to the v.h.f. spectrum, operates efficiently with a minimum of grid drive, providing sufficient output without running to incandescence of both anodes and pocketbook. Use of the 832A, operating well under its maximum ratings (rather than smaller tubes dissipating their maximum power), has proved its worth during many long rag-chews. Remember—a locomotive can't be pulled by a team of white mice, even though the driver uses a big whip!

The second tripler link-couples to its driver stage to afford selectivity against harmonics (watch that TVI!) and optimum coupling, resulting in a better power transfer than was forthcoming from capacity coupling. (NOT recommended!) Unity coupling could not be used at this stage due to physical placement of components. To conserve space, the 832A grid circuit resonates with C_8 , a "garden-variety" postage stamp trimmer, and a B & W "Miniductor" (L_3) of eight turns soldered directly to the socket's grid

pins. A twisted length of solid insulated hookup wire provides link coupling between both triplers. A one turn link to the plate circuit of the first tripler fits snugly inside the "cold" end of L_2 , while the link's opposite end forms a single turn around the outside center of the 832A grid coil, L_3 . Details are shown in Fig. 4.

Connected between the center of L_2 and ground, R_1 provides grid bias for the 832A; the use of an alternate circuit requiring separate bias resistors to avoid center tapping the coil proved unnecessary. Voltage dropping resistor R_2 from the 300 volt plate supply delivers screen potential to the tube, which measures approximately 250 volts d.c.

The second tripler's tank circuit appears somewhat unusual. A small inductance (L_4) and tuning condenser (C_{10}), soldered to a pair of miniature *Fahnestock* clips, serve to "plug on" the tank circuit atop the tube at its plate connectors. This not only conserves space, but results in the shortest leads at this point. In addition, it places the tripler plate tank immediately adjacent to the final amplifier's grid connections at the tube socket. Note the tank condenser, C_{10} , is a midget air padder having eight plates (approximately 5.5 μfd . capacity). An air condenser is recommended rather than postage-stamp or rotary ceramic trimmers, since the 832A attains a high operating temperature at its top, resulting in frequency drift if a temperature-sensitive condenser is used.

The 832A final amplifier receives its drive from the second tripler plate coil by means of unity coupling. Capacity and link coupling were tried but were discarded in favor of this method, as unity coupling offers an optimum impedance match between circuits and provides maximum grid drive to the final. Unity coupling requires no re-tuning when changing frequency, being broadly resonant by virtue of its relatively high impedance at 144 mc. This coupling must be carefully adjusted during tuneup; maximum coupling does *not* mean maximum drive! L_5 , six turns of insulated solid hookup wire, solders directly to the grid pins of the final amplifier's tube socket. The grid coil interlaces about half way into the turns of L_5 , and a point of mutual inductance will be found where maximum drive occurs. Approximately four milliamperes of drive appears at the final grid meter, more than is required for the 832A operating under these conditions. However, in this case subtraction is preferable to addition, thus reduction of drive to its proper value of 2.4 ma. may be accomplished by slight decoupling of L_5 .

The final amplifier plate circuit differs from the preceding stages, being tuned with a balanced split-stator condenser, C_{12} . For maximum efficiency, long lines should have been used, but space would not allow. The amount of plate efficiency sacrificed by employing a tank circuit appears to be

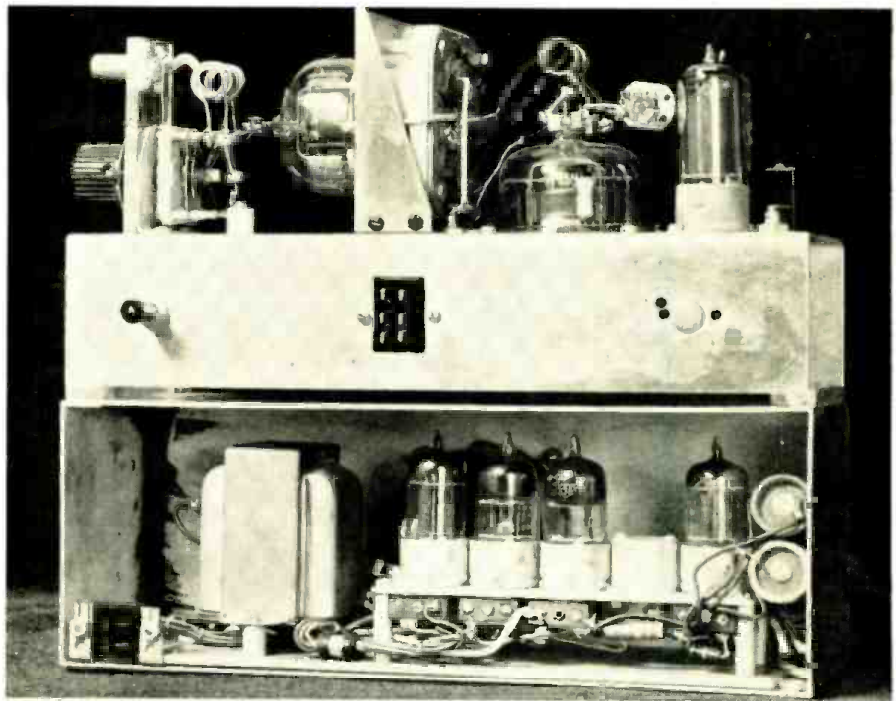

Fig. 6. Rear view showing modulator construction. The 12AX7 speech amplifier tube, with C_1 and C_2 decoupling condensers, appears at the far right. From the "Ouncer" transformer straight left to the 10-watt modulation transformer, assembly follows schematic layout. The binding post terminal "A" provides separate power input from the modulator to final amplifier. Power cables, etc., are omitted to insure clarity.

negligible in view of the satisfactory amounts of DX worked, in addition to having utilized a minimum of space in construction.

The final tank condenser, C_{12} , evolved from a junk-box (SCR-522) butterfly condenser with all but two rotors and one stator plate removed to lower the capacity to approximately 15 μfd . Both L_5 and L_6 are wound with 6 turns of #14 wire upon the shank of a $\frac{3}{8}$ "

drill, leaving a $\frac{1}{4}$ " space at each coil's center. This construction facilitates center-tapping, also allowing insertion of the single-turn antenna link at the coil's center. C_{12} provides mounting for a rectangular piece of polystyrene which supports a miniature coax connector. A single-turn antenna link fastens to the connector, providing r.f. output to a coaxially-linked antenna coupler. (Continued on page 143)

Fig. 7. Complete schematic of the modulator unit. See Fig. 3 for r.f. section.

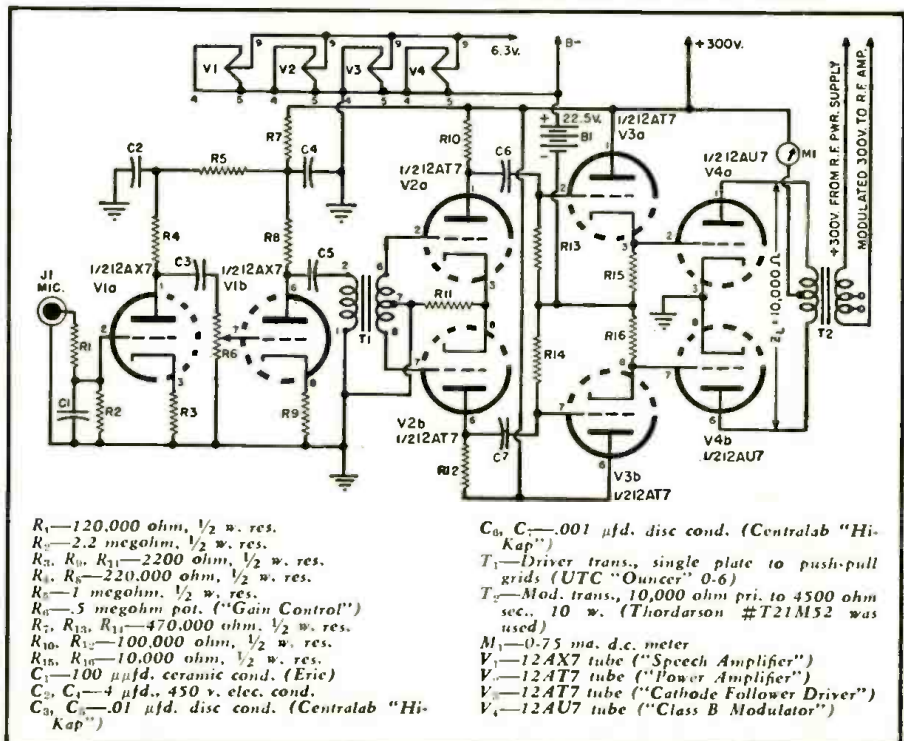

DEMAGNETIZER

By

MATTHEW MANDL

Author, "Mandl's Television Servicing"



Fig. 1. Plastic reels of recorded tape can be demagnetized in a single operation by using unit described in this article.

Details on a handy service tool which can be built from junk parts and used for various demagnetizing procedures.

A HANDY device around the service shop is a unit which can produce an a.c. magnetic field. This is useful on those occasions when it is necessary to demagnetize metal-sided picture tubes, tape recorder heads, and for other applications involving either a magnetizing or demagnetizing process.

One of the simplest means for constructing such a unit is to utilize an old power transformer, as this eliminates the necessity for coil winding. All the laminations are first removed as shown in Fig. 3. Make sure the power transformer has no internal shorts by checking with an ohmmeter. If some of the low voltage secondary windings are damaged, these can be unwound after lamination removal. The flat long sections are discarded, while the E-shaped sections are reinserted in the core in one direction as shown in Fig. 4A. The transformer cannot be used in that form, however, because the loose laminations will buzz and vibrate severely upon the application of a.c. to the primary of the transformer. (If long leads extend from the secondary windings, they should be cut off flush with the core.)

The unit can be placed in a wooden box or tin can as shown in Fig. 2 so that the open end of the unit is flush with the top of the wooden or tin container. A hole can be drilled in the closed end to accommodate the a.c. leads. Sealing wax can then be melted

over a slow heat and poured over the transformer. Pour the sealing wax until it rises to the level of the transformer core top. Excess can be trimmed off with a hot knife. The unit should then be set aside to cool.

A wooden section or a disc cut from a plastic sheet can be mounted on the closed end with stand-off tubular supports. A push-button is used so the current to the primary winding can be turned on and off at will. (See Fig. 1.)

The container can be painted any color to suit, and a section of felt should be cemented to the exposed sealing wax using *Miracle* cement or other similar adhesive. The felt is necessary to prevent chatter which is set up by the magnetic field when the unit is brought near the object.

Fig. 2. Over-all view of the demagnetizer. It is constructed from junk box parts.

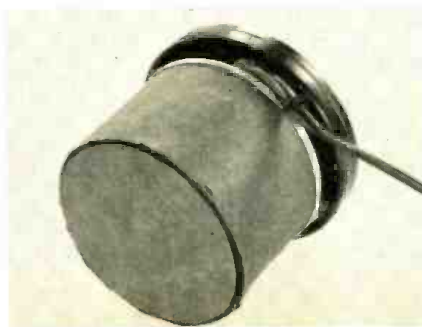

After the switch has been wired to one of the leads of the transformer primary, a line cord is attached for six feet or more, depending on how far away from the a.c. plug the unit is to be used. Fig. 4B shows the schematic of the completed unit.

Typical Uses

Demagnetizing Metal Picture Tubes: If the metal side of a picture tube has been brought into contact with a permanent magnet, a portion of the metal will retain magnetism and influence the picture beam. As the picture beam travels through the tube it is bent out of its true path by the field produced by the magnetized portion. Thus, during the sweep of the beam its linearity will be affected each time it comes into the area of the magnetic field. Thus, one corner or portion of the picture can become severely distorted by the presence of the magnetized portion of the picture tube as shown in Fig. 5. This distortion will be present at all times and cannot be eliminated by adjustments of the linearity or other controls. (This is different from the corner shadow effect produced when the electron beam strikes the neck of the picture tube internally. In such an instance a portion of the picture is blotted out, while with a magnetized cone the entire picture is present but bent out of shape in one section.)

The demagnetizer can be used to remove the magnetism lodged in one section of the picture tube by use of the magnetic field produced. Inasmuch as the a.c. field generated is very strong, however, several precautions must be observed. Do not, for instance, depress the button and then bring the demagnetizer near the metal side. The force of the magnetic pull will be so strong that the demagnetizer will be drawn abruptly to the side of the picture tube with a severe jar. Instead, place the unit over the portion of the picture tube which is magnetized and depress the button while the felt end of the demagnetizer is resting against the tube side as illustrated in Fig. 4C. With the button depressed, the demagnetizer is moved in a rotary fashion around the suspected area and then removed *while the switch is still closed.*

As with the precautions mentioned later for demagnetizing recording heads, care must be taken not to release the switch while the magnetic

field is influencing the metal side of the picture tube. If the switch is released, the collapsing field will severely magnetize the picture tube side instead of demagnetizing it. Make sure the switch is depressed and remove the unit beyond the point where its field influences the picture tube. Recheck by turning the receiver on to see if the distortion is present. Make sure that improperly adjusted linearity controls or corner shadows are not giving symptoms of magnetism.

If the area has not been freed of magnetism, the a.c. field can be re-applied and the entire unit moved all around the tube to make sure all areas are demagnetized. Keep the button depressed and remove the unit with the switch closed. If desired, a small pocket compass can be used initially to determine the exact whereabouts of the magnetized portion.

Erasing-Recording Heads: After a tape recorder has been used for a while the recording and erasing heads have a tendency to become magnetized. This decreases the efficiency of recording and introduces some element of distortion in the recorded sound. For this reason it is good practice to subject both the recording and erase heads to an a.c. field to obliterate the magnetism which they have accumulated. This, of course, does not apply to permanent magnet erase heads.

To do this, remove the tape reel from the machine because if the reel has recorded information, portions of it will be erased by the presence of the magnetic field of the demagnetizer. After the reel has been removed from the machine the demagnetizer is brought near the recording and erase heads and the button depressed. Bring the demagnetizer as close as possible to the recording and the erase heads. Leave the unit in position for a few seconds and remove *while the button is depressed*. If the button is released while the unit is close to the recording and erasing heads, it will magnetize rather than demagnetize them. For this reason it is essential that the a.c. magnetic field be maintained by keeping the button depressed while moving the demagnetizer a couple of feet away from the heads.

Erasing Magnetic Recording Tape: The erase heads of tape recorders are often unable to cleanly obliterate over-modulated recordings. On playback the old recording is then heard faintly through the new recording. To avoid this, the demagnetizer can be used to erase the entire reel of tape at one time. To do this the reel of tape is removed from the machine and placed on a wooden bench. The magnetizer unit is then placed on the reel and the button is pressed to generate the magnetic field. The demagnetizer unit is then moved in a circular fashion all around the reel. With the button depressed the reel is turned over and also treated on the reverse side. The reel is then ready for re-use with complete erasure. Because this is an a.c.

field, the erasure is clean and does not leave a noise background such as is produced when using a magnet. To assure a.c. erasure the button should be kept depressed *while the unit is taken away from the reel*. Alternating current signal energy in the form of hum will not be induced into the reel because it is not applied while the tape is moving through a recording head. Instead, the a.c. field is applied over the entire surface area at one time for erasure purposes.

The button should not be kept in a depressed condition for more than several minutes, because the absence of the rectangular small lamination sections has decreased the core area of the transformer. This decreases permeability and has the same effect as reducing inductance. For this reason the inductive reactance (opposition to a.c. flow) has been reduced and greater currents flow than would normally be the case. For this reason the core and laminations will start to heat up after a few minutes and may melt the sealing wax. However, as only a few seconds are required for erasure, there is no necessity for keeping the button depressed for extended periods.

The unit is effective on tape which is on a plastic reel. When tape is on a metal reel the metal ribs act as a shield for the magnetic field and partial erasure results. Also when the coil is brought into proximity to a metal reel, severe vibrations and chatter will be set up in the metal sides of the reel.

The reels should not be demagnetized while on the machine, because the metal panel will influence the erasure and clean erasure may not result.

Magnetizing Servicing Tools: Screwdrivers, pliers, scissors, or other tools can be magnetized by this unit. A strong magnetism is induced in such objects by the fields generated by this device. In order to magnetize a screwdriver or other object, hold it against the felt face of the unit as shown in Fig. 6. Depress the switch for a few seconds and release the switch *while the tool is held to the unit*. Inasmuch as the collapsing magnetic field which is produced when the button is released is of a single polarity, it will magnetize any metal tool capable of receiving magnetism.

Demagnetizing Tools: If the occa-

Fig. 5. Effect of magnetization on television pattern. Picture is distorted in the tube area which has been magnetized.

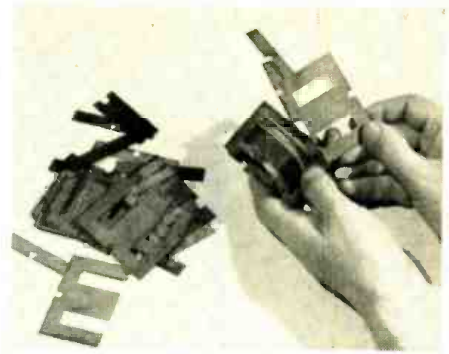

Fig. 3. Disassembling the transformer used with unit. The "E" sections are retained.

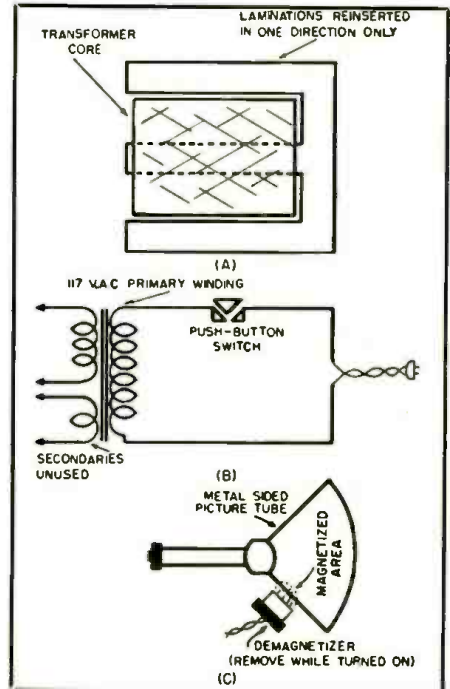

Fig. 4. (A) Correct method for re-assembling transformer. See text. (B) Complete circuit diagram for demagnetizer. (C) Method of using unit on metal-sided picture tube.

sion should arise where a tool or other metal object is to be demagnetized it should be held to the face of the unit and the button depressed, and *removed while the switch is still in a depressed condition*. While the switch is closed, the field generated is a.c. in character. During this field, the object is removed from its influence and for this reason it will be rid of any residual magnetism which it contained. -30-

Fig. 6. How the demagnetizer can be used to magnetize service tools. A slight variation in operation permits this function.



AN AMPLIFIER FOR

\$20.

By **ARNOLD J. GASSAN**

Construction details on a quality amplifier unit which is designed for those with a good ear but a flat purse.

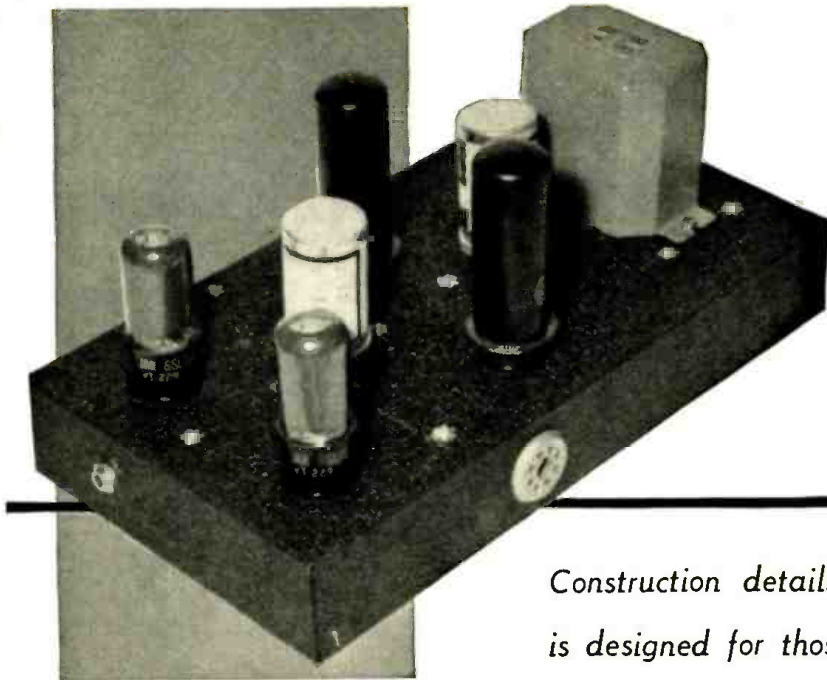

Fig. 1. Front view of the home-built amplifier. Parts required for its construction can be obtained for less than twenty dollars.

SEVERAL times friends have asked me to build them an amplifier that sounded "good." When asked why they didn't buy one of the commercially available models, they quoted prices from the numerous brochures they had examined, and their plight was clear. An amplifier purchased across the counter will cost from forty dollars up, and there will be no guarantee of anything more than that the thing will make sounds.

The "hi-fi" enthusiast apparently has to have either a well-lined pocket-book or a tin ear. Somewhere between these limits is a tolerable average of cost against fidelity; the amplifier described is one answer. Essentially, it is a compound of several amplifiers, all of which are excellent, but the commercial models have prices beyond the purses of the average music-lover with a yen for better sound than his conventional table radio-phono combination will produce.

The amplifier is one which sounds well. All graphs aside, that is the final criterion for an audio amplifier; it must reproduce music or speech with a certain fidelity, allowing the individual character of the sounds to be heard. The design of this circuit has been thoroughly checked with an audio oscillator, harmonic analyzer, and square-wave generator, and the results may be seen in Fig. 4 and Table 1. As in all electronics the final circuit is a compromise, in this case between cost and quality of reproduction. The response curve could easily have been extended to 100 kc., by quadrupling the price of the output transformer. Yet, when this amplifier was "auditioned" with three commercially-available amplifiers in the \$50.00 to \$100.00 range, its performance com-

pared favorably. Essentially, the circuitry is similar to the well known Williamson amplifier.

The Inverter

Starting at the beginning of the circuit, the inverter is a direct-coupled, split-load type, otherwise known as the cathodyne phase inverter.¹ There are two principal advantages to this circuit: first, fidelity. In the general circuit shown in Fig. 2A, a portion of the voltage generated by V_1 is tapped off the voltage divider R_1, R_2 and applied to the grid of V_2 . This circuit is a commonly used type of inverter. In theory, only enough of the signal from V_1 is fed to the grid of V_2 to produce exactly the same signal amplitude at the plate of V_2 as exists at the plate of V_1 , and of course 180 degrees out-of-phase with the plate signal of V_1 . Unfortunately, the balance of output signals from this type of inverter will change each time the tubes V_1 or V_2 are changed. Because of the possibility of the two tubes being changed in opposite directions, i.e., V_1 being replaced with a tube of higher gain than

the original, and V_2 with a lower gain tube, a difference in amplitude of several per-cent can occur.

Just as important is that the RC circuit, $C_1, R_1 + R_2, C_2, R_3$, provides what is essentially a two-stage, high-pass RC filter, with the output of the first stage going to one-half of the push-pull circuit, and the output of the second stage to the other half of the push-pull circuit. The lower the frequencies involved, the more noticeable the phase shift distortion produced by the characteristic. If a feedback loop around the inverter is employed, then at some frequency the out-of-phase components add algebraically to produce more distortion than linearity and, in extreme cases, instability of the entire loop. The second advantage of the split-load inverter over the type just discussed is that it is cheaper. A quick look at Fig. 3 will show that several resistors and a condenser which are indispensable to the older circuit, are not needed.

In the inverter used in this amplifier (see Fig. 3) the effect of direct coupling appears: there are no RC circuits to introduce phase shift, and thus the response of the inverter itself is flat over a tremendous range. The advantages of the unbypassed cathode in the second half of the inverter are evident if one thinks of an unbypassed cathode load as a generator developing a degenerative signal and applying it to a control element of the tube. Thus, the split-load inverter may be looked upon as a conventional amplifier stage with large degeneration, and also as a cathode-follower amplifier. A mathematical analysis of the circuit indicates that the response of either output—the cathode load or plate load—is essentially linear within the limits of the tube itself, and flat well into the megacycles. There is only a small phase shift within the

Fig. 2. (A) Circuit of a feedback-type inverter. (B) The equivalent circuit of the voltage divider in the feedback path.

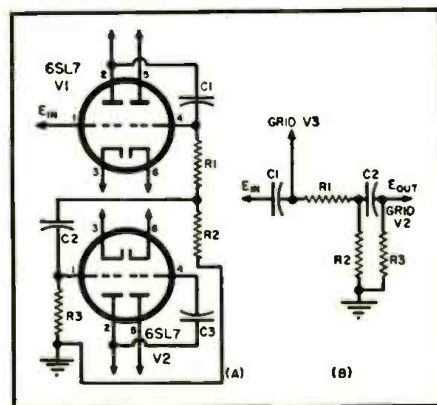

inverter, approaching three or four degrees.

The cathode load was chosen in the output side of the inverter by inserting a variable resistor in the cathode circuit, and determining what actual resistance would develop an equal signal, when compared to the plate signal. The ratio of plate to cathode loads is dependent, it was found, on the value of the plate load of the first half of the inverter and the gain of the tube itself.

The second tube, V_2 , is used to drive the 6L6's, and also for the normal purpose of voltage amplification, since the inverter has little gain, on the order of three or four, for both halves of the tube.

At this point note must be made of the decoupling of all stages. This is expensive, but if not done will cause oscillation; at worst, lack of sufficient decoupling will cause muddiness.

The Output Stage

In many ways the output stage is the most interesting, and certainly more nearly accounts for the sound of the system than any other individual stage. The 6L6 plates are connected normally to the 6000-ohm taps on the output transformer. Then, the screens are connected to the 3000-ohm winding. For d.c., the stage is essentially triode connected, push-pull. Yet, for a dynamic condition, with which we are really concerned, the circuit is a hybrid, with the advantages of both triode connection and tetrode operation, and few of the disadvantages of both.

The effect produced when the screens of a beam-power tetrode are tied to the plates through a closely-coupled tertiary winding of lower impedance than the plate circuit has been analyzed in another publication.² However, in essence, as the ratio of screen to plate impedance moves from zero toward one, the internal impedance of the generator, in this case the 6L6's, falls sharply, then gradually, until it approaches the low impedance of a triode. Under the same conditions the maximum power output available for a constant input power (in other words, the efficiency of the circuit) decreases gradually, along a gentle curve. Low-level distortion decreases rapidly at first, and then gradually; high level distortion increases asymptotically. When a ratio of screen to plate impedance of 18.5% is reached the optimum congruence of the curves results. All these figures and curves are for a closely-coupled third winding, *i.e.*, one coincident with the plate winding? They do, and the end result was that taps were simply placed on the plate winding to produce an impedance ratio that agreed with the computations. The result is that the tubes are operated essentially as triodes looking at the d.c. characteristics, but as tetrodes from an a.c. viewpoint.

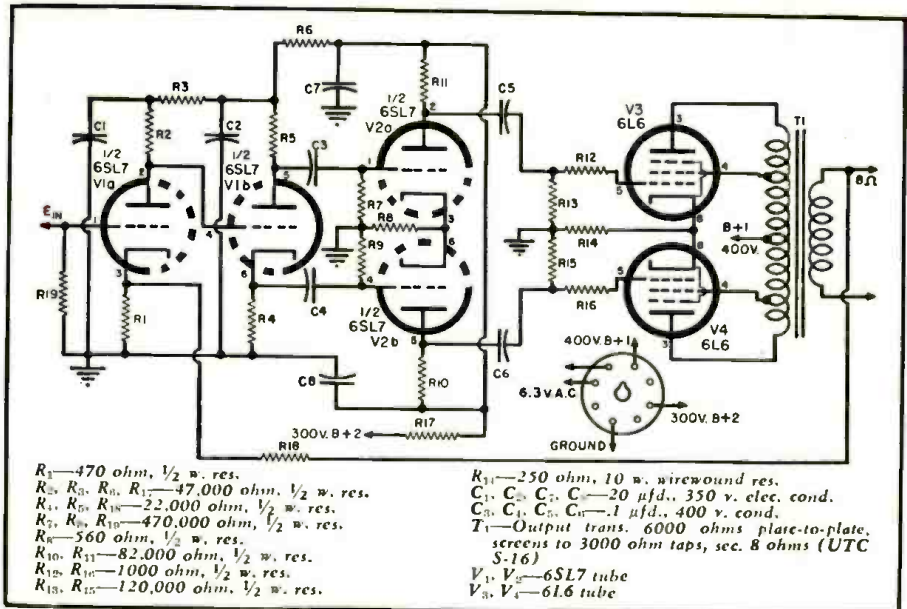

Fig. 3. Complete circuit diagram and parts list for the low-cost amplifier unit.

However, there were no transformers available with taps at 20% of the plate impedance. Experiments were made with ordinary, available, inexpensive transformers with several taps of varying impedance. The lowest impedance ratio available was $\frac{1}{2}$, or 50%; little or no change in the sound was expected with this ratio, because the optimum conditions listed previously are found only in a narrow region of load ratios. Yet, on connecting the screen grids to the available primary taps, an immediate improvement in sound quality was noted. For example, the pitch and timber of tympani were more readily heard and stringed-instruments sounded *cleaner*. The end result is that the circuit has not been modified since being built and tested, which for an audio-electronics hobbyist is most unusual.

A note on the feedback loop: negative feedback is applied to the cathode load of the first stage from the output winding. The concepts behind the use of negative-feedback circuits have often been discussed in this magazine.

(Continued on page 104)

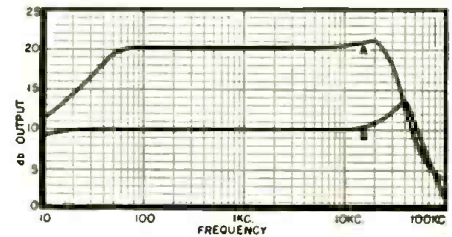
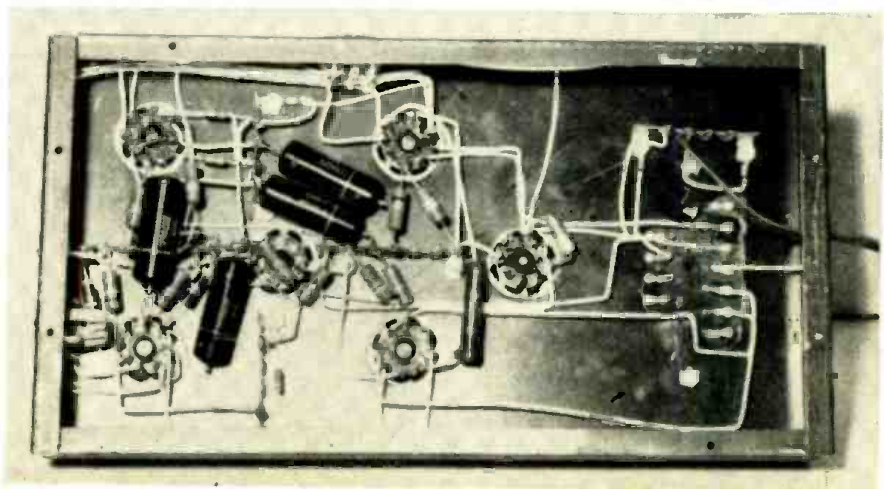

Fig. 4. Output power vs. frequency measured across 8-ohm resistive load. Curve A is .65 volt input, output power of 14.6 watts; Curve B is .20 volt input, output power of 1.25 watts. Db reference level is arbitrary.

Input Volts	Freq.	2nd Har.	3rd Har.	4th Har.
.2	500	.48%	.30%	.13%
.6	500	.84%	1.6%	.20%
.2	1000	.36%	.25%	—
.6	1000	.84%	1.5%	.20%
.2	5000	.37%
.6	5000	.90%

Table 1. Distortion vs. input power-frequency. Percentage of second, third, and fourth harmonics developed at two power levels and at 500, 1000, and 5000 cycles, measured across an 8-ohm resistive load. Signal generator used developed between .1% and .2% combined second and third harmonics.

Fig. 5. Under chassis view of the home-built amplifier showing layout of parts.



however, the entire operation of phase detection and error voltage generation is accomplished by a single triode section of a 6SN7. Note first that this tube receives no "B plus" voltage. The plate is grounded through R_1 and the cathode through R_2 . Incoming sync pulses are applied directly to the grid and cathode while a saw-tooth voltage from the flyback transformer is fed to the plate. Depending on the coincidence of the voltage at the plate, grid, and cathode, the tube will pass more or less current. All tube current must go through R_1 and R_2 and the voltage set up across these two resistors is the error voltage which corrects the frequency of the oscillator. To make sure that this is pure d.c., the filter consisting of R_3 , C_3 , and C_4 is used. An additional signal is fed back through C_2 . This is a small portion of the output of the horizontal sweep oscillator and is connected to the grid of the phase detector. Its polarity is opposite to that of the sync pulse coming through C_2 and it effectively bucks out a portion of that pulse as long as the oscillator is at the correct frequency. When the oscillator drifts, the sync pulse alone becomes effective and helps set up the error voltage to correct the oscillator.

The main advantage of this circuit is its economy. Using one half of a 6SN7 permits the use of the other half in some other section and thus often results in a saving on the number of tubes. Performance of the triode phase detector is no better than its double-diode predecessor, but neither does it result in any disadvantages. It is safe to predict that in many future models the double-diode circuit will be replaced by the triode phase detector and understanding its operation is therefore important to every service technician.

40 mc. I.F.

Like the lifting of the TV station freeze, 40 mc. i.f. systems have been predicted and planned for years. Much has been written about the theoretical and practical advantages of using this frequency. Two valid reasons exist now for changing to a 40 mc. i.f. system. One is the fact that the FCC has now allotted a band at 21 mc. for amateur use, and the second is the appearance of u.h.f. television stations. Probably the most pressing reason is the amateur interference problem and the problem of image interference in some TV areas. Changing to 40 mc. prevents all image reception in any one TV band and naturally greatly reduces the chances for ham interference. As concerns u.h.f., the problems of r.f. bandwidth and a suitable system for tuning the r.f. stages make a 40 mc. i.f. imperative. It permits the u.h.f. tuner to have a 20 mc. passband without any danger of image interference.

The actual frequencies used in the new i.f. band vary slightly, but the standard appears to be 41.25 mc. for the accompanying sound carrier and

45.75 for the video carrier. A typical i.f. passband is shown in Fig. 4. Among the 1953 models featuring 40 mc. i.f.'s are *Arvin*, *Emerson*, *G-E*, *DuMont*, *Philco*, *Westinghouse*, and *Zenith* receivers. The tubes used are usually 6CB6's having a higher transconductance and less loading effect than the old 6AG5 at 40 mc. The loading resistors for stagger-tuned, single-coil systems are slightly higher than in 20 mc. i.f. systems because the tube input loading at 40 mc. naturally is greater than at 20 mc. Traps for the sound, adjacent sound, and picture carriers are mostly of the absorption type used in the older i.f. systems. From these factors it becomes apparent that alignment of the new, 40 mc. i.f. section will present no new or different problems.

Unique Designs

Although most manufacturers advertise some distinguishing feature, space permits us to describe only three of the most unique designs. One unusual design is the *Emerson* model 721, 17" table model featuring recessed controls at one side as shown in Fig. 1. By this mechanical arrangement it is possible to use a really compact design so that the entire receiver is only slightly larger than the picture tube. Because of the recess of the controls the channel selector uses a dial light so that the station number is clearly visible from a reasonable distance. Using a double-tuned 40 mc. i.f., improved intercarrier sound, cascade tuner, and autotransformer type flyback, this receiver is typical of the new 1953 models.

Another unique feature is used in the *Zenith* 1953 models and this consists of a 6BE6 in an unusual sync pulse clipper circuit. This pentagrid tube is the only sync tube in the set and furnishes horizontal and vertical pulses stripped from the video signal and properly clipped and limited. The actual circuit operation is somewhat involved but the principle of it is the use of two out-of-phase signals applied to the control and the converter grid

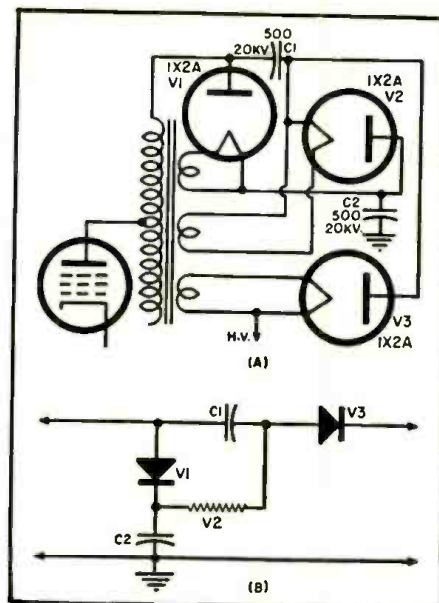

Fig. 3. HV doubler using a diode as HV resistance. (A) Circuit used in G-E S21T1-B receiver, and (B) the equivalent circuit.

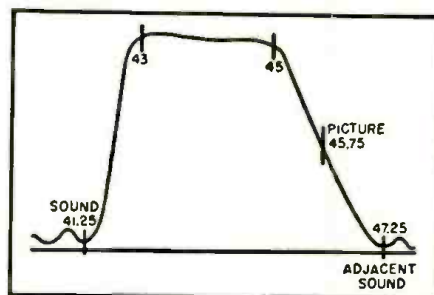
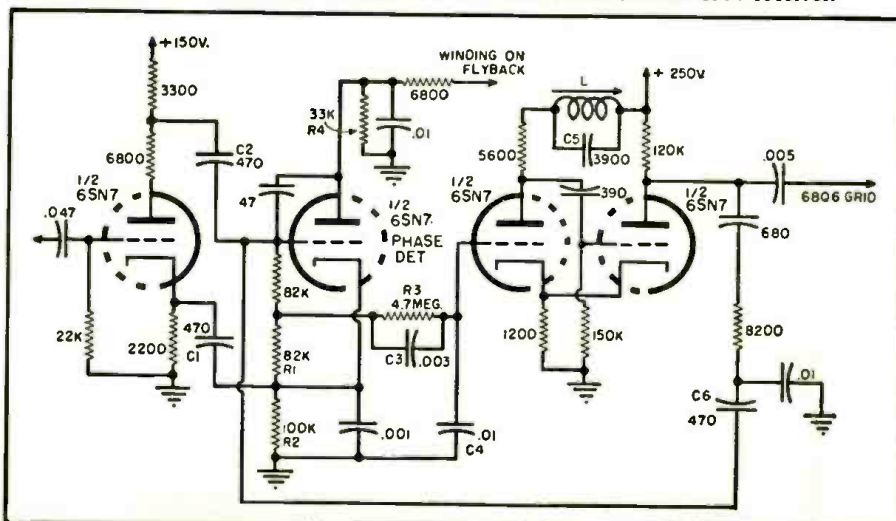

Fig. 4. Response curve with a 40 mc. i.f.

respectively. The control grid gets a low-level video signal from the second detector whose amplitude depends on the setting of a "fringe lock" potentiometer. The converter grid gets a signal of opposite phase from the plate of the first video amplifier. With only 28 volts at the plate of the 6BE6, plate saturation will take place and this provides one sort of limiting. The output of the 6BE6 is clean and constant
(Continued on page 78)

Fig. 5. The triode phase detector circuit as used in the Sentinel 454-7 receiver.



A VIBRATION-PICKUP AMPLIFIER

By LOUIS E. GARNER, JR.

Construction details on a useful gadget designed to permit the analysis of various types of mechanical vibrations.

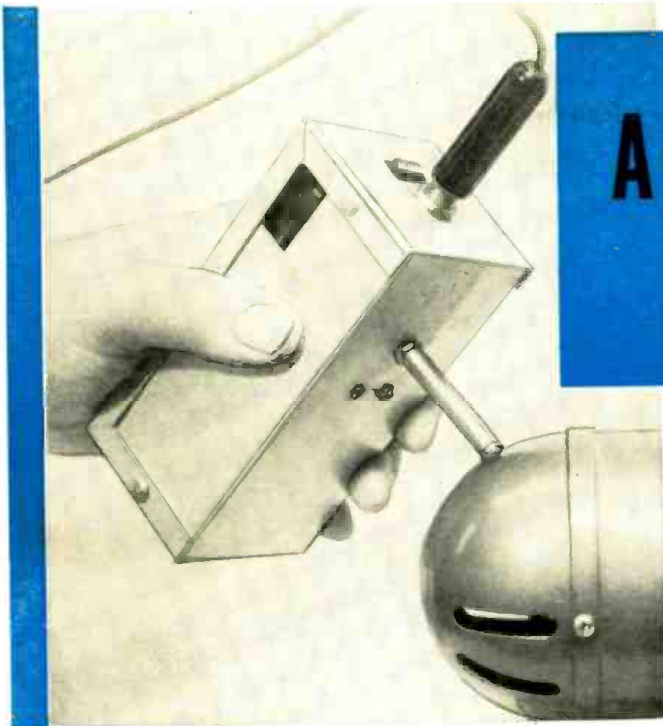

Fig. 1. Over-all view of the vibration checker in operation. It was built from hearing-aid parts.

ALTHOUGH the instrument shown in Fig. 1 is basically a general-purpose vibration pickup, it was originally built as an aid to a locksmith in opening balky safes. However, in addition to its more romantic role in opening safes, it is of value to watch repairmen, to refrigeration and washing machine mechanics, to automobile mechanics, or to almost any worker needing to listen to and identify vibrational sounds in machinery or industrial equipment.

A vibration pickup and amplifier is not a "new" instrument, for commercial models have been available on the instrument market for a number of years. Unfortunately for the average potential user, however, these instruments have been very expensive, with

the average cost running into hundreds of dollars. Such a price is not excessive when it is remembered that the commercially-available, laboratory-type instruments are designed for such purposes as accurately measuring the amplitude of vibration, frequency of vibration, and other characteristics. The instrument shown in Fig. 1, on the other hand, is designed solely to permit the user to listen to any vibrations that may be present—relying on his own experience to identify the various sounds. The instrument may be built for as little as \$30, exclusive of labor!

The "heart" of the instrument is a used hearing-aid amplifier, and the purchase of this item represents the largest single cost of all items used in the construction of the device.

Circuit Description

The schematic diagram given in Fig. 4 applies to the hearing-aid amplifier used by the author. This is from an older hearing-aid and does not supply as much gain as may be obtained from newer units. However, the results obtained were satisfactory.

In operation, the probe is held against the safe (or piece of machinery). Any vibrations present are transferred along the probe to the case of the crystal cartridge, where a relative movement is set up between

the crystal element and the case. This movement results in an a.c. signal voltage being developed which is proportional to the amplitude and frequency of vibration.

The a.c. signal developed is applied to the grid of a subminiature tetrode amplifier, V_1 , with R_1 acting as the grid resistor. An amplified signal appears across the inductive load (coil CH_1) and is coupled through condenser C_2 to volume control R_2 .

R_3 and C_1 are the screen-dropping resistor and bypass condenser, respectively, for the first amplifier stage. R_4 is a filament dropping resistor, used because the filament voltage requirement of V_1 is less than supplied by a standard penlight cell.

The signal is next applied to the grid of the power amplifier stage, V_2 , which is coupled to the earphones by means of a miniature output transformer, T_1 . C_3 is a small bypass condenser used to bypass higher frequency signals and thus to simultaneously reduce effects of harmonic distortion and to reduce any tendency towards parasitic oscillation. A conventional "losser"-type tone control is employed, consisting of C_4 and R_5 .

Power is supplied by a penlight cell "A" battery (B_1) and a hearing-aid type "B" battery (B_2). Switch S_1 is a small slide switch, but, if preferred, may be a rotary switch on either the "Volume" or "Tone" controls.

Construction Hints

Although the diagram in Fig. 4 is for a commercial hearing-aid amplifier, it may be duplicated with easily available parts, as indicated in the accompanying parts list. Tube base connections are given in the inset.

RADIO & TELEVISION NEWS

Fig. 2. (A) Cross-sectional view showing the mounting of the pickup cartridge and probe. (B) How the batteries are mounted by means of small right-angle brackets and plastic.

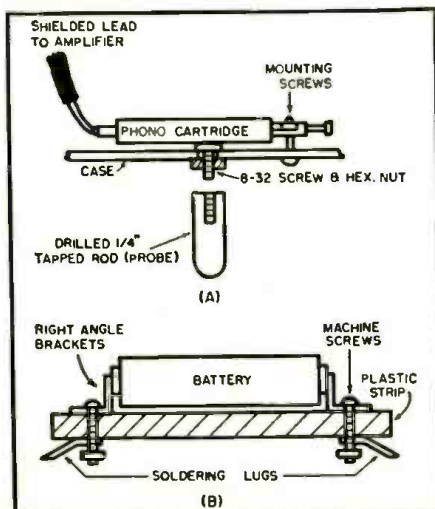

Fig. 3. Details of the probe illustrated in the photographs. See text for full details.



However, it is recommended that the builder purchase a used hearing-aid to obtain the necessary amplifier, both from the viewpoint of ease of construction and lower actual cost. Hearing-aid amplifiers in good condition can generally be purchased at from eight to fifteen dollars, less batteries, but with tubes. (It is not necessary that the circuit in Fig. 4 be duplicated.) If there is no local source of used hearing-aids, the *Centralab* Model 200 "AMPEC" printed circuit amplifier may be used instead. This small amplifier may be purchased from almost all mail-order radio supply houses.

The general interior arrangement of the amplifier, batteries, and crystal pickup cartridge is shown in Fig. 5, while a cross-sectional view showing the mounting of the pickup cartridge and probe is given in Fig. 2A. All components have been mounted in a small *Bud* "Minibox."

The length of the probe rod is not critical, but it should not be longer than 8" for maximum efficiency. The probe used in the author's model is only about 3" long. Steel or brass ($\frac{1}{4}$ or $\frac{3}{8}$ in. dia.) should be used for the rod. Do not make the probe rod of polystyrene, bakelite, or similar plastic.

To assemble the complete unit, remove the hearing-aid amplifier from its original case (where a used hearing-aid has been purchased, the original case will generally be cracked or damaged), and mount the amplifier in a standard metal utility box (steel or aluminum). Choose the smallest available box that will still provide room for easy mounting of the amplifier, batteries, crystal cartridge, and phone jack. A narrow box is preferred so that the entire unit may be easily held in one hand (Fig. 1).

The microphone used in the original hearing-aid is disconnected and removed.

Mount the crystal cartridge and probe in the box as shown in Fig. 2A, and connect a shielded lead from the cartridge to the previous microphone input connections. Almost any type of phonograph crystal cartridge may be used in this application. However, for best results, a high output cartridge should be employed. A metal-cased cartridge is much preferred over a plastic-cased cartridge. In general, the less expensive cartridges will give better results in this application.

Make sure, however, that the probe rod bears against the case of the cartridge (through the mounting screw). A binding head screw should be used to provide a large bearing area. Even then, the screwhead may be filed flat to improve contact.

If a modern hearing-aid amplifier is used, mounting clips for the required batteries will already be provided. However, if an older amplifier (or the *Centralab* "AMPEC" unit) is employed, it will be necessary for the builder to assemble his own mounting clips. This may best be done by using

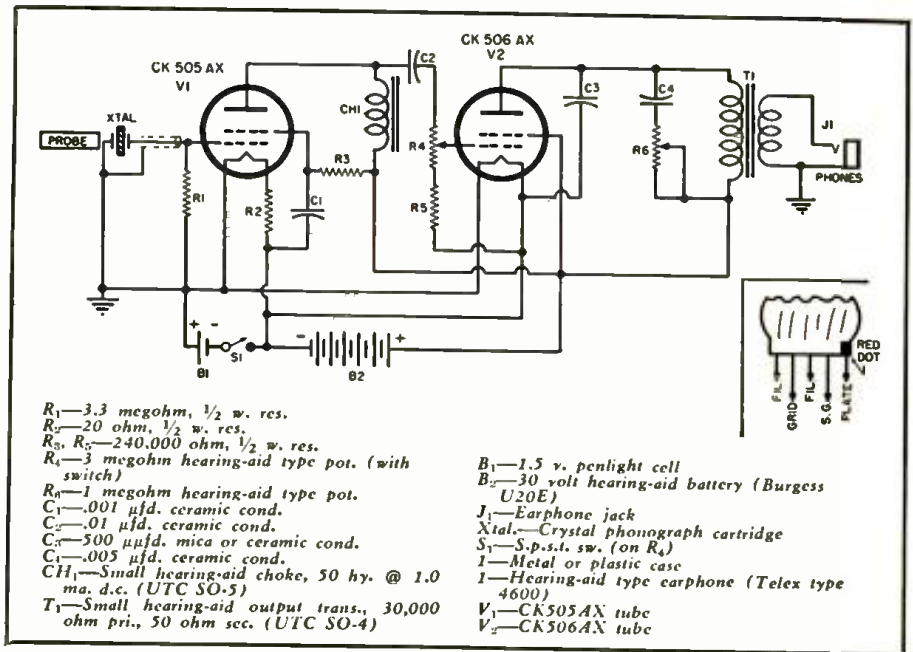

Fig. 4. Complete circuit diagram of the vibration-checker amplifier.

small right-angle brackets and a piece of bakelite or other plastic (see Fig. 2B).

Longer-life mercury cells may be substituted for the penlight "A" battery if preferred. However, the battery mounting clips will have to be designed accordingly. (Mercury "A" batteries are available in a wide variety of shapes and sizes—the *Mallory* type RM-1200 is about the same shape and size as a standard "Z" penlight cell.)

A standard phone jack is used in place of the small hearing-aid jack generally provided to permit better contact and a sturdier connection.

The output shown in Fig. 4 may not always be provided. In some cases, a choke or resistor will be used as the output load in place of transformer

T₁. Where the "AMPEC" amplifier is used, the output load is not part of the amplifier, and either a transformer, choke, or resistor may be used, at the discretion of the builder.

In general, the type of load will not appreciably affect the operation of the unit (although somewhat better low frequency response is obtained with resistive loads), but it will govern the type of earphones used. Where a transformer is used, low impedance (128 ohm or 50 ohm) earphones should be employed. Where a choke or resistor output is provided (with d.c. blocking condenser), high impedance (2000 ohm) earphones must be used, and crystal headphones are preferred.

Once the wiring and assembly have
(Continued on page 129)

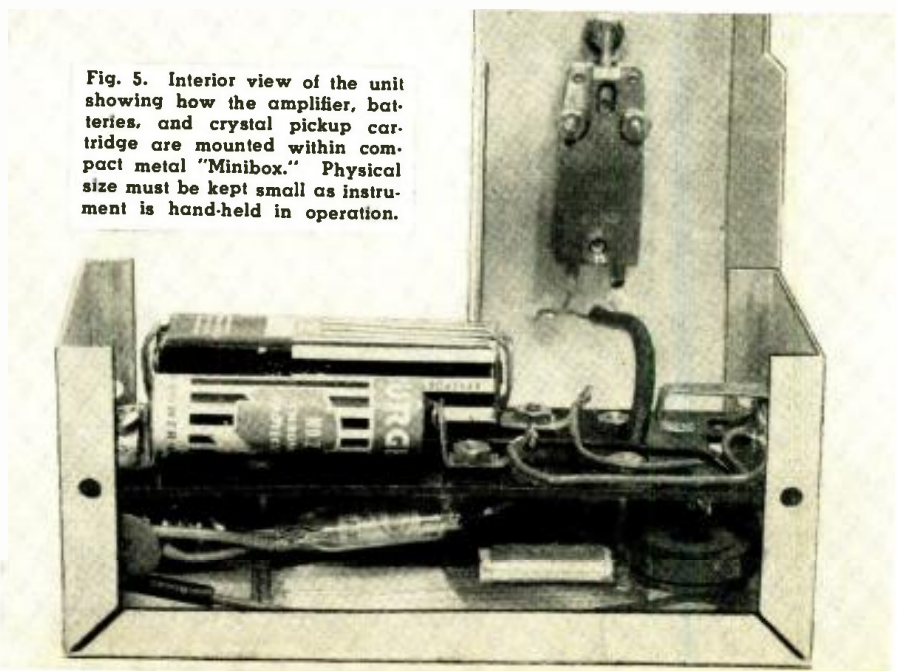
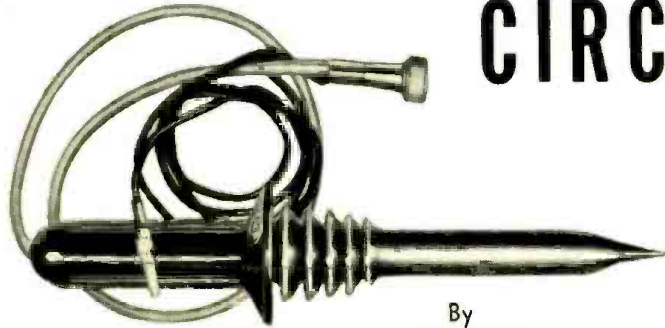

Fig. 5. Interior view of the unit showing how the amplifier, batteries, and crystal pickup cartridge are mounted within compact metal "Minibox." Physical size must be kept small as instrument is hand-held in operation.

SIGNAL TRACING IN HIGH-VOLTAGE TV CIRCUITS



The RCA WO-56A oscilloscope and the company's WG-289 high-voltage probe. This equipment was employed in making signal-tracing tests described.

By

ART LIEBSCHER

Tube Dept., Radio Corporation of America

Trace high-voltage circuit troubles rapidly and efficiently using signal-tracing techniques described in this article.

TROUBLES in high-voltage circuits, such as the horizontal-deflection-output and high-voltage stages of a television receiver, can often be located and corrected very quickly if signal-tracing techniques and a suitable oscilloscope are used. The high voltages involved, however, require that a high-voltage probe be used for personal safety and to prevent damage to the oscilloscope input circuits. A probe such as the RCA high-voltage probe WG-289 is suitable for such applications. When it is connected to the vertical amplifier d.c. input of an oscilloscope, such as the RCA WO-56A, the multiplying resistor in the probe and the internal resistance of the oscilloscope function as a voltage-dividing network. This arrangement can provide a reduction ratio on the order

of 1000 to 1, depending upon the internal resistance of the oscilloscope. A 20-kilovolt source, for example, would provide a 20-volt signal to the scope input.

Oscilloscopes having provision for a.c. input only require the addition of an external one-megohm resistance between the vertical-input connector and ground to complete the d.c. path. If this d.c. path is not provided, the full applied high-voltage can be present at the probe output and may cause breakdown of the oscilloscope input condensers or other parts rated for lower voltages.

The a.c. voltage division with this arrangement is, of course, not as accurate as d.c. voltage division because the capacitance between the probe body and ground varies with every



change in the position in which the probe is held. Because this capacitance shunts the spiral-wound probe resistance and its distributed capacitance, the divider ratio for a.c. is variable. These a.c. voltage-divider variations, due to capacitance variations, are particularly noticeable at the 15.750 cycle horizontal-deflection frequency. For high-voltage signal-tracing purposes, however, it is not necessary to measure the amplitude of a voltage waveform; usually all the indication required is the presence and shape of the a.c. voltage.

General Considerations

Before waveforms indicative of component failures in typical horizontal-deflection and high-voltage circuits are discussed, it is desirable to consider some general problems concerning high-voltage signal tracing. Experience and careful observation are, of course, two major requirements for the mastery of any troubleshooting technique.

As the probe approaches within a short distance of a high-voltage point, the same waveform that is observed when contact is made with this point is usually produced on the oscilloscope screen, although less distinctly. Sudden sharpening of the waveform at the moment of contact is more noticeable than change in amplitude. Corona or arcing prior to contact is identical to that experienced when d.c. measurements are made. The oscilloscope image obtained as the high-voltage-probe tip approaches the cap of a 1B3GT rectifier in a conventional horizontal-deflection and high-voltage circuit is shown in Fig. 1A. The apparent vertical spread of the trace is actually a multiplicity of traces produced at varying d.c. levels as the corona breaks down to form unlike but successive ionized air paths. Fig. 1B shows the waveform obtained by direct contact with the cap of the 1B3GT. The high-voltage TV horizontal pulse will fall in the center of the scope sweep trace if the sweep is timed to be the

Horizontal output and high-voltage section of the RCA 17T153 television receiver which was used in obtaining the waveform photographs shown in article.

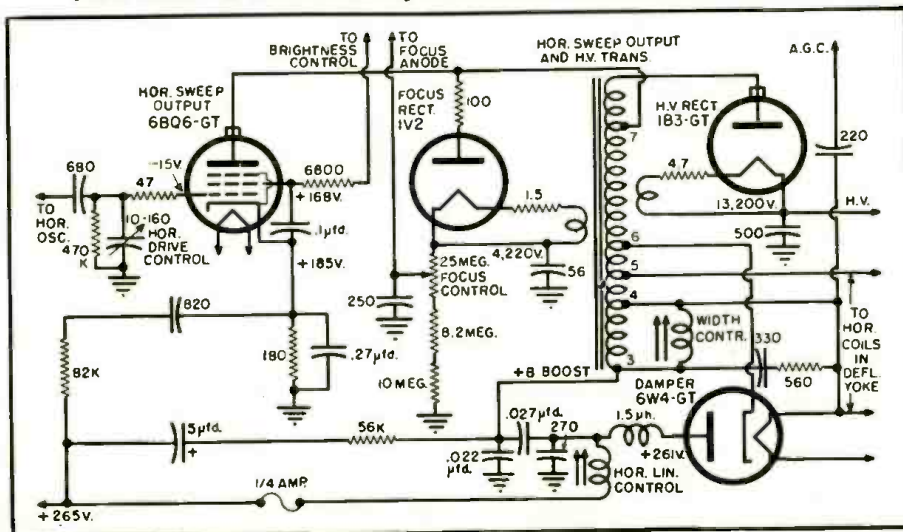

equivalent of two horizontal lines. The tapered waveform between pulses is highly damped oscillation originating with the return-trace action. The presence of a high-voltage waveform gives assurance that the 15,750 cycle pulse is reaching the rectifier tube. Failure to obtain a high-voltage d.c. output can then be attributed to a defective rectifier or other trouble in the d.c. circuit.

Although the peak voltage of the pulse applied to the rectifier should theoretically equal the d.c. level at the rectifier output, an uncompensated probe cannot be expected to measure the peak value correctly. For test purposes, therefore, it is more practical to depend on the calibrated d.c. measurement of an unloaded rectifier output as a good indication of the peak input voltage.

The photograph of the waveform at the plate connection of the horizontal-output tube, shown in Fig. 2B, looks considerably like that of the high-voltage waveform shown in Fig. 1B. There are, however, two discernible differences: In Fig. 2B, the damped wave between pulses is less pronounced, and the pulse peaks are not as pointed. It is the similarity between the two waveforms, however, that is important because the response of both waveforms to the same defects in the deflection circuit is also similar. This similarity makes it possible to observe significant changes at the output tube where the normal pulse voltage is on the order of 6 kv., rather than at the high-voltage connection where the voltage may be more than twice as high.

Crosstalk

Another factor which should be considered when a high-voltage probe is used is that crosstalk fields in and around the high-voltage section of a TV receiver enter the unshielded portion of the probe and produce undesired currents in the internal dropping resistor. These currents mix with the desired currents and distort the observed waveform.

For purposes of comparison, Fig. 2A shows a typical waveform obtained when a low-capacitance probe (WG-216B) is placed near the plate cap of the horizontal output tube. Because of the relatively low peak rating of that probe, direct contact with the plate cap was avoided. Essential duplication of the waveform in Fig. 2A is obtained by direct contact of the high-voltage probe, as shown in Fig. 2B. The effects of crosstalk can be seen by a careful comparison of Fig. 2A and Fig. 2B. In Fig. 2B a change of waveform appears in the form of a short ripple immediately following the pulse. This point of change, which does not resemble the corresponding points in Figs. 2A or 1B, can only be observed in the absence of crosstalk.

Although the crosstalk due to the higher voltage applied to the rectifier plate is present around the plate cap

(Continued on page 112)

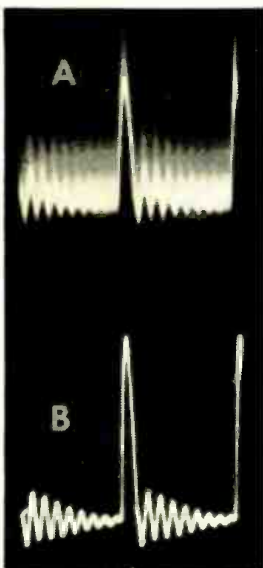

Fig. 1. (A) Waveform at top cap of HV rectifier, probe held short distance from cap. (B) Waveform at top of the HV rectifier with probe touching cap.

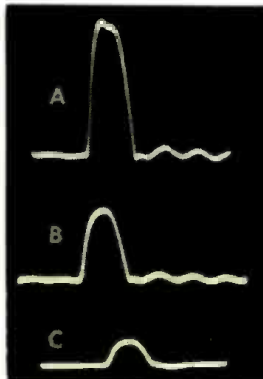

Fig. 5. Expanded waveform at plate of horizontal output tube with (A) normal 117-volt line voltage. (B) Line voltage reduced to 80 volts. (C) Line voltage reduced to 60 volts. Note reduction in pulse amplitude is coincident with leveling of the baseline.

Fig. 9. Waveform at plate of horizontal output tube. (A) One-half of horizontal deflecting yoke shorted, and (B) open-circuited horizontal deflecting yoke.

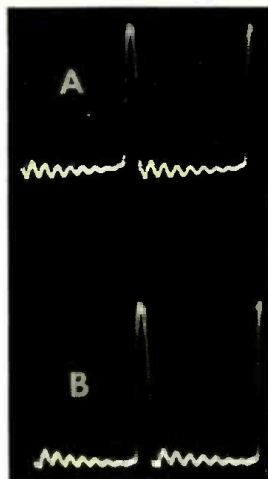
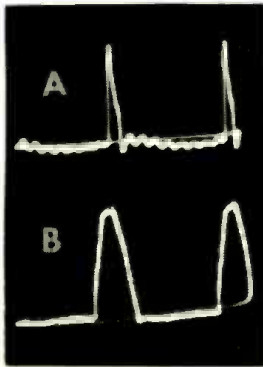

Fig. 2. (A) Waveform at the plate of horizontal output tube. Low capacitance probe held short distance from cap. (B) With high-voltage probe making a contact.

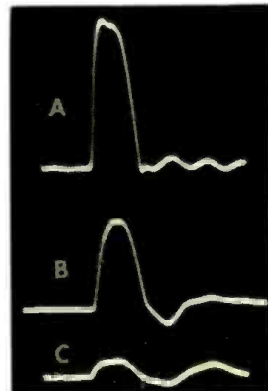

Fig. 6. Expanded waveform at plate of horizontal output tube with: (A) Normal damper tube operation. (B) Damper tube heater voltage reduced approximately 50 per-cent. (C) Damper tube heater voltage reduced approximately 70 per-cent. Note how the baseline becomes warped with a reduction in the amplitude of the pulse.

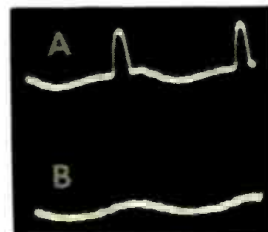

Fig. 8. Waveform at plate of horizontal output tube. (A) Damper tube heater-to-cathode leakage of 10,000 ohms. (B) Damper tube with a heater-to-cathode short.

Fig. 10. Waveform at plate of horizontal output tube. Linearity control shorted.

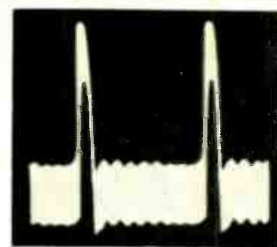

Fig. 3. Hum mixed with high-voltage waveform can be the cause of a vertically expanded trace.

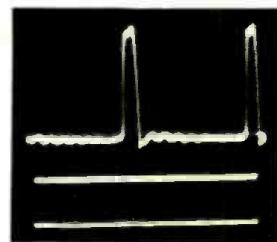

Fig. 4. The d.c. scope indication of different "B+" voltage levels. This triple exposure shows: (top) waveshape and boosted "B+" voltage level at damper cathode, (center) "B+" level, and (bottom) the zero d.c. signal level.

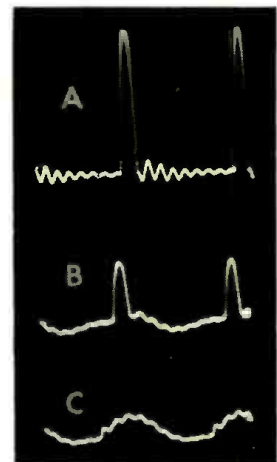
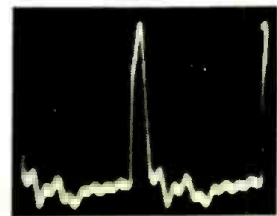

Fig. 7. Waveform at plate of horizontal output tube. (A) Normal operation. (B) Insufficient damper emission. (C) Damper emission too low for raster lighting.

Fig. 11. Waveform at plate of horizontal output tube. Open winding on portion of output transformer shunted by width control.



A BETTER ELECTRONIC KEY

By
JACK D. GALLAGHER
W5HZB

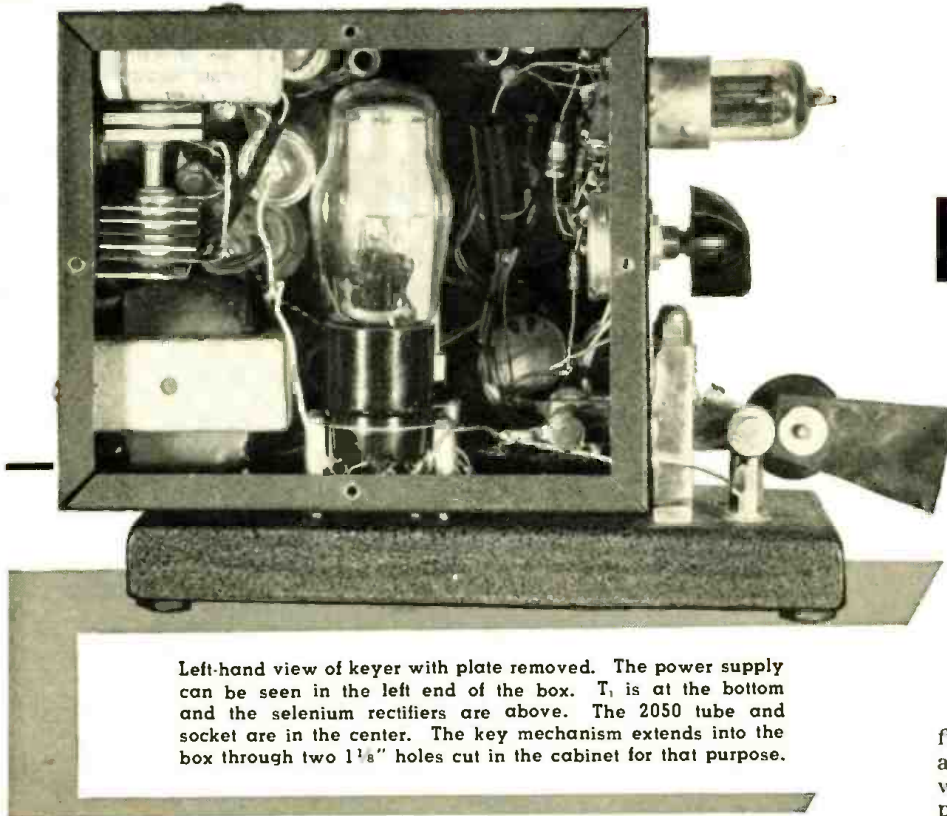

Left-hand view of keyer with plate removed. The power supply can be seen in the left end of the box. T_1 is at the bottom and the selenium rectifiers are above. The 2050 tube and socket are in the center. The key mechanism extends into the box through two 1 $\frac{1}{8}$ " holes cut in the cabinet for that purpose.

Construction details on an electronic keyer which produces self-completing dots and dashes, with or without a relay.

WITHIN the past few years numerous circuits have been developed which produce automatic dots and dashes. These keyers have been developed to the point where it is impossible for the operator to cut dashes short, or crowd dots and dashes together into an unrecognizable series of sounds. Such an arrangement, of course, permits the operator to send better and tends to develop spacing between letters or words. It is important for the potential builder to scan the available literature for an electronic key which will produce automatic self-completing dots and dashes. The keyer should be easy to construct, flexible with respect to adjustments, and stable in its operation. The use of more than one relay should not be a requirement of the circuit. A better electronic key would be one which would work with or without a relay.

The circuit diagram shown in Fig. 2 will meet all of these requirements. Extreme care has been taken by the author to provide only those elements which are absolutely required, that is: a timing circuit, a d.c. amplifier, a keyer tube or relay, a power supply, and a keying mechanism. Over a dozen different circuits were tried over a period of approximately three months before the final circuit was produced. Many types of neon lamps and VR tubes were tried in place of the 2050 thyratron without success. The 2050 tetrode was converted into a very sen-

sitive triode thyratron by connecting the screen to the cathode. Referring to the curve in Fig. 1, small changes in grid bias change the firing point of the tube. Once the tube has been fired by voltage being applied to its plate, the grid no longer controls the tube conduction. The tube will stop conducting when the plate potential has been reduced to the extinguishing point. The miniature type 2D21 thyratron will also work with minor changes in bias voltages.

The complete operation of the circuit is not complicated and can best be explained by referring to Fig. 2. The following events will take place when the key lever is pushed to the right to produce dots:

Fig. 1. Performance curve of the 2050 tube.

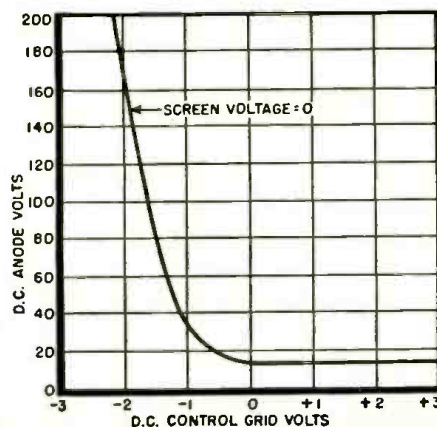

1. The ground is removed from R_5 .
2. The cathode of V_1 is grounded, firing the tube, which discharges C_1 , and makes the grid of V_{2a} negative with respect to its cathode. The lower positive voltage now present on the cathode of V_{2a} causes the grid of V_{2a} to become negative with respect to its cathode and is cut off. This change causes the plate voltage of V_{2a} to rise. This rise in voltage causes the grid of V_3 to become positive with respect to its cathode and V_3 conducts, operating the relay.

3. As soon as the plate voltage on V_1 drops to the extinguishing voltage, V_1 ceases to conduct. The grid of V_{2a} becomes zero and the timing circuit charges through V_{2a} . As the positive voltage on the cathode of V_{2a} rises, V_{2a} conducts cutting off V_3 and opening the relay.

4. When the voltage in the timing circuit has reached a point corresponding to the firing point determined by the negative voltage on the grid of V_1 , the tube will fire again, and as long as the key is held in the dot (or dash) position this operation will repeat.

In the dash position, the key retains the ground on the dot-dash ratio control, R_5 , through the normally-closed contact on the key mechanism, and at the same time grounds the cathode of V_1 causing the timing circuit to discharge. Since R_5 remains shorted when dashes are made, a greater voltage exists on C_1 and hence a longer discharge time occurs. The difference in charging voltage appearing across C_1 , due to the addition or subtraction of R_5 , causes the circuit to produce dots and dashes.

In the idle condition the cathode of V_{2a} is positive with respect to ground. The cathode of V_{2a} , the d.c. amplifier, is adjusted so that the tube conducts. The voltage drop from the plate of V_{2a} through R_{12} and R_{13} to ground causes the grid of V_3 to be slightly positive with respect to ground. R_{11}

and R_{15} are of such value as to cause the cathode of V_3 to be more positive than the grid. The difference in these voltages should be sufficient to cause whatever triode keyer tube is used to be in a non-conducting condition. Such an arrangement, of course, allows the keying relay to be disregarded entirely. For instance, if a transmitter is equipped with an oscillator whose plate current is on the order of 10 ma. or less, the plate of V_3 may be connected directly to the cathode of the oscillator as in cathode keying. Adjustments of the bias voltages in the keyed stage and in the keyer tube will have to be made. If a larger current carrying capacity is required in the keyer tube, the elements of the 12AU7 may be paralleled, or another tube may be substituted with appropriate changes in bias voltages.

If 6SN7's are to be used in place of the 12AU7's, it is necessary to make the following changes: Remove the 22,000 ohm resistor in series with the plate of V_{2a} . Remove R_8 and replace with a 1.5 megohm, 1/2 watt resistor. Replace R_9 with a 1/2 megohm, 1/2 watt resistor. Replace R_{12} with a 1 megohm, 1/2 watt resistor. Replace R_{11} with a 2200 ohm, 1 watt resistor. For preliminary adjustments R_{11} should be variable until the best operating point is obtained. Other than changing pin numbers, the changes mentioned are the only ones necessary when using the 6SN7 type tube. Other combinations of resistances will also allow the circuit to perform as it should, but trial and error substitution can be a tedious and time consuming operation.

Like most hams, the author continued to experiment with the circuit of this key and found that the circuit performed just as well by removing R_8 , R_{11} , and C_5 . The junction of R_{10} and the secondary of the transformer T_1 should be grounded, of course. This leaves the grid (pin 5) of the 2050 open, which is of no consequence. Some of the steady-state voltages of Fig. 2 will change slightly, but adjustments of R_8 and R_{10} , as described later in the article, will have to be made. If the foregoing changes are made, changing the value of R_8 from 1 megohm to 1.5 megohms will reduce the speed if desired. No other changes are necessary.

The adjustment of the key can be carried out with ease if the values shown in the circuit of Fig. 2 have been followed. If the line voltage is lower than 117 volts, all of the voltages will be proportionally lower and small changes in R_8 and R_{10} will have to be made. A single selenium rectifier power supply is not recommended, since the adjustments become critical at this voltage and further changes in the line voltage will cause noticeable changes in the timing circuit. However, there has been no cause to regulate the supply to this keyer since small changes in line voltage do not materially affect the operation.

The relay in the plate of V_3 can be any type having "on-off" contacts, adjustable or non-adjustable. The d.c.

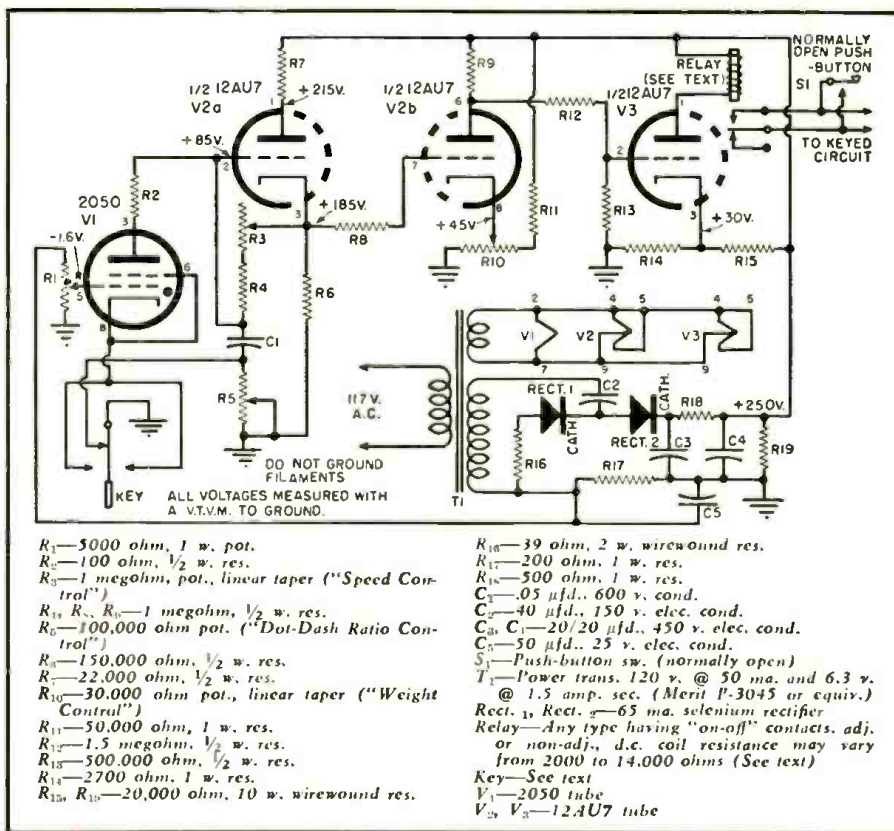
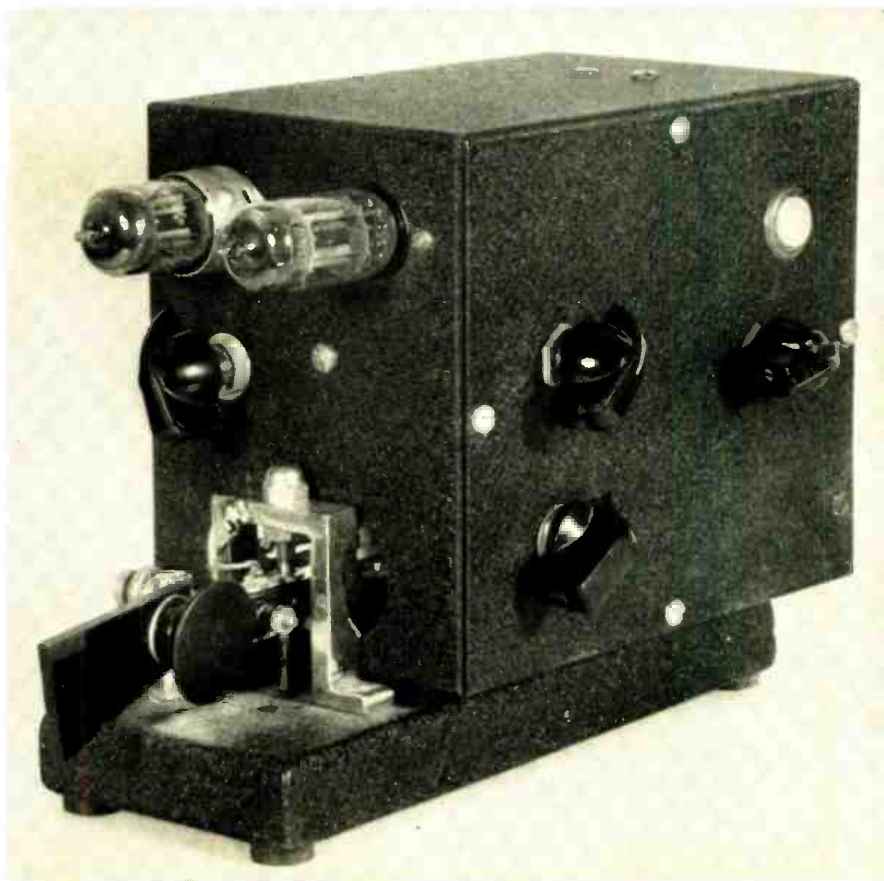

Fig. 2. Complete circuit diagram and parts list covering the electronic key.

Right-front view of keyer showing placement of various controls. On the front, at the top left-hand corner of the 4" x 5" x 6" metal box, V_3 is mounted directly above the speed control. V_2 is to the right. On the right side of keyer and on the left end of the removable side plate, the weight control, R_{10} , is mounted directly above the "dot-dash ratio control," R_8 . The grid bias adjustment on the 2050 is mounted below the normally-open push-button switch at rear.



coil resistance may vary from 2000 ohms to 14,000 ohms. V_3 will still key the relay, but it must be remembered, of course, that the relay should operate at the current for which it was designed. For instance, one type of relay having a coil resistance of 2500 ohms and designed for low current operation worked quite well at all speeds. Another type of relay whose coil resistance was 2000 ohms, but which was not designed for keying purposes also worked quite well at slow speeds, and with adjustments

worked at all speeds. The relays found in surplus Beacon receivers marked "BK-35", having a coil resistance of about 14,000 ohms, worked very well in the circuit when a resistance was placed in series with its winding to limit the current to 2 ma. A relay whose coil resistance was 4000 ohms and was sealed against manual adjustment also worked very satisfactorily.

Before any adjustments are made, short the leads of an ohmmeter and adjust for full-scale reading. Connect these leads to the open contacts on

the relay. Set the "dot-dash ratio control," R_5 , for maximum resistance. Set the speed control, R_6 , to about three-fourths of the highest speed and push the lever to the left to produce dashes. As the relay opens and closes, adjust the weight control, R_{10} , so that three-fourths of full-scale deflection is obtained on the ohmmeter. Then move the key lever to the right and adjust the "dot-dash ratio control," R_5 , until half-scale deflection is obtained on the ohmmeter. When the speed control, R_6 , is advanced or decreased, the readings obtained on the ohmmeter should not vary greatly from those obtained by previous adjustments of R_{10} and R_5 . Over the entire speed range no pronounced variation will be apparent, except at very slow speeds where the swing of the ohmmeter will become difficult to determine.

In order to check the accuracy of the "dot-dash ratio control," an electric counter was connected to the open contacts on the relay after these adjustments were completed. Dashes and dots were counted over a 10 second interval from slowest to fastest speeds with only a slight variation in dot-to-dash ratio. After a few minutes of practice, the "dot-dash" ratio can be set remarkably close simply by listening to the relay or the transmitted signal in the receiver. This control should not have to be re-adjusted once it has been set correctly.

The key mechanism was made from a standard "bug" by removing everything on the base back to the forward arm as shown in Fig. 3. Since not all keys of this type are standardized as to method of construction, Fig. 3 shows a method of utilizing the main support and key lever, or arm, without constructing a special one for use with this type of keyer. The one shown in the photographs was purchased in kit form from the *Electric Specialty Mfg. Co.*, Cedar Rapids, Iowa a few years ago for less than \$4.00. The additional contacts were taken from surplus relays and mounted as indicated. Two of the contacts may be salvaged from the part of the key that has been removed. The problem of making the key mechanism isn't as difficult as might be expected, and the method of mounting the contacts on the forward arm is left to the ingenuity of the individual. On this particular key, the forward arm is of brass and the contacts and brass mounting strips were simply soldered to the arm. Different makes of "bugs" present different problems, of course, but utilization of the existing construction greatly reduces the amount of work involved.

In closing, the writer wishes to thank W5FRE for his valuable suggestions on the development of certain portions of the circuit.

REFERENCES

1. Bartlett, F. A.: "Compact Automatic Key Design," *QST*, December, 1951.
2. Brann, Roy: "In Search for the Ideal Electronic Key," *QST*, February, 1951.

Fig. 3. Details for constructing the "bug" to be used with electronic keying unit.

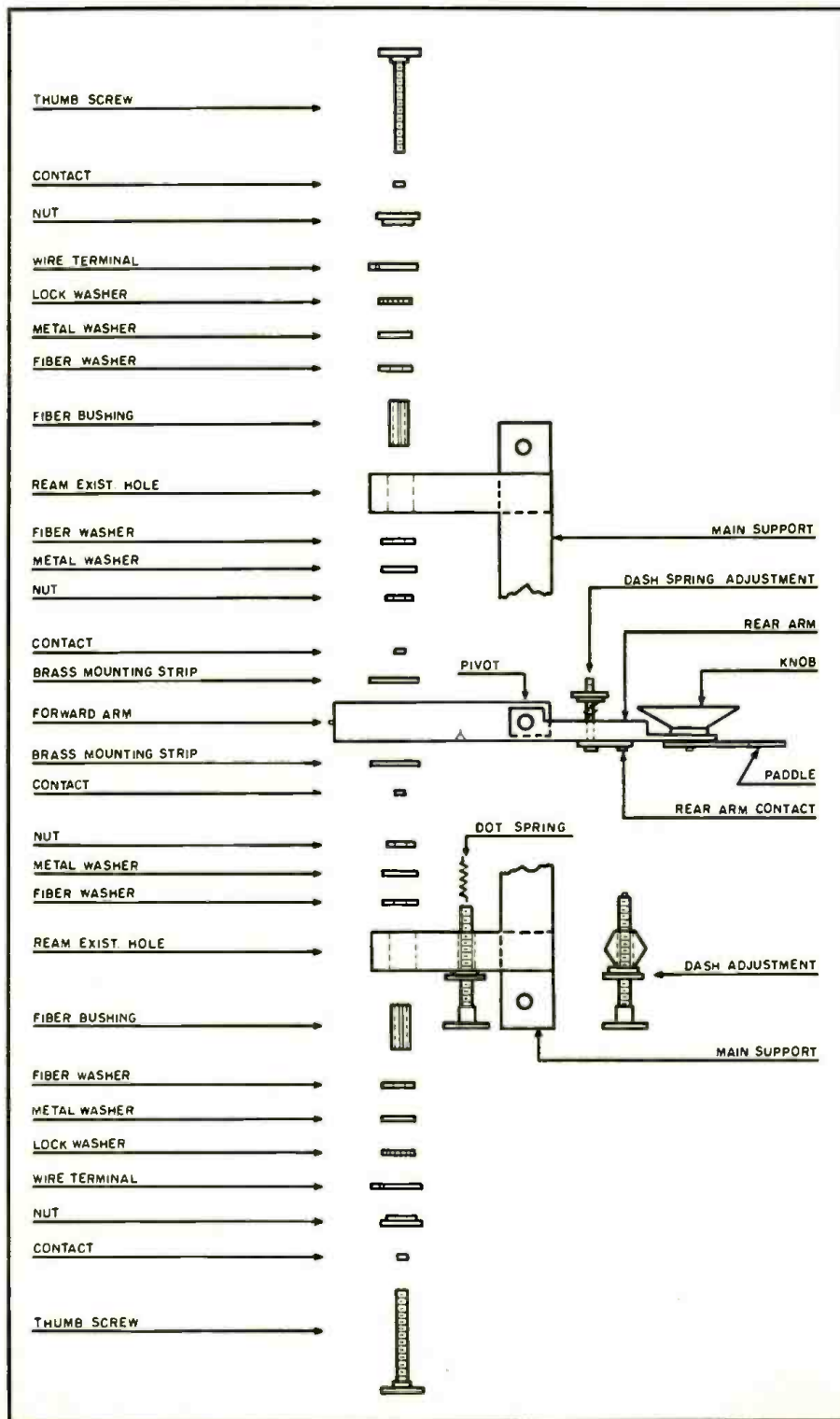

TELEVISION TODAY'S NEWS

By **RALPH HOWARD PETERSON**
Director, "Camel News Caravan"

A 15 minute newscast on your screen represents hours of preparation and the services of a highly-trained staff.



John Cameron Swayze before the cameras for the "Camel News Caravan."

PUTTING together the "Camel News Caravan" every day for the television network of the *National Broadcasting Company* might be compared to running a push-button desk for myriad magic carpets and genii all over the world. Because that is what we do through the magic carpets of modern communications and transportation, through the coordinated efforts of a highly skilled staff as we bring actual events from all over the world to the television screen each day.

Only, it is not that simple, nor that easy.

To carry viewers from Seoul to Budapest, from baseball field to the White House, to picture "Today's News Today," calls for a fabulous organization, a highly complicated operation and great expense. We must be ready with manpower and equipment to cover anything that happens in any accessible point on the globe.

This series was started in February 1948 as a straight newsreel program. Newsreel film was edited and put on the network with suitable commentary background. However, television outgrew this form of news coverage very quickly, so the program was turned over to the NBC-TV News Division which developed the technique of mixing live action pickup with film.

Often the program involves at least a dozen switches from New York headquarters to other cities and back again.

Film is being rushed in constantly from more than 100 cameramen stationed strategically around the world.

Producing television's most popular network news show is a 24-hour-a-day job. But take the typical day at the NBC-TV Uptown Studios in the Pathe Building at 106th Street, Manhattan, our headquarters.

Editor John Lynch checks over the incoming news, then he confers with our staff, including Chief Writer Reuven Frank and myself. We decide what is the day's big news and how we can cover it. We check over reports from correspondents and representatives all over the world. Telegrams, cables, radiograms, and trans-oceanic phone calls carry the assignments and instructions.

We spend the day rushing back and forth between our offices with its news teletypes and the movie projection room where we review film as it arrives.

In the last year, "Camel News Caravan" ordered 250

miles of 16 mm. and 35 mm. film shot. Thirty-five miles of film were shown on the program.

This film may be brought by the cameraman himself from a local fire or a local political event around the corner, or rushed by special courier, jet plane, trans-ocean air liner, and motorcycle from some remote corner of the globe. Most of it arrives undeveloped and is prepared for viewing by a laboratory staff here. For this reason, many of our cameramen never see the film they shoot and send in film that millions of viewers see as a routine part of their evenings at home.

One-third of all films included on the Caravan arrive too late to be developed and printed by air time. To make the evening deadline with them, we project the negatives by a special apparatus with reversed polarity. This gives a normal picture to show last-minute news.

To the 16 mm. and 35 mm. sound and silent films from all over, we add the on-camera commentary by John Cameron Swayze in New York, by Bill Henry and David Brinkley in Washington, by Edward Wallace in Cleveland, by Clifton Utley, Jim Hurlbut, and Clint Youle in Chicago, by others in Boston, Los Angeles, and San Francisco.

Also in the New York studio, we carry the film story with off-camera voices of newscasters like Kenneth Banghart, Radcliffe Hall, Don Goddard, and Bob Wilson. Connie Lempke is the off-camera voice of fashion.

We go through the motions of a rehearsal about 7:15 o'clock to make up our show. This is essential in blending as many as fifteen different segments into the smooth-flowing news program that appears on the coast-to-coast hookup at 7:45 p.m., New York Time. But, at rehearsal, probably half of the segments are not shown. These are picked up from other cities during the actual show, or received at our studios between the rehearsal and the telecast.

Our technique has been improving steadily through the years; our world covering staff grows in size and skill. NBC Vice-President William F. Brooks has described the Caravan as "a major step in adapting the tools of a new medium, television, to the age-old job of reporting news." Also, he might add, it is adapting the great developments of a scientific age to the art of news reporting.

PHASE-SHIFT TONE CONTROLS

By
GLEN SOUTHWORTH

An interesting and thought-provoking article on a novel method of achieving tone control with simple RC circuits.

UP TO the present time interest in the effects of phase shift on audio reproduction has largely been confined to the designers of wide-band amplifiers employing large amounts of inverse feedback. In other elements of the reproducing chain, such as loudspeakers, pickups, and other devices, relatively large phase shifts may occur. Previously, phase distortion has been held to be of little importance in monaural reproduction due to the fact that much larger phase shifts may occur due to acoustics and similarly some listening tests involving controllable phase shifts in the audio circuits appeared to indicate that the average listener was very tolerant of this form of distortion.

In considering the possible effects of phase it should be noted that a special case with important characteristics results when two signals of varying phase are mixed. A situation of this nature can arise at several points in the reproducing setup: at the microphone, in equalization circuits, in feedback circuits containing reactive elements, in electro-mechanical devices, and in the acoustic environment of the listener. Some of the possible effects are shown in the accompanying illustrations. If one wave train is delayed for one-half cycle, or 180 degrees, and mixed with another wave train of equal amplitude, the cancellation of all but the first and last half cycles will result. If an audio system were constructed with this form of characteristic over a wide frequency range, the resultant reproduction would greatly discriminate against sine-wave trains and would pass nothing but transients and the products of rapidly damped or modulated wave trains. A condition of this kind can sometimes exist in phonograph equipment and leads to an apparently excessive ratio of needle scratch to high frequencies.

If an asymmetric transient is applied to a system in which phase shift occurs and the resultant signal is mixed with the original, an actual lowering of pitch may result. The same characteristic may hold true for continuous wave trains of a lopsided

nature, such as might be caused by second harmonic distortion in an amplifier stage. The reverse of this proposition may occur if phase inversion, such as produced by an amplifier stage, is produced before the mixing occurs. In this case, the pulse now becomes symmetrical and the duration of each half cycle is shortened. Both of these effects can occur acoustically and may be the cause of a certain indistinctness of tone of some instruments when heard from a distance.

The primary effect of phase-shift mixing appears to be to change the relationships between sine waves and transients in sound reproduction and the author's experience strongly indicates that this may be one of the

Various relationships which may occur due to phase-shift mixing. (A) Pattern of continuous wave train. (B) Pattern resulting when one continuous wave train is mixed with another with less than 180 degrees of phase delay. (C) Pattern produced by two wave trains of equal amplitude but 180 degrees out-of-phase. (D) Pattern of linearly damped wave train. (E) Resultant pattern of mixing two damped wave trains 180 degrees out-of-phase. (F) Semi-logarithmically decaying wave train. (G) Pattern of result of 180 degree mixing. (H) Asymmetrical pulse. (I) Pulse delayed for less than 180 degrees and mixed with original pulse, showing increase in duration of resultant signal. (J) Pulse both delayed and inverted then mixed with original signal. (K) Resultant symmetrical signal produced, with each element having a shorter duration than original signal.

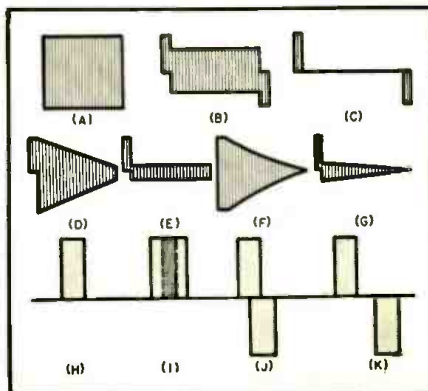

important differences between monaural and binaural hearing. The effects that can be obtained by appropriate phase delay and subsequent mixing appear to closely approximate the advantages that are claimed for binaural hearing, e. g., reduction in apparent reverberation time of room acoustics, reduced audibility of background noise, and greater clarity with less apparent distortion. The first of these characteristics may be attributed to the fact that phase mixing would tend to emphasize transients and rapidly damped wave trains while discriminating against fairly continuous sounds like hum or symmetrical noise, and tending to lower the pitch of unsymmetrical noise to a less audible region. In lowering the apparent distortion of the signal it should be noted that the recognition of distortion is to some degree a function of the duration of the distorted tone. For example, in the case of a cymbal clash, frequencies of 10,000 and 10,020 cps might be present which, if passed through a nonlinear element, would presumably give rise to a twenty-cycle beat note. If, however, the two high frequency components maintain a fixed relationship for only a few milliseconds then no effective twenty-cycle note will be generated. A similar phenomenon may be noted in sweep-frequency audio oscillators in which the low-frequency response is limited by the duration of the sweep. In general, it seems reasonable to assume that intermodulation distortion products will be most objectionable in situations where two or more frequencies bearing a constant relationship to each other are produced for an appreciable length of time. Inasmuch as a phase mixing system would tend to reproduce such sounds at a level considerably lower than otherwise, this would give the effect of lower apparent distortion in the reproduction.

Phase-shift mixing can be produced in several ways. One of the most interesting methods is acoustic mixing which may be done either by utilizing wall reflections, multiple speaker arrangements, or special baffles. In the case of wall reflections it usually seems desirable to have the speaker located out in the room with all or part of the radiation directed toward a nearby wall or corner. Variations in tonal quality may be secured by varying both the angle and the distance of the speaker from the reflecting surface and proper positioning is sometimes necessary to avoid a "hollow" effect. In addition to the phase-mixing effect an additional advantage may be obtained due to the fact that the wall reflection represents a virtual source of sound which, in combination with the direct radiation from the speaker, may be interpreted by the ears in its binaural equivalent. Similarly, the virtual sound source may cover an appreciable area of wall space and give a pleasing effect of diffusion.

In the event that it is considered

Imprecise to place the speaker and housing out on the floor, an alternative method is to use two or more separate speaker assemblies physically displaced from each other. This displacement may be either in a line away from the listener or horizontally. A large number of possible combinations may be obtained with a setup of this kind and it is desirable to provide for adjusting the relative levels of the different speakers as well as varying location and sound directivity. Under some circumstances an arrangement of this kind can be used as a form of attenuator to reduce spurious or unwanted sounds. For example, one half wavelength at 50 cycles will be approximately ten feet and in some cases the cancellation effect can be used to reduce low-frequency hum or loudspeaker hangover. In the high frequency region a similar technique could be used to reduce or eliminate a single unwanted frequency by the staggering of two closely-spaced tweeters, one slightly behind the other. Similarly, in the high-frequency region it would be practical to design special baffles with reflecting surfaces in order to achieve phase-shift effects. Such an arrangement is usually impractical at low frequencies, however, due to the large physical dimensions required.

Electronic phase-shift mixing may be achieved by means of a variety of circuits and has the advantages of convenience and compactness over the acoustic methods previously described. At low frequencies the electronic phase-shift methods are generally somewhat more effective than acoustic techniques when used in a room of limited dimensions. Electrically, a phase shift of 180 degrees is relatively easy to produce at twenty cycles, while acoustically such a phase delay would require a path length of about twenty-five feet. At high frequencies very large phase rotations may be produced acoustically as compared to those available with conventional electronic circuits.

One of the most interesting applications to which electronic phase-shift mixing may be put is in the improvement of signal-to-noise ratios in program material such as phonograph recordings. In conventional 78 rpm shellac recordings it is usually assumed that surface noise begins to be noticeable from about 3000 cps upward. This noise is largely due to small irregularities in the groove, such as caused by dirt or abrasive in the record material. These irregularities tend to cause the production of an asymmetrical transient when struck by the pickup needle. As noted earlier, when the phase of an asymmetrical waveform is shifted and inverted and then mixed with the original signal the apparent frequency of the waveform will increase. If a 90 degree phase shift is used prior to inversion and mixing, this will cause the asymmetric components of needle scratch to be doubled in frequency, thus permitting the

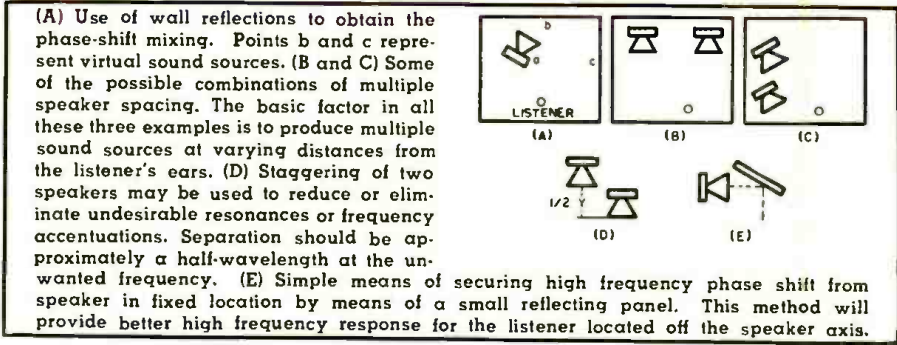

reproduction of sine waves on the recording up to approximately 6000 cycles before noise interference begins to occur. If a 45 degree phase shift is used this will presumably extend the noise region to 12,000 cps and above, although in both cases it should be noted that the peak amplitude of the transient impulses will be considerably greater in relation to the musical sine wave components. This is offset by the fact that the noise now occurs in a less audible region and may be easily attenuated by a filter network.

Several factors should be noted about a noise-reducing system of this kind. Due to the fact that it alters the frequency characteristics of transients or asymmetric waveforms only, it is not effective in reducing noise such as may be produced by a pickup with a severe ringing needle resonance. Similarly it may alter the tonal characteristics of certain sounds in the high frequency region, i.e., raising the apparent pitch of instruments such as cymbals, a not undesirable effect in recordings with a restricted frequency range. Assuming that a good pickup is used, the author's experience is that reproduction from conventional shellac recordings approaches that of vinylite or shellac with very little abrasive content. Occasional ticks or pops may be noted but the average background noise tends to become a continuous, unobtrusive, low level sound. As a matter of interest it might be noted that some pickup equalization circuits appear to be similar in operation to the phase mixing arrangement. In these circuits inverse feedback is usually applied either to the pickup itself or through some phase-shifting element thus pro-

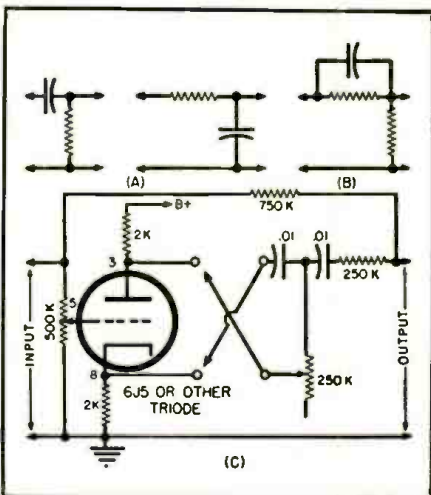

(A) Simple phase-shifting circuit. The phase-shift will equal 45 degrees when reactance of the condenser is equal to that of the resistive element. Sections may be used in series for larger phase shifts. (B) Type of high frequency equalizer that is not recommended by author because it lowers the pitch of transients such as needle scratch. (C) Phase shifting and mixing system which may be used to provide variable high or low frequency cut-off.

viding the previously specified condition of phase shift, inversion, and mixing.

Some of the circuits that can be used for phase-shift mixing are shown in the accompanying diagrams and may be used in many different combinations. Similarly it should be realized that many conventional tone controls or equalizer circuits introduce some phase shift mixing with results which may be considered desirable or not, depending upon the associated

(Continued on page 152)

(A) Generalized circuit for obtaining phase mixing. The pot. is used to obtain amplitude balance between the out-of-phase components. (B) Circuit for obtaining phase mixing and inversion. An audio transformer with the center tap grounded may be used in place of the triode, if desired. (C) Circuit for obtaining phase shift without amplitude variation. (D) Variation of wide-band phase shifting audio circuit.

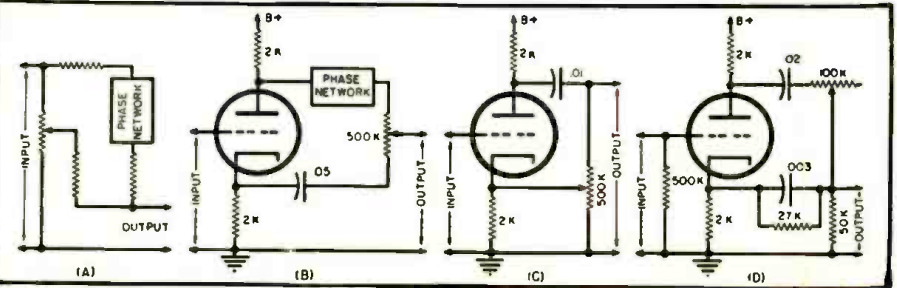

MODERNIZING THE SCR-274/N TRANSMITTER

Step-by-step data on converting a popular surplus unit to operate c.w. on 40 m. at 40 watts output.

By
CARL V. HAYS, W6RTP

SINCE the release of the surplus stock of the well-known SCR-274/N series of transmitters to the amateur buyer, several articles have appeared on adapting the rig to typical amateur uses. While excellent in themselves, most of the information left much to be desired, from our point of view.

From working with the little transmitters during most of the war years, we had naturally given some thought to how easily they could be converted to a complete c.w. rig, with a minimum of work and cost. Featuring a simple, stable v.f.o., parallel beam-power output tubes (the equivalent of 807's), with neatness and compactness, they were a natural.

The BC-459A, with coverage from 7 mc. to 9.1 mc., was our choice, since the 40 meter band is our primary c.w. favorite. Other than for the difference in frequency involved, the BC-696A (3 mc. to 4 mc.) is also an ideal ham rig, and either will respond to similar

treatment, giving either full 80-meter or 40-meter coverage, as may be desired.

Setting our shiny, brand-new BC-459A on the bench, we lit a pipe, and started looking and thinking. The photos will give a quick, clear picture of the final result envisioned, and it was surprising how little time and effort were required to achieve the desired results. A meter, a dial, a phone jack, an r.f. choke, and a condenser were all the new parts required to give a neat-looking, smooth working 40-meter rig, for a ridiculously small investment.

Removal of the top and bottom covers is the first order of the day. With the innards exposed, we removed all tubes (for safety's sake) and then carefully removed all three tuning and padding condensers below the chassis, including the dial assembly. A small *Bristo* wrench makes this a

quick and easy operation, since the gears are secured to the shafts by this type of screw. From the top of the chassis we removed the final tank coil, the antenna loading coil, and the associated hardware.

Next step is the removal of the antenna relay (immediately above the antenna loading coil) and the power relay (located below the chassis). The antenna feedthrough insulator also comes out, as well as the removable calibrated window on the panel.

The next step involved paralleling the filaments, since these rigs originally operated from a 28 volt source. Inspection of the wiring diagram will show how easily this can be done, involving only two actual wiring changes. Removal of the relay wiring facilitates this step.

Since the crystal furnished with the unit in question is an 8000 kc. one, we had no further use for the tuning eye stage (1629), so no effort was made to utilize it. Removal of its plate dropping resistor was a simple means of eliminating this stage. Reference to the diagram will show all wiring changes, as well as the pin numbers in use in the modified version.

With the wiring changes out of the way, the next step was mounting the oscillator tuning condenser C_2 , a 70 μfd . dual-bearing job (*Johnson*). This particular condenser is almost ideal for the critical job, and is recommended highly. Not only is it a ruggedly built and smooth operating thing, it just so happens that its mounting feet and its shaft-center-to-chassis measurements make an easy job out of adding it to the circuit.

Since its mounting involves going

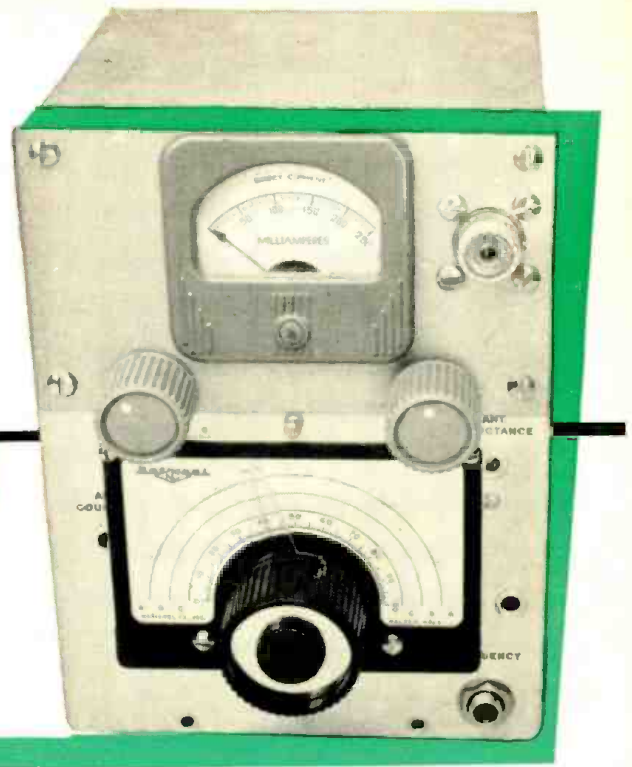

Front panel view of the converted SCR-274/N transmitter. Read instructions carefully before starting disassembly.

Underchassis view. A neat job will result if author's instructions are followed.

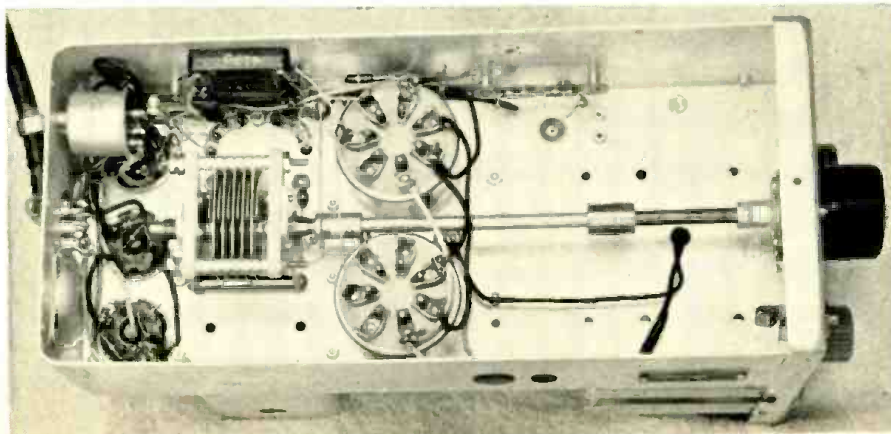

into the oscillator shield can area (to get the holes drilled for the feet) you will find it will fit with a minimum of headache. While the oscillator shield is off, the following steps are *carefully* done to the stage itself: extend the grid-leak condenser lead, taken from the original oscillator tuning condenser in the shielded area). This is necessary, since we are going to tap the new oscillator tuning condenser across part of the coil only, for bandspread purposes.

Next step is the soldering, with short rigid leads, of an auxiliary 50 μfd . silver mica or ceramic condenser C_1 across the bandset condenser. This is not an absolute necessity, but better bandspread is obtained with its addition. Its use is optional, but recommended. Now is a good time to loosen the *Bristo* screws holding the arm of the rotor clamp on the bandset condenser, and turn it full in, re-locking securely.

Final step in re-working the oscillator is the soldering of a rigid length of bare hook-up wire from the stator of the 70 μfd . tuning condenser C_2 , to the fifth turn from the top of the oscillator coil. This spreads 40 meters over about 80% of the *National* MCN dial, and gives plenty of bandspread for spotting frequency.

The indispensable grid-dipper is a handy thing to have about this time, but calibration can wait, if necessary, until power is applied, checking against the station receiver.

Comes now the final amplifier work, and here unfortunately a bit of hack-sawing is a must, in order to utilize the former final amplifier ganged tuning condenser for our purpose. Carefully saw around the frame of this condenser just below the gear drive support arms that hold the worm gear. It is a nuisance, but look at the dough you save, and the pyrex-ball insulated condensers of the SCR-274 are worth the effort alone, besides the monetary saving accomplished.

With this done, it will be found that this condenser will fit nicely to the left of the chassis, topside, immediately behind the panel. In its duplicate position on the right will also fit the former final amplifier padding condenser. An extension for its shaft will be found necessary, in order to fit it with a knob. Spot and drill holes in the panel to clear the two shafts (the panel referred to is the scrap piece of aluminum shown in the panel photo which is bolted to the front of the rig, flush with top and both sides). The two condensers are mounted to the side lips of the front panel by means of $\frac{9}{32}$ screws, tapping into the already existent holes in the condenser frames. Be sure and allow for the $\frac{2}{4}$ in. meter mounting hole during this process, since there is just enough room for all of them to fit.

Using the former clearance hole for the previous dial as a marker point,

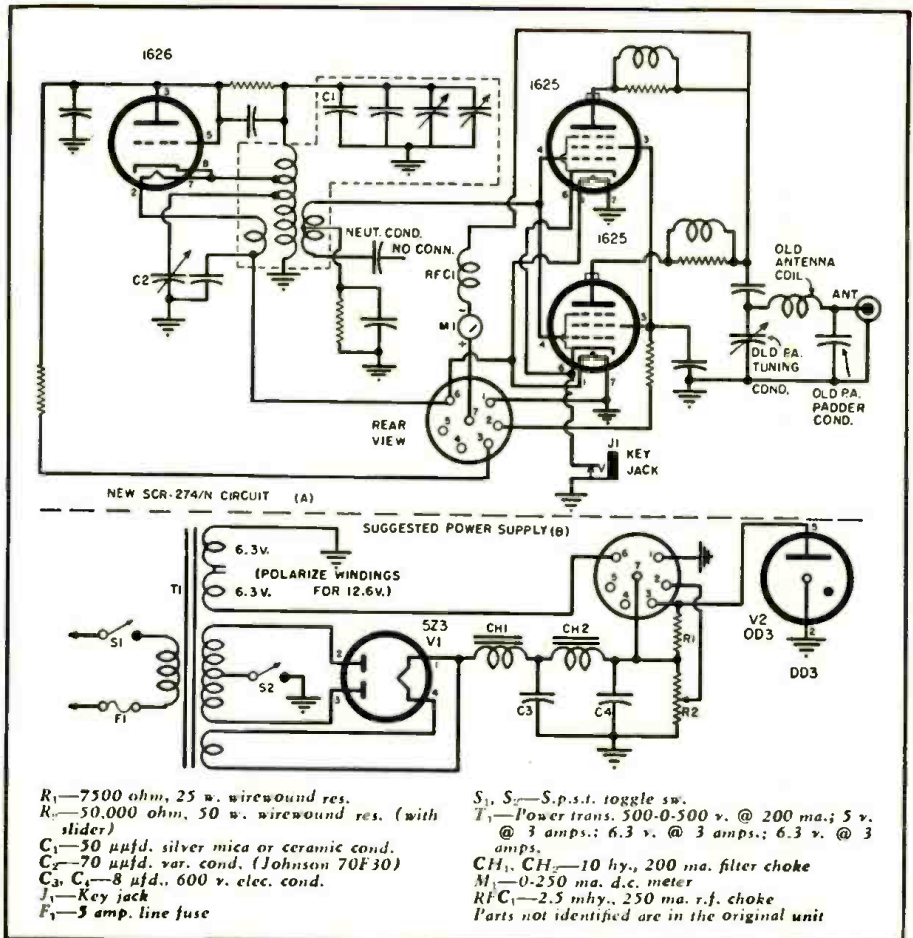

(A) Diagram of SCR-274/N showing required changes. (B) Suitable power supply for unit.

lay out your oscillator tuning condenser shaft center-point, and file or punch the panel to accept the MCN dial assembly drive unit. Some additional chopping of this unit opposite the factory cutting will allow it to fit nicely under the chassis. Ten minutes' work will do the trick, and the resulting operation will justify it.

Retrieve the mounting lugs from the former final amplifier tank coil assembly, the 1625 plate clips with the parasitic suppressors attached, and using the lugs, mount the former an-

tenna loading coil (minus, of course, its slider assembly) in the spot formerly occupied by the old tank coil. Careful use of short bits of the old tank coil wire, soldered to the lugs, and inserted in the convenient holes found in the ceramic form ends, will secure it rigidly and quickly to the chassis.

Make up, from the former mica 1625 plate bypass condenser and the two plate clips, and a 2.5 mhy. r.f. choke RFC_1 , the parallel feed system shown (Continued on page 125)

Top chassis view of converted unit. A compact, stable unit for c.w. is the result.

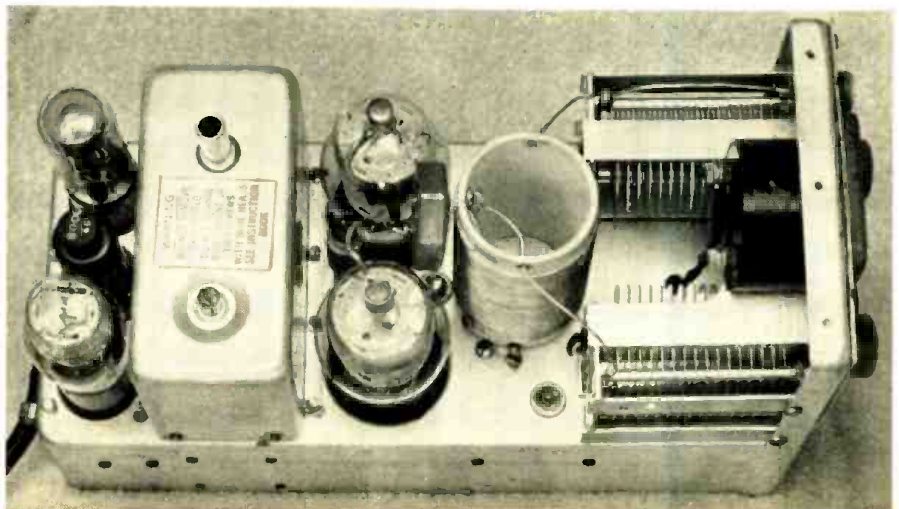

MAC'S RADIO SERVICE SHOP

By JOHN T. FRYE



THE WORM TURNS—AND SQUIRMS

MAC had to stop at the bank during his noon hour, so he was a little late getting back to his service shop. When he finally did step in out of the raw January wind, the outer office was empty; but he could hear Matilda Perkins, the office girl, giggling like a high school freshman back in the service department. Walking softly across to the door, he opened it upon a strange sight.

Barney, his assistant, was sitting cross-legged on the service bench, his red thatch of hair concealed beneath an improvised turban of paper towels. In his left hand he clutched a small, misshapen doll, and with his right hand he was repeatedly thrusting a sharp scribing tool into its soft body. All the while he kept muttering to himself in a low monotone. Matilda was perched on a service bench stool in front of him trying to stop her almost hysterical laughter by crumpling a handkerchief into her mouth.

"What's with Balmy Barney now?" Mac asked her.

"He's getting rid of his inhibitions," she managed to gasp.

"I never thought he had any," Mac said; "but how does all that help?"

"He read in a magazine that children often can be freed from their secret hates and angers by allowing them to deface and destroy pictures of people they dislike," Matilda explained, wiping her eyes. "He says if that's good for kids it ought to be good for him, too; so at noon he bought that kit of modeling clay and made that little man-figure that stands for all the manufacturers, engineers, and production men who dream up radio and TV sets that are hard to service. Now he's punishing this effigy and so ridding himself of a suppressed desire

to commit mayhem on the persons of these men."

"Sounds like witchcraft to me," Mac commented as he sat down on the other service stool and picked up a lump of the colored clay.

Like most good Irishmen, Barney Gallagher had a little of the ham (sock-and-buskin as well as key-and-mike variety) in him, and he was playing this scene to the hilt and way beyond—say about half-way to the elbow. He had sat silent with his chin on his chest like a brooding Buddha during this exchange between his boss and Matilda, but now he took up his sing-song chant again:

"So you will run leads from a set down through a hole in the cabinet shelf and then *solder* them to the speaker so a man has to use a soldering iron just to get the chassis out, will you? And how about that business of stapling loop antennas into console cabinets? Too cheap to use a couple of wood screws, aren't you? But when it comes to putting backs on console and TV cabinets you don't mind using screws. Oh no! Then you throw in one about every two inches so a poor guy has to take out a whole hatful of them just to change a tube. Speaking of antennas, my bucko, this job is for cementing a loop inside a plastic cabinet and then using short leads soldered to chassis connections so a party can't even pull out the chassis and turn it over without breaking those solid-wire leads. Why couldn't you fasten the loop to the chassis where it belongs? You knew that putting the chassis back into the case, into the field of the loop, would upset any alignment done outside; yet you made no provision for reaching the alignment screws with the set in

the cabinet. Another prize crock you have pulled is in mounting a loop with its turns wound in a horizontal plane. You certainly should know that the only way a customer can pick up any but the stronger vertically-polarized signals on that loop is to turn the set on its side.

"This gouge is for the crimes you have committed in the name of dials and dial-drives. Take the case of those transparent dial covers that are riveted to metal or celluloid backing plates with only room for the pointer to move in between. How do you think the technician is going to clean those dial covers? Do you think he is going to remove and put back all those eye-let rivets each time, or did you intend for him to replace the whole works every time the cover got dirty?"

"Another thing: are you trying to see how much you can overload a poor little dial cord? You rig up contraptions requiring the dial cord to turn the tuning condenser, work a slug-tuning assembly, move a pointer back and forth, and revolve forty-eleven pulleys besides—and sometimes you are too tight even to use wooden pulleys! You know that cord will start slipping on the shaft before the set is out of the store a month. If you can't make the thing work longer than that, how do you expect the technician to do so?"

"Take that and that for the things you have done with record changers! Only a bird with malice in his heart would ever design a changer that must maintain tolerances and clearances to a few thousandths of an inch and then make the thing out of warping, wearing pot metal. All you want to do is get the thing out of the factory. A lot you care if it is impossible to keep in adjustment in the field. You prove that again by cooking up a changer design that taxes every last ounce of power of the phono motor. When everything is clean and brand-new, the motor barely has enough power to complete the change cycle; but as soon as a little gum forms in it and the drive wheel loses a tiny bit of its traction, the motor no longer can do the job. You never thought of designing in a little reserve of power, I presume."

Barney stopped for breath, and Mac reached over and took the sharp-pointed scriber out of his hand.

"Let me try a little of this voodoo stuff," he drawled as he held up a little figure he had molded from various colored bits of clay while Barney was talking. "Now this little figurine stands for a few technicians I have known in my time and who have gotten into my hair more than somewhat in that period."

"The first sharp prick we give you, my friend," Mac said to the little clay doll, "is to deflate your ego. I often hear you heaping fine scorn on radio and television manufacturers for the mistakes they have made. You never give these men any credit for having

(Continued on page 101)



International SHORT-WAVE

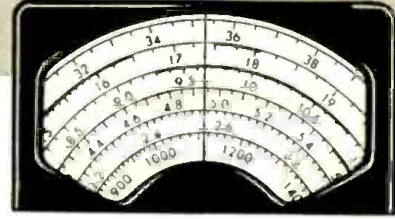

Compiled by KENNETH R. BOORD

THANKS go to Simon Scheiner, New Jersey, for this data which he received from officials of *Radio Republic Indonesia*, Djakarta, USI:

Overseas Service—YDF, 11.770, 100 kw., Djakarta (Java), beamed to India, Middle East, Europe (may be used during European winter); YDC, 15.150, 50 kw., Djakarta, beamed with Antenna 1 to Australia, Antenna 2 to China, Antenna 3 to India-Europe; YDB2, 4.910, 1 kw., Djakarta; YDB3, 7.270, 7.5 kw., Djakarta, beamed to Indo-China; YDE, 11.770, 7.5 kw., Djakarta, beamed to West Coast USA.

Home program in Indonesian—YDB, 2.260, 1 kw., Djakarta; YDB2, 4.910, 1 kw., Djakarta; YDF, 6.045, 100 kw., Djakarta; YDO, 9.585, 50 kw., Djakarta.

Second home program—YDD, 3.205, 1 kw., Djakarta; YDB3, 7.270, 7.5 kw., Djakarta; YDE, 11.770, 7.5 kw., beamed to Sumatra; YDE, 11.770, 7.5 kw., beamed to East Indonesia.

Other domestic outlets—YDA2, 2.415, 150 w., Bandung (Java); YDA, 3.390, 3 kw., Bandung; YDA3, 4.945, 150 w., Bandung; YDA6, 2.390, 100 w., Tjirebon (Java) is relay station for Bandung; YDJ, 7.060, 7.5 kw., Djogjakarta (Java); YDJ2, 7.100, 1 kw., Djogjakarta; YDJ3, 2.450, 300 w., Djogjakarta; YDG, 6.170, 3 kw., Surakarta (Java); YDG2, 2.300, 100 w., Surakarta; YDI, 3.240, 1.2 kw., Surabaya (Java); YDI2, 3.980, 5 kw., Surabaya; YDI3, 2.467, 300 w., Surabaya; YDH, 2.500, 150 w., Semarang (Java); YDH2, 3.945, 1 kw., Semarang; YDG6, 2.370, 300 w., Madiun (Java) which is relay for Surabaya; YDI6, 2.335, 300 w., Djember (Java) is relay for Surabaya; YDU, 4.840, 1 kw., Denpasar (Bali); YDQ, 3.365, 300 w., Makassar (Celebes); YDQ2, 9.550, 8 kw., Makassar; YDQ3, 7.295, 300 w., Makassar; YDR, 4.865, 1 kw., Ambon (Moluccas); YDR2, 2.420, 150 w., Ternate (Moluccas) is relay for Ambon; YDS, 3.230, 1 kw., Manado (Celebes); YDO, 3.380, 1 kw., Bandjarmasin (Borneo); YDO-2, 5.960, 1 kw., Bandjarmasin; YDN, 2.350, 300 w., Pontianak (Borneo); YDK, 4.855, 1 kw., Palembang (Sumatra); YDL2, 2.320, 300 w., Padang (Sumatra); YDL, 3.960, 1 kw., Padang; YDM, 3.270, 300 w., Bukittinggi (Sumatra); YDM2, 5.030, 1 kw., Bukittinggi; YDP, 4.930, 1 kw., Medan (Sumatra); YDP2, 3.350, 300 w., Medan; YDP3, 7.240, 7.5 kw., Medan; YDN, 2.390, 100 w., Kotaradja (Sumatra).

Radio Republic Indonesia officials

listed transmitting hours for the Home Service as weekdays 1730-1945, 2330-0215, 0430-1030; Sundays and holidays 1830-0215, 0430-1030. Overseas Service as 0600-0700 *English* for Australia (YDC) and Malaya (YDB2); 0700-0800 Chinese for China (YDC) and Malaya (YDB2); 0800-0900 Arabic for Southeast Asia (YDC, YDB2); 0900-0930 Urdu for Pakistan (YDC) and Malaya (YDB2); 0930-1030 *English* for India-Pakistan (YDC) and West Coast USA (YDE); 1030-1100 Hindi for India (YDC) and Malaya (YDB2); 1030-1130 French for Indo-China (YDB3) and Malaya (YDB2); 1100-1200 Arabic for Middle East (YDF7, YDC); 1200-1300 French for Middle East and Europe (YDF7, YDC); 1300-1400 Dutch for Europe (YDF7, YDC); 1400-1500 *English* for Europe, New Zealand (YDF7, YDC).

Radio Club Notes

Japan—The Japanese Short-Wave Club, P.O. Box 29, Sendai, Japan, is now issuing a monthly house organ that is entirely in the *English* language. Editors are Kenro Wada and

(Note: Unless otherwise indicated, all time is expressed in American EST; add 5 hours for GCT. "News" refers to newscasts in the English language. In order to avoid confusion, the 24 hour clock has been used in designating the times of broadcasts. The hours from midnight until noon are shown as 0000 to 1200 while from 1 p.m. to midnight are shown as 1300 to 2400.) The symbol "V" following a listed frequency indicates "varying." The station may operate either above or below the frequency given. "A" means frequency is approximate.

This young DX'er is Roland Engberg of Sweden. He is a contributor to the ISW DEPARTMENT and one of the "most valuable" contributors to "Radio Sweden's" DX program.



Akira Ogawa. Welcomes members from all over the world.

Sweden—QRA of Malmo Kortvagsklubb (The Malmo Short-Wave Club) is Fack 7026, Malmo 7, Sweden. This club's house organ, "Malmo DX-aren," is published in Swedish and *English*.

USA—The Universal Radio DX Club, 21446 Birch St., Hayward, Calif., observed its 19th anniversary when it issued its December 1 bulletin.

The amended by-laws and constitution of the Newark News Radio Club have been compiled in attractive booklet form by Peter J. McKenna, Albuquerque, New Mexico, vice-president, and the publication has been sent to all members of the club. James J. Hart, former short-wave editor for NNRC, headed up the By-Laws Committee. Your *ISW DEPARTMENT* editor recently was honored with a "Member of the Month" citation from NNRC.

This Month's Schedules

Afghanistan—Radio Kabul, 9.975, is noted weekdays around 1135-1150; on Sundays extends sessions with a listeners' request program to around 1215. Wishes to receive reception reports; hopes soon to put in two new high-powered transmitters; is trying to trace sources of QRM to present 9.975 channel. (Pearce, England) Reports may be sent to Director of English Programs, Kabul Radio, Post Box 24, Kabul City, Afghanistan, or to Edris Ali Shah, London Agent, Kabul Radio, 134, Fellows Road, London, N.W. 3, England. (ISWC, London) Kary, Pa., has received word from the London Agent that the station hopes to have "at least one 100-kw. transmitter" in use before long.

Albania—Radio Tirana, 7.852A, has strong signal ending broadcast in French, 0100, then closes down. (Pearce, England) Is heard in USA now with news 2345. (Stark, Texas, others) And is sometimes audible to fair during 1600 news. (Kary, Pa.)

Algeria—Radio Algerie has moved from 6.145 to 6.160 for Arabic transmissions; heard sometimes to around 1800. (Kary, Pa., others) Niblack, Ind., notes the 9.57 outlet 1730-1800 with French session.

Andorra—Radio Andorra, 5.990, noted 1730 when identified in Spanish. (Croston, Pa.)

Anglo-Egyptian Sudan—Radio Omdurman sent schedule as Arabic 2315-
(Continued on page 82)

Fig. 1. Front cabinet view of home-built audio oscillator. The dial scale on author's unit is nonlinear in the interest of simplicity but may be made linear.



A low-cost

AUDIO OSCILLATOR

By C. R. GERBER

This unit, housed in a 5" x 6" x 9" box, uses standard parts, covers 20 cps to 200 kc. in four ranges, and requires no re-calibration.

THE second instrument the average electronic experimenter finds necessary in his hobby (the first is a good v.t.v.m.) is usually a variable audio oscillator. The usefulness of a good audio oscillator is hard to overrate; it can be employed for tasks as mundane as determining frequency response; as expedient as code-practice signal, or variable b.f.o.; as unusual as determining the operating time or contact bounce of relays. Unfortunately, a really good oscillator costs money. Almost equally important for the apartment-dweller, it is large and difficult to store in the hall closet.

The desire being felt, and the major conditions known (lack of space, lack of money), the only way out was to design and build an oscillator with whatever could be begged, borrowed, or salvaged. Optimistically, it was to be the equivalent in performance of a certain well-known laboratory standard. Blissfully confident in what luck and sweat could do, a list of specifications was set up as follows: 1. Cost—as close to nothing as possible; 2. Size—to be housed in a 5 x 6 x 9 inch box; 3. Range—20 cps to 200 kc. in four decaded ranges; 4. Stability—zero drift under any conditions; 5. Distortion—zero; 6. Amplitude—constant; 7. Components—non-precision; and 8. Calibration—one-time only.

Despite the optimism, the resulting circuit to be described comes surprisingly close to the ideal. Two of these instruments were constructed initially and have been in operation for over a year; a third was recently bread-boarded by a very critical engineer and checked by means of a CRO against a commercially-built oscillator guaranteed to have less than 1/2% harmonic distortion. There was no

measurable distortion in the bread-board circuit. (This method of checking distortion will be described later for those interested.)

During the developmental period a number of different circuits were constructed and tested, including the heterodyne, the phase shift, the bridged-T, and the Wien bridge circuits. All of these have been described at one time or another in this magazine. Without discussing the "whys" and "why-not's," the circuit used was a modified Wien bridge, with a dual 10,000 ohm potentiometer as the variable element.

To anyone familiar with v.f.o.'s the previous sentence packs a whale of a lot of information. In the first place, textbooks and constructors alike frown on the dual or triple pot. as a frequency-varying element, principally citing the non-tracking characteristic of such pots, with variation with age and temperature running a close second. Let it be said once and for all that the non-tracking bugaboo is seriously overrated; in this circuit the resistances have been deliberately unbalanced by 5% with no change in amplitude or waveform, and only a slight shift in frequency.

Fig. 2. Characteristic of a 3-watt, 117-volt bulb. The bulb acts as a feedback control.

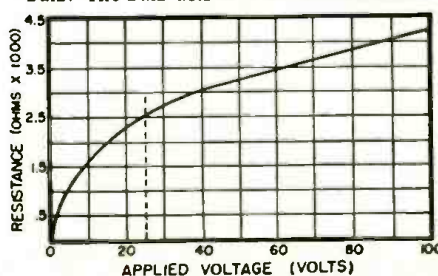

Since the device must be calibrated in any event, this is no drawback. This highly-touted warning is the result of trying to use high-resistance carbon pots.; use of a low resistance, wire-wound unit sidesteps this difficulty.

The small value of resistance adds one very important feature: stability. To tune the 20-200 cps range, 1.2 μ f. is needed. As many radio amateurs know, the stability of an LC-tuned circuit is inversely proportional to the LC ratio, for condensers are by nature more stable elements than coils. The situation is precisely similar for RC nets. Most commercial oscillators for the audio ranges use RC nets for the tuning element, employing 4-gang variable condensers. Hence, it may be observed that the frequency shifts when the hand is brought near the dial, unless the instrument is unusually well shielded. The circuit being discussed is so stable that a finger may be placed on the oscillating grid without disturbing the frequency.

Also in the key statement lies the limitations of this circuit; use of a linear pot. as the variable element means a very nonlinear dial calibration. There are two electrical methods known to the author to minimize this, and one mechanical makeshift which will not be discussed. Neither method was employed in the initial instrument, and it has operated so satisfactorily that no effort has been made to alter the circuit.

Theoretically, the limiting high frequency of this circuit occurs when the inductive reactance of the pot. becomes an appreciable fraction of the total impedance; practically, however, extreme care is required to reach 2.0 mc., with 200 kc. as an easily obtained value. Above this frequency the am-

plitude falls off due to the increasing shunting effect of tube and wiring capacitance. With the tubes and circuit constants indicated, 1.0 mc. represented the upper limit, and the completed unit was not extended beyond 200 kc.

The circuit and component values are shown in Fig. 3. Figs. 5 and 6 show top and bottom views of the completed unit without the case to indicate the parts layout. The tuned-circuit condensers are in the shielded box at the rear of the chassis. The layout is not critical unless the extreme range of frequency is desired. Likewise, none of the components are precision. However, if single-dial calibration is desired, the condensers must be hand-picked. Don't let this discourage you; when constructing the two original units selection was made from standard-value condensers. Five each of the 1.0, 2.0, and 5.0 values from 100 μ fd. to 1.0 μ fd. were obtained and measured on a capacitance bridge. Two sets of decaded pairs, matched within $\frac{1}{2}\%$ in pairs and 1% in decades were assembled. An illustration of the method follows:

Nominal:	1.000	0.200	0.010
Measured:	1.012	0.220	0.0115
	1.004	0.217	0.0110
	0.982	0.195	0.0102
	0.980	0.191	0.0096
	0.977	0.188	0.0089

These values were from a random selection of five as taken from stock; note that the measured values are both above and below the nominal value, and vary as much as 20% from the nominal value.

For a 10,000 ohm pot., and a dial of exactly 180 degrees rotation, 6666 ohms is the maximum resistance to be used, corresponding to 20 cps. The necessary value of capacitance is then 1.200 μ fd. Therefore two 1.200 μ fd. condensers must be assembled. Examining the list, the following possible combinations will work:

A	B	C	D	E
1.012	1.004	0.982	0.980	0.977
0.188	0.195	0.217	0.220	0.220
1.200	1.199	1.199	1.200	1.197

Of these, A and D are the obvious choice, with B and C as second choice. However, A and B could be used together with only 0.1% unbalance, and even the worst case of A and E would result in only 0.3% unbalance—which is notably better than the 1% to be expected from precision condensers costing five times as much. The other decade values are built up in the same manner, always trying for the best balance between pairs, and accurate decading. Usually such balance can be obtained with two condensers each, as demonstrated, although in some cases a third may be necessary. If more than three are required, try some other combination.

Now this is work, but mainly paper work, juggling the measured values until the desired precision is attained. A capacitance bridge such as the *General Radio* capacitance bridge is a necessity, and the use of one can usually be obtained from a local firm, technical school, or university. A total of sixty

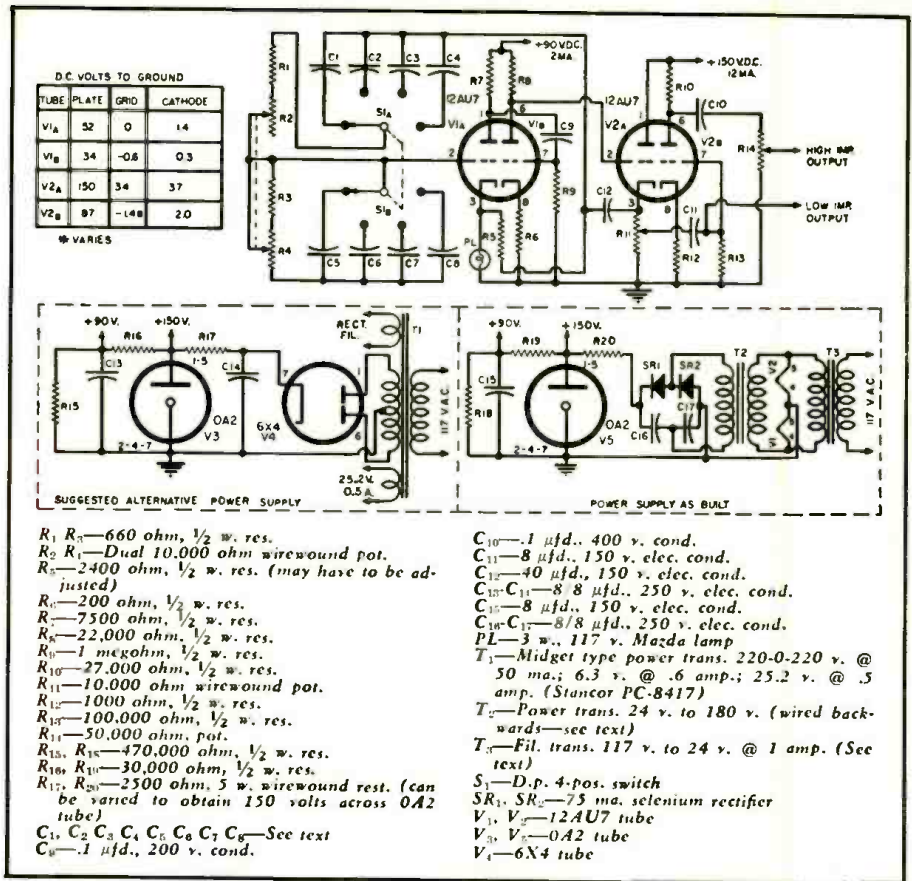

Fig. 3. Complete circuit diagram covering the low-cost audio oscillator.

condensers of standard values is still considerably less expensive than precision components, and those not selected can be used in other applications less stringent in their requirements.

The basic value of capacitance (1.2 μ fd. in the previous example) is set by the maximum resistance and the dial angle desired. In the original model, 1.2 μ fd. was the basic value since 180-degree coverage was desired, using a 10,000 ohm pot. The potentiometer winding covered 300 degrees; 180 degrees corresponds to 6000 ohms. Since this is the maximum resistance of the pot. that will be used, it corresponds, in turn, to 20 cps. With zero pot. resistance, the dial will have covered 180 degrees, and this must correspond to 200 cps. Of course for 200 cps and a 1.2 μ fd. condenser, the resistance must be 600 ohms. This must be a fixed resistor in series with the potentiometer. The total resistance for 180-degree rotation will then be 6000 plus 600, or 6600 ohms. This, in turn, makes the fixed resistor value 660 ohms—this see-saw could be continued as far as desired. To a reasonable percentage of accuracy, the fixed resistor should be 666 ohms, and 6666 ohms as the total resistance at 180-degree rotation. The value of capacitance is then found to be 1.2 μ fd., which has a reactance of 6660 ohms at 20 cps.

It should be pointed out that it is not necessary to use this exact value of capacitance if a dial angle of slightly more or less than 180 degrees

is permissible, nor if the decaded frequency can be other than 20 cps. In fact, the second unit constructed was based on a 18 cps decade, since of the original five sets of condensers a second matched pair of 1.200 μ fd. could not be constructed easily after the first pair has been removed. The basic value of capacitance for this oscillator was 1.34 μ fd. Also, the linear pot. is not necessary; in fact a nonlinear pot. would be an advantage in rectifying the dial spacing. Finally, the 10 to 1 decading is not essential; a 3-to-1 span would be considerably better as far as dial spacing is concerned. This means twice as many condensers and switch points, but the added cost is small if the nonlinear dial is a particular disadvantage. The method outlined can be applied just as easily with these modifications in the design. The purpose of this article is not so much to describe one particular design as to outline methods of designing an oscillator to fit the user's individual needs and desires.

The extreme stability afforded by a low-impedance tuning circuit has an attendant disadvantage. A glance at the circuit shows a two-stage RC-coupled amplifier with connecting positive and negative feedback loops. The difficulty appears when trying to couple the low-impedance positive feedback circuit to the plate of the second tube. The low-impedance value is had enough, although this may be overcome by proper design; however, adding a 10 to 1 variation in impedance (frequency) causes an amplitude

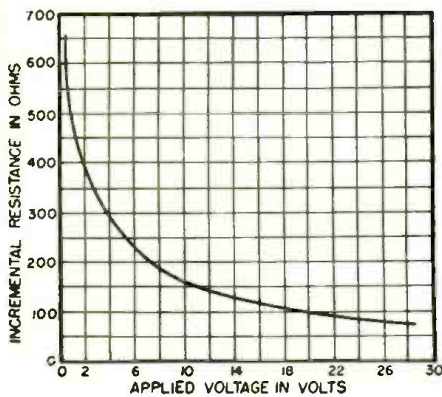

Fig. 4. Curve showing incremental resistance which governs action of the 3-watt lamp.

variation of 20 db. Without a complex circuit addition, it is impossible to hold the oscillator output even reasonably constant. The amplitude-constant feature is the function of the 3-watt lamp in the cathode circuit of the first tube, representing a variable resistive element. But it will perform this function over a very limited range of voltage—more like 3 db than 20 db. Therefore a means had to be developed to keep the oscillator output reasonably constant *before* the feedback lamp added its correction. The means developed makes the oscillator a usable instrument, and adds a second feature of a low impedance output with no extra complexity. The means referred to is the insertion of a cathode-follower after stage two, taking the feedback loops around the cathode follower, stage three. At the same time the cathode resistance of this stage is made a potentiometer, the arm of which is the low-impedance

output tap (approximately 500 ohms) and also acts as a vernier control for stage four. The last stage is merely an amplifier, and serves no other function. The output from the low impedance tap is 3.0 volts r.m.s., maximum; over 20 volts r.m.s. is available at the high impedance output, with an impedance of approximately 25,000 ohms.

The cathode follower, with an output impedance of less than 500 ohms, will allow a load variation (the tuned circuit) of from $R_L = \infty$ to $R_L = 500$ ohms before the amplitude decreases to $\frac{1}{2}$, which is 6 db, voltage-wise. The feedback lamp can now handle the remaining correction; amplitude is constant ± 2 db, from 20 cps to 200 kc.

The tubes used require no selection—in fact, almost any triode will operate as the oscillator—a 12AU7 is specified, but a 12AX7 may be used with a slight change in the feedback resistance. To take advantage of the amplitude stability of this circuit, a regulated power supply is desirable, most easily accomplished with a VR tube. The current drain is surprisingly low, so that the oscillator may not need a separate power supply. However, for those who desire a self-contained unit, two circuits are suggested in Fig. 3. The first employs a 6X4 tube, plus transformer and filter. The second is more compact, being a full-wave voltage doubler with double transformer isolation from the line. Two 6, 12, or 24 volt transformers are operated with the low-voltage windings interconnected, the two 12-volt tube filaments being appropriately connected. The "B" voltage is derived from the high-voltage side of the reversed transformer. This arrange-

ment permits grounding one side of the "B" supply, and one point of the filament string, and provides very effective shielding from spurious noise voltages generated on the 117-volt power line, as well as keeping the oscillator signal off the line. Although this point is seldom mentioned by most authors, it is surprising how an audio signal can ooze its way along the power line to some other device operated on the same branch.

Transformers T_2 and T_3 used in the actual construction of the oscillator were specially-built units that were on hand. As far as it was possible to determine, there are no direct replacements for these units. For transformer T_3 the commercial unit which comes the closest to meeting the specifications is the *Stanco* P-6469. Its rating is 117 volts primary to 25.2 volts @ 1 amp. secondary. This is slightly higher than the 24 volts desired but can be used directly without difficulty.

Transformer T_2 is not replaceable. If you are in a position to do so, you could have the transformer built to your specifications. It is possible, however, by removing turns, to use the same transformer as is used for T_3 . In reworking this transformer, remove a sufficient number of turns from the low-voltage winding until the required 180 volts are obtained across the high-voltage winding. When checking this voltage, it is advisable to connect the transformer in the circuit as shown in Fig. 3. This removal of turns requires some skill and, in the event that the transformer used is not conservatively rated, may cause overheating.

Because of this "custom" aspect, it is recommended that the alternative
(Continued on page 123)

Fig. 5. Top chassis view of the home-built audio oscillator.

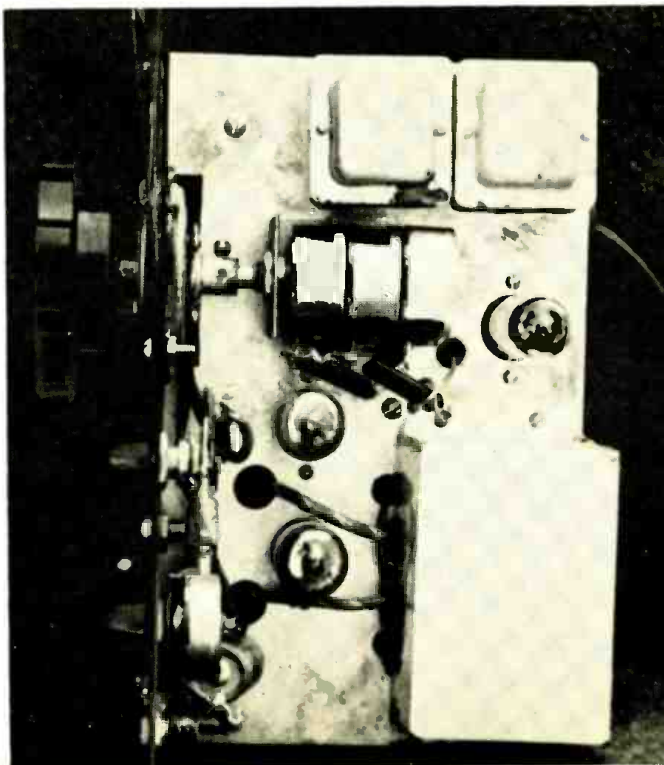
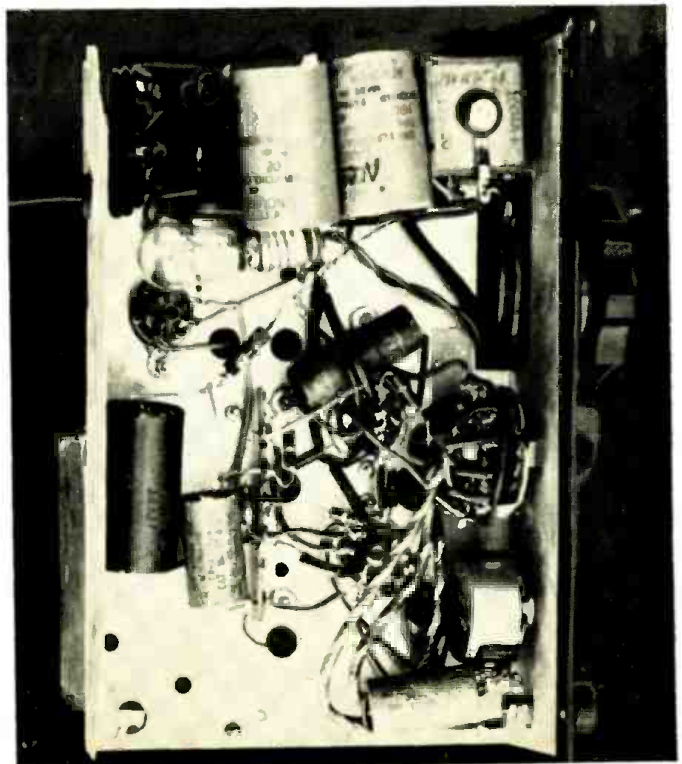
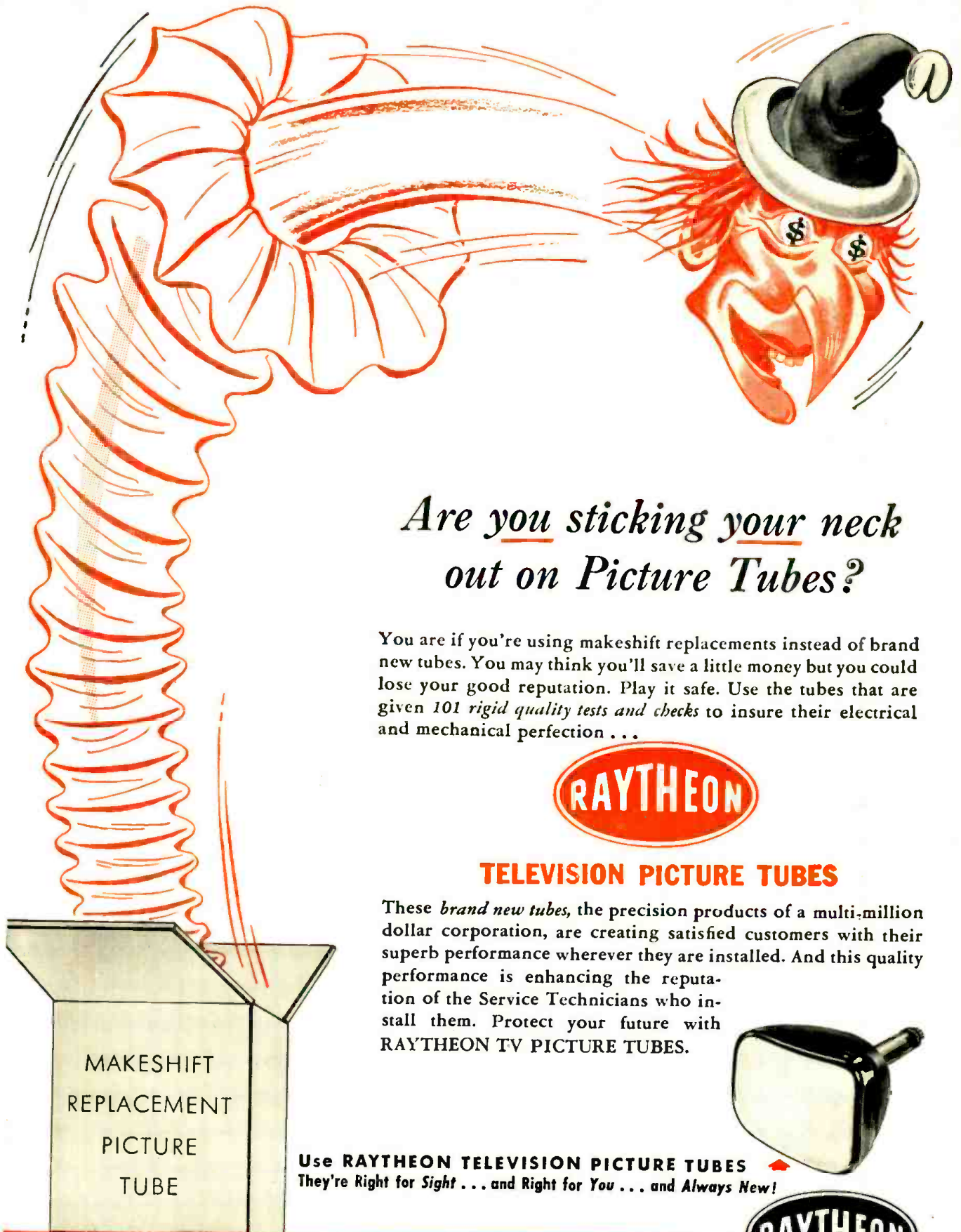

Fig. 6. Bottom view of unit showing layout of component parts.





Are you sticking your neck out on Picture Tubes?

You are if you're using makeshift replacements instead of brand new tubes. You may think you'll save a little money but you could lose your good reputation. Play it safe. Use the tubes that are given *101 rigid quality tests and checks* to insure their electrical and mechanical perfection . . .



TELEVISION PICTURE TUBES

These *brand new tubes*, the precision products of a multi-million dollar corporation, are creating satisfied customers with their superb performance wherever they are installed. And this quality performance is enhancing the reputation of the Service Technicians who install them. Protect your future with RAYTHEON TV PICTURE TUBES.



Use RAYTHEON TELEVISION PICTURE TUBES
They're Right for Sight . . . and Right for You . . . and Always New!



RAYTHEON MANUFACTURING COMPANY

Receiving Tube Division
Newton, Mass., Chicago, Ill., Atlanta, Ga., Los Angeles, Calif.

Excellence in Electronics

RECEIVING AND PICTURE TUBES • RELIABLE SUBMINIATURE AND MINIATURE TUBES • GERMANIUM DIODES AND TRANSISTORS • NUCLEONIC TUBES • MICROWAVE TUBES

RIDER TEK- FILE*

easy-to-use
packaged
tv
service
information—
it's
complete...
accurate...
factory-
authorized—
at
your
jobbers
now...
only
\$2 per pack

*dependable replacement parts listing beginning with Pack 57

JOHN F. RIDER
PUBLISHER, INC.

480 Canal Street,
New York 13, N. Y.

25-WATT UTILITY UNIT

By

GEORGE ANGLADO

Details on a versatile ham item that can be used as a crystal oscillator, straight amplifier, or a doubler.

HERE'S a neat little unit that the author built about two years ago which is still giving good service. The unit can be used as a 20-watt crystal oscillator on 160, 80, or 40 meters or it can be used as a 25-watt straight amplifier on any amateur band from 10 to 160 meters, or it may be used as a 20-watt frequency doubler on any band from 10 to 80 meters.

When used as an amplifier, the unit may be either link-coupled or capacity-coupled to the exciter tank. When used as a crystal oscillator, the crystal is plugged into the two socket holes as indicated in Fig. 1. The same two connections are used when the unit is capacity-coupled. The coils incorporate a jumper so that when one is plugged into the grid socket the tuning condenser (the 100 μ fd. mid-ge) is cut into the circuit.

We have used ready-made plug-in coils of the 50-watt, end-link type and have added the jumper to these units. Duplicate coils are not required for the grid and plate as the plate tank makes use of the coil designated by the manufacturer as being usable on the next higher frequency band (except on 10 meters). This provides a higher value of "Q" in a single-ended plate tank circuit. On 10 meters a "10-meter" coil is used in the plate circuit since a "5-meter" coil requires an excessive amount of capacity to hit 10 meters. For operation on all bands from 10 to 160 meters, two 10-meter

coils would be required but only one coil is required for each of the lower frequency bands.

Because of the small diameter of the coils, coupling can be kept to a minimum by spacing them far enough apart. Electrostatic coupling between the grid and plate circuits is prevented by a shield baffle which supports the 807 socket.

When the unit is used as a crystal oscillator there is not sufficient feedback to support oscillation except, possibly, on 40 meters. Thus when the unit is to be employed as an oscillator a small piece of wire must be tied to the grid prong of the 807 and run over the shield partition toward the top of the 807 for a distance of about 3 inches. More feedback coupling than that required to support stable oscillations should not be used on any band since excessive feedback capacity will result in a high value of r.f. crystal current.

Sufficient cathode bias is provided to limit the plate current to a safe value when no excitation is applied. This permits the unit to be used as an r.f. amplifier after a keyed oscillator or v.f.o.

The unit can be plate-screen modulated with excellent results. The only requirement is that there be sufficient excitation and that the 807 is not too heavily loaded. This latter restriction applies particularly when modulating the unit as a frequency doubler. —30—

Fig. 1. Complete schematic diagram and parts list for the 25-watt utility unit.

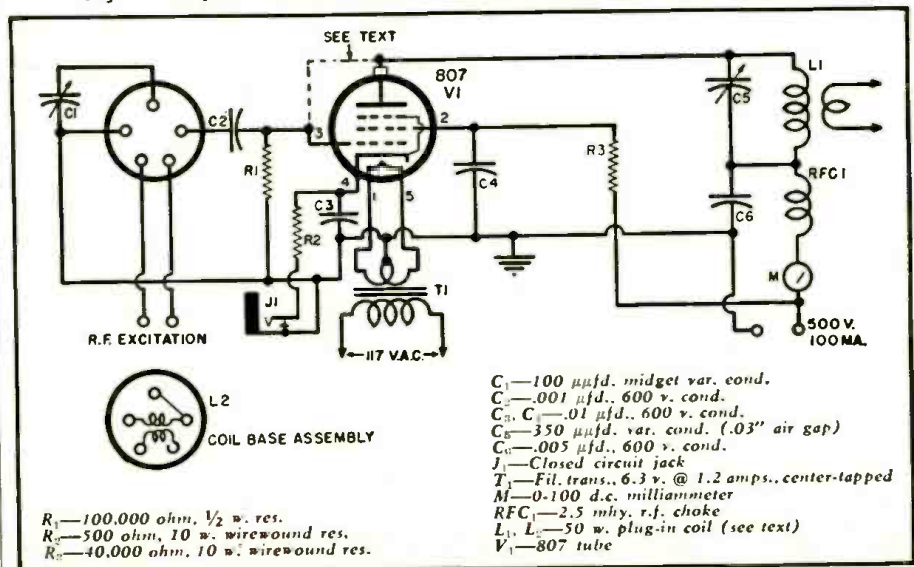

Check these ADVANTAGES FOUND Only in HEATHKITS

1



2



3



4



5



6

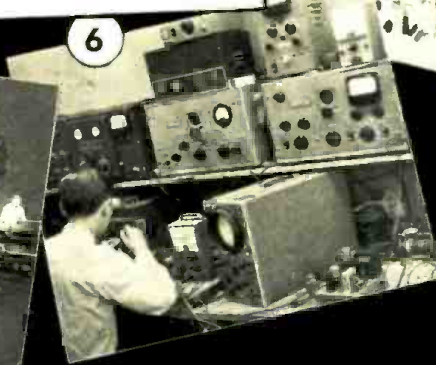

9



8



7



- ✓ **1. Baked Enamel Lifetime Finish Panels** — Oven baked finishes for maximum durability and freedom from marks, scratches and discoloration. Panels that can really take service shop and laboratory abuse.
- ✓ **2. Save Money** — You save all expensive factory wiring costs when you build your own. And, direct factory to customer sales eliminate all middle man profits. You can have a complete Heathkit laboratory or service shop for what one or two pieces of ready built equipment cost.
- ✓ **3. Modern Styling** — New "fitted panels" and formed cabinets with rounded corners present a smart, professional appearance. Dignified appearance for prestige.
- ✓ **4. Quality Components Used Throughout** — Heathkits use well known, time and quality tested components such as Simpson, Chicago Transformer, Wilkor, Allen-Bradley, Altec-Lansing, Centralab, Cinch, Oak, Grigsby-Allison, Mallory and many others.
- ✓ **5. Extensive Factory Facilities** — Shearing, punching, forming, spot welding, etc. is done right in our own plant — controlled production for highest quality and less cost to you.
- ✓ **6. Extensive and careful engineering** — A staff of engineers working in a modern, well equipped laboratory carefully develop Heathkits according to highest engineering practices. Your assurance of accurate, up to the minute instruments.
- ✓ **7. Complete Kits** — All the parts are right in the kit — you get all tubes, controls, transformers, meters — everything — no other components to buy. And no cutting, punching, or painting necessary — it's all done for you. Heathkits go together easily and smoothly.
- ✓ **8. Only Complete Line** — Over 30 kits available — Heathkits form the only complete line of kit-form test equipment on the market. Kits for hams, engineers, service men, schools and audio enthusiasts.
- ✓ **9. Detailed, Complete Instruction Manuals** — Comprehensive manuals tell you exactly how to build your Heathkit. Manuals contain easy-to-follow instructions, clear, large pictorials, schematic, detail drawings, etc. They make construction easy, fun, and educational.

Nine New Heathkits This Year!

EXPORT AGENT
ROCKE INTERNATIONAL CORP.
13 E. 40th ST.
NEW YORK CITY (10)
CABLE: RR148 N.Y.

The HEATH COMPANY

... BENTON HARBOR 15, MICHIGAN

NEW Heathkit "Q" METER KIT

• A HIGH QUALITY Q METER AT LOW COST.

MODEL QM-1

SHIPPING
WT. 2 LBS.

\$39.50



Measures Q and inductance of coils.



Measures Q and capacity of capacitors.

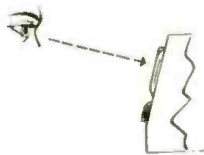

Slant face cabinet for ease in reading the meter.



• First Q METER within the price range of all.

• Read Q's of 0-500 directly on calibrated scale.

• Stable oscillator supplies R.F. frequencies of 150 kc to 18 megacycles.

• Calibrated capacitor with range of 40 mmf to 450 mmf with vernier of ± 3 mmf.

• Simple, easy operation.

• Can be used to measure small inductances or capacitors.

• Measures Q of condensers, RF resistance and distributed capacity of coils.

• Measures capacity by substitution, capacity by resonance, inductance by resonance.

• Slanted panel for convenient operation.

Another outstanding example of progressive HEATHKIT engineering. Now a highly desirable Q METER within the price range of all laboratories, schools and experimenters. No longer is it necessary to deny yourself the many measurement advantages offered by this instrument.

Use the new HEATHKIT Q METER for the following simple basic measurements: capacity by substitution, capacity by resonance, inductance by resonance and Q at the OPERATING frequency all can be read on the calibrated scales. The method used to obtain information regarding the Q of condensers, RF resistance, distributed capacity in coils, etc., is only slightly more involved. In the HEATHKIT Q METER, the generated RF signal is coupled through a cathode follower and injected across a low impedance condenser which is included in the resonant circuit under test. Large $4\frac{1}{2}$ " 50 microampere Simpson meter reads Q directly. The resonating condenser and vernier condenser are calibrated in mmf for substitution method capacity tests. The resonating condenser is also calibrated in effective capacity for resonance tests. The inductance calibration serves for rapid determination of the approximate inductance of a coil. The HEATHKIT Q METER has a generator frequency range of 150 kc to 18 megacycles. Vernier capacity covers ± 3 mmf and the resonating condenser is calibrated from 40 mmf to 450 mmf actual capacity or 40 mmf to 350 mmf effective capacity. Meter reads Q directly up to 250. Higher and lower full scale readings can be obtained by varying the injection voltage levels.

The entire kit consists of 12AT7, 6AL5, 6C4, OD3 and 6X5 tubes. 50 microampere Simpson meter, power transformer, cabinet and all other parts necessary for construction as well as instructions for assembling, testing and operation of the completed instrument.

Heathkit DECADE RESISTANCE KIT

The HEATHKIT DECADE RESISTANCE KIT is widely used by schools, experimenters and laboratories because of the extremely wide resistance range offered and the useful, dependable service provided. The DECADE consists of 5 rotary 2 deck ceramic wafer switches with silver plated contacts and twenty 1% precision resistors in a circuit which provides the resistance range of 1 ohm to 99,999 ohms in 1 ohm steps. The HEATHKIT DECADE RESISTANCE KIT is simple to construct and is housed in a beautiful polished birch cabinet with an attractive panel. The DECADE will furnish years of accurate trouble-free service.

Individual decade sections of above can be purchased separately for special applications.



MODEL DR-1
SHIPPING
WT. 4 LBS.

\$19.50

NEW Heathkit DECADE CONDENSER KIT

Extremely useful in all experimental and design work such as determination of condenser values for: compensating networks, filters, bridge impedances, tuned circuits, etc. Uses all precision silver mica condensers within $\pm 1\%$ accuracy. Values run in three decades from 100 MMFD to 0.111 MFD in steps of 100 MMFD. Smooth acting, positive detent, highest quality ceramic wafer switches make all capacitor values easy to set up and keep losses to a minimum. Low loss dielectric terminal board mounts on outside of panel for easy cleaning. Heathkit binding posts accommodate a wide variety of test leads. Comes complete with all parts, including polished birch cabinet.

Individual decade sections of above can be purchased separately.



MODEL DC-1
SHIPPING
WT. 4 LBS.

\$16.50

EXPORT AGENT
ROCKE INTERNATIONAL CORP.
131 E. 40th ST.
NEW YORK CITY (16)
CABLE APRAE-N.Y.

The **HEATH COMPANY**

... BENTON HARBOR 15, MICHIGAN

NEW *Heathkit* OSCILLOSCOPE KIT

• NEW WIDE BAND VERTICAL AMPLIFIER ± 2 DB 10 CYCLES TO 1 MC.



Direct plate connections for modulation tests.



Displays TV sync pulses correctly.



Useful to 5 mc.



Good square wave response at 100 kc.

MODEL O-8

SHIPPING
WT. 29 LBS.

\$43.50

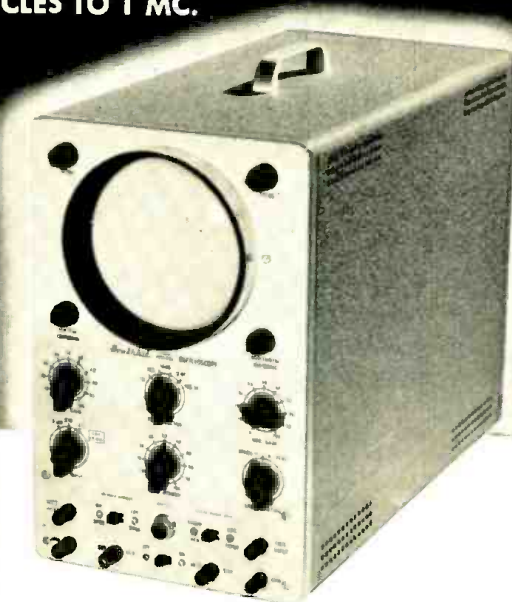

- New wider band vertical amplifier ± 2 db from 10 cycles to 1 megacycle useful to over 5 megacycles.

- High sensitivity in vertical amplifier, .025 volts RMS per inch deflection.

- New 3 step input attenuator input ranges X1, X10, X100.

- New 5CP1 intensifier type tube for greater brilliance.

- Terminal board and rear cabinet opening provisions for direct connections to deflecting plates.

- Newly styled formed and ventilated aluminum cabinet.

- Wide band sweep generator, 15 cycles to over 100 kc. Will synchronize with 5 megacycle signal.

- 10 tube circuit featuring push pull operation of vertical and horizontal amplifiers.

- Internal synchronization on either positive or negative peaks.

- Reproduces faithfully the front and back porches of TV sync pulses. Excellent square wave reproduction to over 100 kc.

- Optional Intensifier kit available for 2200 volt operation.

Proudly announcing the new 1953 HEATHKIT Model O-8 OSCILLOSCOPE featuring the finest performance ever offered in this extremely popular kit instrument. Improved wider band vertical amplifier featuring a new 3-step input attenuator affording smooth control of the excellent .025 volts per inch vertical sensitivity. Possibility of overloading the vertical input circuit is minimized. Greater band width in the vertical channel is a decided advantage to TV service men. Permits clear observation of all TV sync pulse detail and excellent square wave reproduction over 100 kc. 5CP1 intensifier type CR tube provides a brilliant trace with normal accelerating voltages. A handsome, ventilated cabinet with smooth rounded corners and a snug fitting drawn panel adds to the smartly styled professional appearance. Longer life is assured through cooler instrument operation. Push pull output stages in both vertical and horizontal amplifiers for balanced deflection of the spot. All of the many fine features of the previous model have been retained. Rear cabinet access to terminal board for direct connection to CR plates. The entire kit of all 10 tubes, parts, cabinet and panel as well as detailed construction manual for assembly and operation of the instrument included.

INTENSIFIER KIT: For extreme trace brilliance in special applications such as photography, group demonstrations or operation in brightly lighted areas an optional Intensifier kit providing 2200 volt operation of the CR tube is available. Kit includes high voltage filter condenser, high voltage selenium rectifier, etc. \$7.50.



Heathkit

SCOPE DEMODULATOR PROBE KIT

Trouble shooting or aligning TV, RF, IF and video stages requires demodulation of high frequency signals before Oscilloscope observation. The HEATHKIT SCOPE DEMODULATOR PROBE KIT was specifically developed for this application. Kit consists of a probe housing, crystal diode detector circuit, shielded cable and spade lugs. Assembly is simple and the probe will quickly prove its usefulness as an Oscilloscope accessory.

No. 337
SHIP. WT. 1 LB.
\$4.50

NEW *Heathkit* VOLTAGE CALIBRATOR KIT

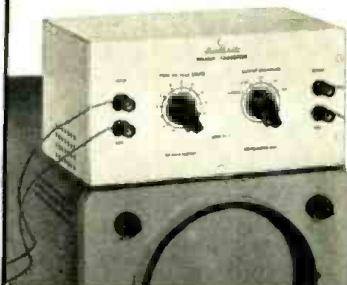

MODEL VC-1
SHIPPING
WT. 5 LBS.

\$9.50

Use the Heathkit Voltage Calibrator with your oscilloscope to measure peak-to-peak TV complex waveshapes. TV manufacturer's specifications indicate correct peak-to-peak voltages and this kit will permit making these important measurements.

A big help to engineers in circuit work. Makes peak-to-peak voltage measurements of complex waveshapes of all kinds. Flat topped semi-square wave output of calibrator assures fast and easy measurement of any voltage between .01 and 100V peak-to-peak.

The Voltage Calibrator can remain connected to your oscilloscope at all times for instant use. "Signal" position connects signal under study directly through calibrator and into scope input circuit for direct observation. Eliminates transferring leads from calibrator. *A wonderful scope accessory.*

Heathkit ELECTRONIC SWITCH KIT



MODEL S-2
SHIPPING
WT. 11 LBS.

\$19.50

A few dollars spent for this accessory will increase the usefulness of a scope immeasurably. An electronic switch will open up a whole new field of scope applications for you. The S-2 allows TWO SIGNALS to be observed at the SAME TIME — this important feature allows you to immediately spot phase shift, clipping, distortion, etc. The two signals under observation can be superimposed or separated for individual study. Each signal input has an individual gain control for properly adjusting scope trace patterns. Has both coarse and fine frequency controls for adjusting switching time. Multivibrator switching frequency is from less than 10 cps to over 2000 cps in three overlapping ranges. Kit comes complete including 5 tubes, power transformer, all controls, instruction manual, etc. *Every scope owner should have one!*

SOLE AGENT
ROCKE INTERNATIONAL CORP.
13 E. 40th ST.
NEW YORK CITY (10)
CABLE: ARAD NY

The **HEATH COMPANY**

... BENTON HARBOR 15, MICHIGAN

Heathkit
VACUUM TUBE

VOLTMETER KIT

• NEW 1½ VOLT RANGE ON 1953 VTVM.

MODEL V-6

SHIPPING
WT., 7 LBS.

\$2450

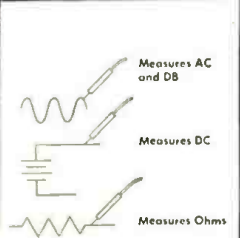
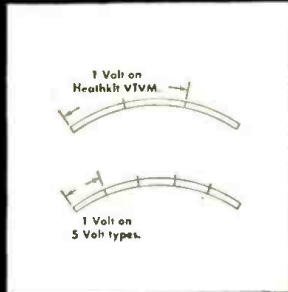
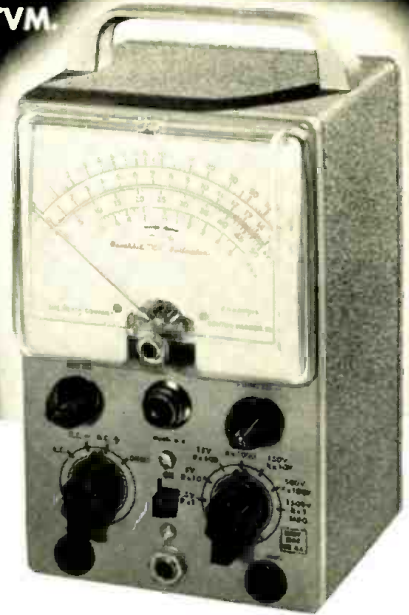

- New 1½ volt low range gives over 2" of scale per volt instead of less than ¾" found on 5 volt range type.
- Increased accuracy due to expanded scales.
- New 1500 volt DC high range gives 50% greater coverage.
- Seven ranges in all. 1½, 5, 15, 50, 150, 500 and 1500 volts DC (1000 volts maximum AC only).
- Provides proper service ranges 150 volts for AC DC work and 500 volts for AC type service.
- High input impedance, 11 megohms minimizes circuit loading.
- Variety of accessory probe kits available.
- 1% precision resistors in multiplier circuits.
- 200 microampere Simpson meter.
- Center scale zero adjust.
- Transformer operated.
- Test leads included.
- New cabinet styling.
- Large, clearly marked meter scales indicate ohms, AC volts, DC volts and DB.

The 1953 Heathkit V-6 VTVM has improved ranges! The lowest range has been moved way down to 1.5V full scale. This gives 3½" of actual scale length for the 1.5V covered — that's 2½ inches per volt!! Now you can make your low level measurements faster and with greater accuracy.

And the upper range has been moved up. Readings up to 1500V DC can be readily made with new, improved VTVM — plus readings up to 1000V on AC. Higher ranges for extended use.

New vertical chassis mounting gives added chassis space for really easy wiring — no tight corners to worry about. Uses only highest quality components throughout. Simpson 200 microampere meter movement combined with 1% precision resistors in multiplier circuit insure highly accurate and dependable readings.

AC and DC voltage ranges are 0-1.5V-5V-15V-50V-150V-500V-1500V. (1000V max. reading on AC) — a total of seven ranges for convenient, accurate readings. Instrument also measures resistance from .1 ohm to over 1 billion ohms in seven handy ranges of RX1, X10, X100, X1000, X10K, X1 Meg., — all convenient multiples of 10 with no skips. Has Db scale in red for easy identification.

New panel has tough baked on enamel finish for freedom from scratches and maximum durability. Modern styled, formed, compact cabinet with rounded edges and crackle finish is truly handsome.

Comprehensive, detailed instruction manual with step-by-step instructions, figures, pictorials, etc. makes assembly a cinch.

Be sure and look over the special accessory VTVM probes below — for added usefulness.

Heathkit R. F. PROBE KIT
SHIP. WT. 1 LBS. \$5.50
No. 309
Extends RF range of HEATHKIT 11 megohm VTVM to 250 megacycles ± 10%.

Heathkit 30,000 V. D.C. PROBE KIT
SHIP. WT. 2 LBS. \$5.50
No. 336
Provides DC multiplication factor of 100 for any 11 megohm VTVM.

Heathkit PEAK TO PEAK VOLTAGE PROBE KIT
SHIP. WT. 2 LBS. \$6.50
No. 338
Reads on DC scale of any 11 megohm VTVM 5 kc to 5 megacycle range.

NEW Heathkit BATTERY TESTER KIT

The new Heathkit Battery Tester measures all types of dry batteries between 1½ volts and 150 volts under actual load conditions. Readings are made directly on a three-color GOOD-WEAK-REPLACE scale that your customers can readily understand. Operation is extremely simple and merely requires that the leads be connected to the battery under test. Only one control to adjust in addition to a panel switch for A or B battery types.

The Heathkit Battery Tester features compact assembly. An accurate meter movement and wire wound control mount in the portable, rugged plastic case.

Use the BT-1 to check portable radio batteries, hearing aid batteries, lantern batteries and photo flash gun batteries.

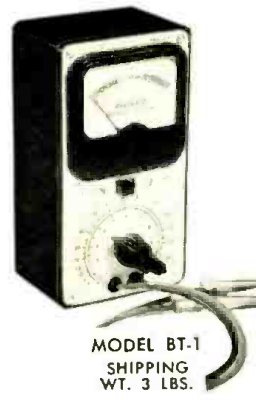

MODEL BT-1
SHIPPING
WT. 3 LBS.
\$750

Heathkit AC VACUUM TUBE VOLTMETER KIT

A new AC VTVM that makes possible those sensitive AC measurements required by laboratories, audio enthusiasts and experimenters. Ten full scale ranges of .01, .03, .1, .3, 1, 3, 10, 30, 100 and 300 volts RMS. 10 DB ranges from -52 to +52 DB. Frequency response within 1 DB from 20 cycles to 50 kc. Simpson 200 microampere meter with large plainly marked meter scales. Precision multiplier resistors. Two amplifier stages using miniature tubes. A unique bridge rectifier meter circuit and a clean layout of parts.

Order the AV-2 today and become acquainted with the interesting possibilities offered by this instrument.



MODEL AV-2
SHIPPING
WT. 5 LBS.
\$2950

EXPORT AGENT
ROCKE INTERNATIONAL CORP.
13 E. 40th ST.
NEW YORK CITY (16)
CABLE ARLAD-N.Y.

The **HEATH COMPANY**

... BENTON HARBOR 15, MICHIGAN

NEW *Heathkit* GRID DIP METER KIT

• CONVENIENT ONE HAND OPERATION.

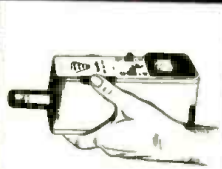
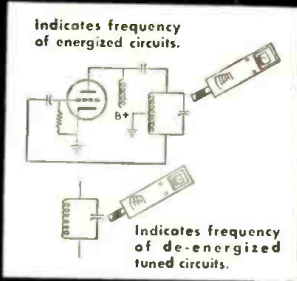

Complete unit easily held and operated with one hand.

MODEL GD-1

SHIPPING
WT. 4 LBS.

\$19⁵⁰



- New GRID DIP METER with assembled calibrated coils.
- Uses quality Simpson 500 microampere meter.
- One hand operation, extremely compact. Only 2½" wide by 3" high by 7" long.
- Variable meter sensitivity control.
- Uses newest type 6AF4 high frequency triode in a Colpitts oscillator circuit.
- Continuous coverage from 2 megacycles to over 250 megacycles in 6 ranges.
- Head phone monitoring jack.
- AC power transformer operated for maximum safety.

Here is the GRID DIP METER KIT you have been asking for. This new HEATHKIT instrument is compact, highly sensitive and easy to use. Housed in a handsome formed aluminum cabinet—rounded corners—durable oven baked finish on panel and cabinet. The entire instrument can be easily held and operated in one hand, tuning accomplished with the thumb wheel drive. This excellent design feature leaves the other hand entirely free for making circuit adjustments. The instrument with many applications—with oscillator energized, use it for finding the resonant frequency of tuned circuits, locating parasitics, determining characteristics of filter circuits, roughly tuning transmitter stages with power off, and neutralizing transmitters. Useful in TV and radio repair work for alignment of traps, filters, IF stages, peaking and compensation networks within the 2 to 250 megacycle range. With the oscillator not energized, the instrument acts as an absorption wave meter and indicates the frequency of radiating power sources. Locates spurious oscillations, as a relative indication of power in various transmitter stages, etc. Phone jack permits monitoring of AM transmitter for determination of radiated hum, audio quality, etc. (Head phones not included). Complete kit includes plug-in coils, tube, all necessary parts and detailed assembly and instruction manual.

Heathkit IMPEDANCE BRIDGE KIT



MODEL IB-1B
SHIPPING
WT. 15 LBS.

\$69⁵⁰

The HEATHKIT IMPEDANCE BRIDGE is especially useful in educational training programs, industrial laboratories and for experimental work. Use it for measuring AC and DC resistance value of resistors.

determination of condenser capacitance and dissipation factor, finding coil inductance and storage factor, electrical measurements work, etc. Quality components: GR 1000 cycle hummer, GR main control, Mallory ceramic wafer silver plated contact switches, ½% precision resistors, etc. The basic circuit is a self powered, 4 arm bridge. Choice of Wheatstone, Capacitance comparison, Maxwell or Hay bridge circuits. Resistance from 10 milliohm to 10 megohm. Capacitance 10 mmf to 100 mfd. Inductance 10 microhenry to 100 henries. Dissipation factor .002 to 1. Storage factor (Q) 1 to 1000. The IMPEDANCE BRIDGE has provisions for external generator use for measurement at other than the 1000 cycle level. Take the guess work out of electrical measurements. The HEATHKIT IMPEDANCE BRIDGE mounted in a beautiful polished birch cabinet with large easy reading panel calibrations will furnish years of accurate, trouble free measurement service.

Heathkit HANDITESTER KIT

The HEATHKIT Model M-1 HANDITESTER fulfills requirements for a portable volt ohm milliammeter. This kit features precision 1% resistors, 3 deck switch for trouble free mounting of parts, specially designed battery bracket, smooth acting ohms adjust control, beautiful molded bakelite case and a 400 microampere meter movement. 5 convenient AC and DC voltage ranges as follows: 10 - 30 - 300 - 1000 - 5000 volts. Ohms ranges 0 - 3000 and 0 - 300,000. DC milliamperage ranges 0 - 10 milliamperes and 0 - 100 milliamperes. The instrument is easily assembled from complete instructions and pictorial diagrams. Test leads are included. Carry the HEATHKIT M-1 HANDITESTER in your tool box at all times for those simple jobs and eliminate that extra trip for additional testing equipment.



MODEL M-1
SHIPPING
WT. 3 LBS.

\$13⁵⁰

EXPORT AGENT
ROCKE INTERNATIONAL CORP.
12 E. 40th ST.
NEW YORK CITY (16)
CABLE AR160-N.Y.

The HEATH COMPANY

... BENTON HARBOR 15, MICHIGAN

NEW
Heathkit

AUDIO GENERATOR KIT

• RANGE EXTENDED TO 1 MEGACYCLE

MODEL AG-8

SHIPPING
WT. 16 LBS.

\$29.50

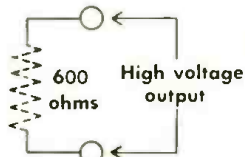

Low impedance output
High voltage output



Sine wave output
from 20 cycles to 1
megacycle.

- Improved design — new low price.
- Frequency coverage in five ranges from 20 cycles per second to 1 megacycle.
- Response flat 1 DB from 20 cycles to 400 kilocycles. Down 3 DB at 600 kilocycles. Down only 8 DB at 1 megacycle.
- Five calibrated output voltage ranges, continuously variable 1 mv, 10 mv, 100 mv, 1 v, 10 v.
- Low impedance output circuit. 600 ohms.
- Distortion less than .4 of 1% from 100 cycles per second through the audible range.
- New HEATHKIT universal type binding posts.
- Durable infra-red baked enamel panel.
- Transformer operated for safe operation.
- Sturdy, ventilated steel cabinet.

A new Audio Generator with features heretofore found in only the most expensive generators. Such features as complete coverage from 20 cycles to 1 Mc — response flat ± 1 db from 20 cycles to 400 Kc, down 3 db at 600 Kc and down only 8 db at 1 Mc.

And it has calibrated output . . . Calibrated continuously variable and step attenuator output controls allow you to easily set calibrated output voltage. Moreover, distortion is less than .4 of 1% from 100 cps through the audible range.

Oscillator section consists of a two stage resistance coupled amplifier (6SJ7 and 6AK6) utilizing both positive and negative feedback for oscillator operation and reduction of distortion. Oscillator section drives a cathode follower output power amplifier (6AK6) which isolates the oscillator from variations in load and presents a low impedance output (600 Ohms). Power supply is transformer operated and utilizes 6X5 rectifier with 2 sections of RC filtering.

An unbeatable dollar value — for here is an audio generator with wide frequency coverage, excellent frequency response, stepped and continuously variable calibrated output, high signal level, low impedance output, and low inherent distortion.

Heathkit AUDIO FREQUENCY METER KIT

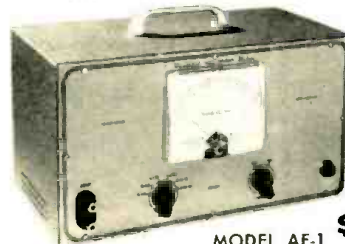

MODEL AF-1

SHIPPING
WT. 15 LBS.

\$34.50

The HEATHKIT AUDIO FREQUENCY METER provides a simple and easy way to check unknown audio frequencies from 10 cycles to 100 kc between 3 and 300 volts RMS. The instrument features 7 ranges for accuracy and wide coverage. The meter itself has a quality 200 microampere Simpson movement and large clearly marked scales. The AUDIO FREQUENCY METER is transformer operated and features a voltage regulator tube to maintain constant plate voltage on the second stage. Kit supplied complete with all necessary construction material and a detailed construction manual.

NEW *Heathkit* AUDIO OSCILLATOR KIT



MODEL AO-1
SHIPPING
WT. 14 LBS.

\$24.50

A new Audio Oscillator with both sine and square wave coverage from 20 to 20,000 cycles . . . An instrument designed to completely fulfill the needs of the audio engineer and enthusiast — Has numerous advantages such as high level output (up to 10V obtainable across the entire range), distortion less than .6%, and low impedance output.

Special design features include the use of a thermistor in the second amplifier stage for keeping the output essentially flat across the entire range.

A cathode coupled clipper circuit produces good, clean, square waves with rise time of only 2 microseconds. Oscillator section uses 1% precision resistors in range multiplier circuit for greatest accuracy.

You'll like the operation of this fine new kit.

Heathkit SQUARE WAVE GENERATOR KIT



MODEL SQ-1
SHIPPING
WT. 14 LBS.

\$29.50

The HEATHKIT SQUARE WAVE GENERATOR is an excellent square wave frequency source with wide range coverage from 10 cycles to 100 kc continuously variable. This feature makes it useful for TV and wide band amplifier work as well as audio experimentation. The output voltage is continuously variable between 0 and 20 volts. The circuitry consists of a multivibrator stage, a clipping and squaring stage and a cathode follower low impedance output stage. The power supply is transformer operated and utilizes a full wave rectifier circuit with two sections of filtering. Another excellent HEATHKIT value at this remarkable low price. Kit includes all necessary construction material as well as complete instruction manual for assembly and operation.

EXPORT AGENTS
ROCKE INTERNATIONAL CORP.
13 E. 40th ST.
NEW YORK CITY 100
CALL 867-8400

The **HEATH COMPANY**

... BENTON HARBOR 15, MICHIGAN

NEW *Heathkit* SIGNAL TRACER KIT

• NEW NOISE LOCATOR AND WATTMETER CIRCUITS.

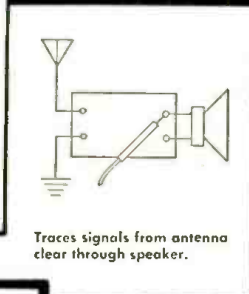
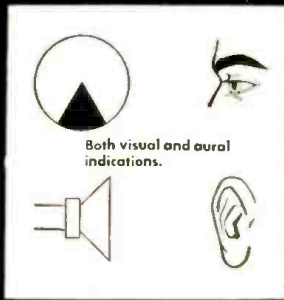

MODEL T-3

SHIPPING
WT. 8 LBS.

\$22.50



- Permits visual signal observation as well as aural operation.
- Two separate input channels.
- Tremendous RF channel sensitivity. Adequate for actual signal detection at receiver input.
- Separate high gain RF and low gain audio channels.
- A unique and useful noise locator circuit.
- Built-in calibrated wattmeter.
- Two separate shielded probes for RF and audio application.
- Additional test leads supplied.
- Substitution test speaker and output transformer eliminates necessity for speaker removal in service work.
- Utility amplifier. Check record changers, tuners, microphones, instrument pickups, etc.
- VTVM and Scope panel terminals.
- 5 tube transformer operated circuit.

The new HEATHKIT VISUAL AURAL SIGNAL TRACER represents one of the most convenient and useful instruments the service man can use in AM, FM and TV service work. The electron ray beam indicator constantly monitors both input channels for visual observation of the signal. Now, see and hear the signal level for easier estimation of signal strength and gain per stage in a receiver circuit. Separate high gain channel and special shielded demodulator probe for RF circuit work. Low gain channel for audio circuit investigation and for use as a noise locator. In this feature, approximately 200 volts DC is applied to a suspected circuit component and the action of the voltage in the component can be seen and heard to determine satisfactory operation. This feature alone will prove tremendously helpful in locating the source of objectionable noises in coils, transformers, resistors, cold solder joints, controls, etc. A convenient wattmeter permits rapid preliminary check for voltage distribution circuit breakdown as well as transformer failures. Use the T-3 as a universal test speaker and substitution transformer and save service time by eliminating the necessity for speaker removal on every service call. Additional service uses are: as a utility amplifier for checking the output of record changers, tuners, microphones, instrument pickups, etc. Separate panel terminals permit utilization of other shop equipment such as your Oscilloscope or VTVM. Entire kit supplied complete with 5 tubes, all necessary construction material along with a detailed step by step instruction manual for the assembly and operation of the instrument.

NEW *Heathkit* CONDENSER CHECKER KIT



MODEL C-3
SHIPPING
WT. 7 LBS.

\$19.50

Announcing the new improved MODEL C-3 HEATHKIT CONDENSER housed in a new smartly styled professional appearing cabinet featuring rounded corners and snug fitting drawn panel. Adequate provisions for ventilation insures longer instrument life through cooler operation. Use the C-3 to accurately measure those unknown condenser and resistor values. All readings of condensers and resistors are read directly on the calibrated scales. Range of condenser measurements is from .00001 mfd to 1000 mfd. Calibrated resistance measurements can be made from 100 ohms to 5 megohms. A leakage test with a choice of 5 DC polarizing voltages will quickly indicate condenser operating quality under actual voltage load conditions. The spring return leakage test switch automatically discharges the condenser under test and eliminates shock hazard. An electron ray beam indicator tube is used in a new leakage test circuit for added sensitivity. The instrument is transformer operated for safety and will prove an extremely welcome addition to your shop equipment. The kit is furnished complete with all necessary parts, test leads and includes a step by step detailed construction manual for assembly and operation.

insures longer instrument life through cooler operation. Use the C-3 to accurately measure those unknown condenser and resistor values. All readings of condensers and resistors are read directly on the calibrated scales. Range of condenser measurements is from .00001 mfd to 1000 mfd. Calibrated resistance measurements can be made from 100 ohms to 5 megohms. A leakage test with a choice of 5 DC polarizing voltages will quickly indicate condenser operating quality under actual voltage load conditions. The spring return leakage test switch automatically discharges the condenser under test and eliminates shock hazard. An electron ray beam indicator tube is used in a new leakage test circuit for added sensitivity. The instrument is transformer operated for safety and will prove an extremely welcome addition to your shop equipment. The kit is furnished complete with all necessary parts, test leads and includes a step by step detailed construction manual for assembly and operation.

Heathkit TV ALIGNMENT GENERATOR KIT

MODEL TS-2
SHIPPING
WT. 20 LBS.

\$39.50



Here is an excellent TV ALIGNMENT GENERATOR designed to do TV service work quickly, easily and properly. The Model TS-2 when used in conjunction with an Oscilloscope provides a means of correctly aligning TV receivers. The instrument furnishes a frequency modulated signal covering in 2 bands the range of 10 to 90 megacycles and 150 to 230 megacycles. An absorption type frequency marker covers from 20 to 75 megacycles in 2 ranges; therefore you have a simple, convenient means of checking IF's independent of oscillator calibration. Sweep width is variable from 0 to 12 megacycles. Other excellent features are horizontal sweep voltage controlled with a phasing control — both step and continuously variable attenuation for setting the output signal to the desired level — a convenient stand by switch — and blanking for establishing a single trace with a base reference level. Make your work easier, save time and repair with confidence. Order your HEATHKIT TV ALIGNMENT GENERATOR now.

Here is an excellent TV ALIGNMENT GENERATOR designed to do TV service work quickly, easily and properly. The Model TS-2 when used in conjunction with an Oscilloscope provides a means of correctly aligning TV receivers. The instrument furnishes a frequency modulated signal covering in 2 bands the range of 10 to 90 megacycles and 150 to 230 megacycles. An absorption type frequency marker covers from 20 to 75 megacycles in 2 ranges; therefore you have a simple, convenient means of checking IF's independent of oscillator calibration. Sweep width is variable from 0 to 12 megacycles. Other excellent features are horizontal sweep voltage controlled with a phasing control — both step and continuously variable attenuation for setting the output signal to the desired level — a convenient stand by switch — and blanking for establishing a single trace with a base reference level. Make your work easier, save time and repair with confidence. Order your HEATHKIT TV ALIGNMENT GENERATOR now.

EXPORT AGENT
ROCKE INTERNATIONAL CORP.
13 E. 40th ST.
NEW YORK CITY (16)
CABLE: ARLAB-N.Y.

The **HEATH COMPANY**

... BENTON HARBOR 15, MICHIGAN

Heathkit TUBE CHECKER KIT

MODEL TC-1

SHIPPING
WT. 12 LBS.

\$29⁵⁰

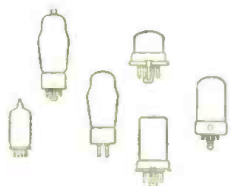
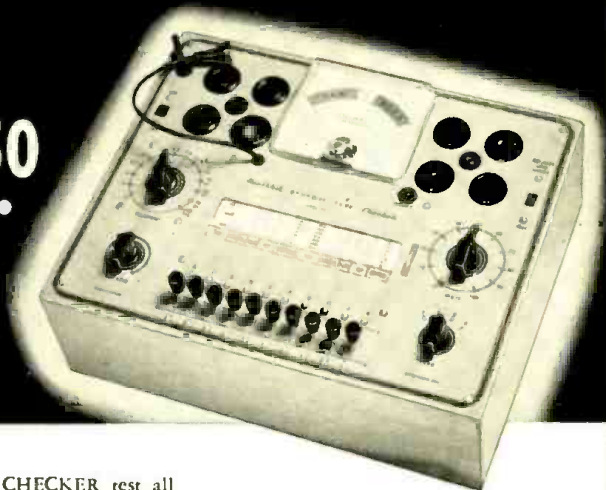

Checks 7, 8, 9 prong tubes, octals, localis, 7 and 9 prong miniatures, 5 prong Hytrons, pilot lights.



Checks for opens, shorts, emission, filament and filament tap continuity.

- Beautiful counter type birch cabinet.
- 4½" Simpson 3 color meter.
- Simplified setup procedure.
- Built-in gear driven roll chart.
- Checks emission, shorted elements, open elements and continuity.
- Complete protection against obsolescence.
- Sockets for every modern tube.
- Blank for new types.
- Individual element switches.
- Contact type pilot light test socket.
- Line adjust control.

PORTABLE TUBE CHECKER KIT MODEL TC-1P

Same as TC-1 except supplied with polished birch cabinet (with removable lid) instead of counter type cabinet. Shipping weight 14 lbs. **\$34.50**

No. 365 Polished Birch Tube Checker Cabinet only. Shipping Weight 7 lbs. **\$7.50**

With the HEATHKIT TC-1 TUBE CHECKER test all types of tubes commonly encountered in AM-FM and TV receiver circuits. Test setup procedure is simplified, rapid and flexible. Tube quality is read directly on a beautiful 4½" Simpson three color BAD · ? · GOOD scale that your customers can readily understand. Panel sockets accommodate 4, 5, 6 and 7 prong tubes, octals, localis, 7 and 9 prong miniatures, 5 prong Hytrons, a blank socket for new tubes and a contact type socket for quick checking of pilot lights. Built-in gear driven roll chart for instant reference. Neon short indicator, individual three position lever switch for each tube element, spring return test switch, line set control to compensate for supply voltage variations. At this low price, no service man need be without the advantages offered by the HEATHKIT TUBE CHECKER.

Heathkit TV PICTURE TUBE TEST ADAPTER

Use your HEATHKIT TUBE CHECKER with this new TV TEST ADAPTER to determine picture tube quality. Check for emission and shorts, independent of TV power supply. Consists of standard 12 pin TV tube socket, 4 feet of cable, octal socket connector and data sheet. Quickly prove TV picture tube condition to yourself and your customer.



No. 355
Ship. Wt. **\$4⁵⁰**
1 lb.

Heathkit RESISTANCE SUBSTITUTION BOX KIT



MODEL RS-1
SHIPPING
WT. 3 LBS.

\$5⁵⁰

NEW HEATHKIT RESISTANCE SUBSTITUTION BOX KIT provides switch selection of any single one of 36 RTMA 1 watt 10% standard value resistors, ranging from 15 ohms to 10 megohms. This coverage available in 2 ranges in decades of 15, 22, 33, 47, 68 and 100. Housed in rugged plastic cabinet featuring new HEATHKIT universal type binding posts. The entire kit priced less than the retail value of the resistors alone.

Heathkit BATTERY ELIMINATOR KIT

A clean 6 volt d-c supply source is definitely required for successful automobile radio servicing. Has a continuously variable d-c output from 0 to 8 volts. It can be safely operated at a steady 10 ampere level and will deliver up to 15 amperes for intermittent periods. The voltage output terminals are completely isolated from the chassis to accommodate additional service applications such as supplying bias voltages or d-c substitution voltages for battery operated tube filament circuits.

The output of the Battery Eliminator is constantly monitored by a d-c voltmeter and a d-c ammeter. The circuit features an automatic overload relay of self resetting type. For additional protection, a panel mounting fuse is provided. Build this kit in a few hours and pocket a substantial savings.



MODEL BE-3
SHIPPING
WT. 20 LBS.

\$24⁵⁰

Heathkit VIBRATOR TESTER KIT

Repair time is valuable, and the Heathkit Vibrator Tester will save you hours of work. Instantly tells the condition of the vibrator under test — and the check is thorough and complete. Checks vibrator for proper starting, and the easy-to-read meter indicates the quality of output on large BAD-GOOD scales. Tests both interrupter and selfrectifier types of vibrators. Five different sockets for checking hundreds of vibrators.

Operates from any battery eliminator capable of delivering continuously variable voltage from 4-6V at 4 amps. The Heathkit BE-3 Battery Eliminator is ideal for operating this kit.

Faulty vibrators can be spotted within seconds and you're free to go on to other service jobs.

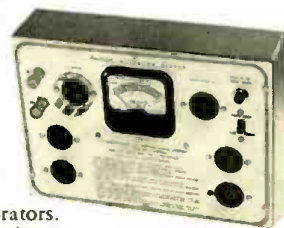

MODEL VT-1
SHIPPING
WT. 7 LBS.

\$14⁵⁰

EXPORT AGENT
ROCKE INTERNATIONAL CORP.
13 E. 40th ST.
NEW YORK CITY (16)
CABLE APRAE N Y

The **HEATH COMPANY**

... BENTON HARBOR 15, MICHIGAN

Heathkit SIGNAL GENERATOR KIT

MODEL SG-7

SHIPPING
WT. 7 LBS.

\$19.50

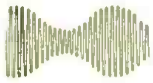

Modulated or unmodulated RF output.



400 cycle sine wave output.

- Step attenuated RF output.
- 6 to 1 vernier dial ratio.
- Turret mounted coil sub-assembly.
- Pre-calibrated and adjusted coils.
- Hartley RF oscillator circuit.
- Colpitts oscillator 400 cycle sine wave output.
- Modulated or unmodulated RF output.
- Frequency coverage on fundamentals 160 kc to 5 megacycles in five ranges. 5 megacycles to 150 megacycles on calibrated harmonics.
- RF output in excess of 100,000 microvolts.
- Audio output 1½ to 2 volts.
- AC transformer operated.
- Professionally styled cabinet.
- Infra red baked enamel panel.

The new HEATHKIT Model SG-7 SIGNAL GENERATOR easily fulfills requirements for a controllable, modulated or unmodulated source of variable frequency. A convenient 400 cycle sine wave output is available for audio work. All RF oscillator coils are precision wound and adjusted to calibration before shipment thereby assuring maximum accuracy. The coils, band switch and tuning condenser all mount as a turret assembly so as to offer the advantage of short wiring leads and easy mounting of parts. The RF output circuit is of the low impedance type obtained by the use of cathode coupling to the output jacks. The level of RF output is varied by means of the RF step and RF output control. Use the HEATHKIT SG-7 as an RF signal source modulated or unmodulated for radio repair, laboratory work, experimental testing, 400 cycle sine wave audio testing, checking RF stages, alignment of both AM and FM IF stages, marker generator for TV alignment, etc. The kit is transformer operated and utilizes miniature tubes for ease in handling high frequency. Panel jacks and a convenient switching system permit either external or internal modulation. The entire kit is supplied complete with tubes and all necessary material as well as a detailed step by step instruction manual for the assembly and operation of the instrument.

Heathkit INTERMODULATION ANALYZER KIT



MODEL IM-1
SHIPPING WT.
18 LBS.

\$39.50

The HEATHKIT MODEL IM-1 is an extremely versatile instrument specifically designed for measuring the degree of interaction between two

signals caused by a specific piece of apparatus, or a chain of equipment. It is primarily intended for tests of audio equipment but may be used in other applications such as making tests of microphones, records, recording equipment, phonograph pickups and loud speakers. Use it for checking tape or disc recordings, as a sensitive AC voltmeter, as a high pass noise meter for adjusting tape bias, cutting needle pitch or other applications. High and low test frequency source, intermodulation section, power supply and AC voltmeter all in one complete unit. Percent intermodulation is directly read on three calibrated ranges, 30%, 10% and 3% full scale. Both 4 to 1 and 1 to 1 ratios of low to high frequencies easily set up. At this low kit price YOU can enjoy the benefits of Intermodulation analysis for accurate audio interpretations.

Heathkit LABORATORY REGULATED POWER SUPPLY KIT



MODEL PS-2
SHIPPING
WT. 20 LBS.

\$29.50

New HEATHKIT LABORATORY POWER SUPPLY provides continuously variable regulated DC voltage output

from 160 volts to 400 volts depending on load. Panel terminals supply separate 6.3 V. AC supply at 4 amperes for filament circuits. A 3½" plastic cased panel mounted meter provides accurate metered output for either voltage or current measurements. Exceptionally low ripple content of .012% admirably qualifies the HEATHKIT LABORATORY POWER SUPPLY for high gain audio applications. Ideal for laboratory work requiring a reference voltage for meter calibration or for plotting tube characteristics. In service work, it can be used as a separate variable voltage supply to determine the desirable operating voltage in a specific circuit. Use it as a DC substitution voltage in trouble shooting TV circuits exhibiting symptoms of extraneous undesirable components in plate supply circuits. Entire kit, including all 5 tubes now available at this low price.

EXPORT AGENT
ROCKE INTERNATIONAL CORP.
13 E. 40th ST.
NEW YORK CITY (16)
CABLE ARLAN-NT

The HEATH COMPANY

... BENTON HARBOR 15, MICHIGAN

Heathkit WILLIAMSON TYPE AMPLIFIER KIT

The new HEATHKIT WILLIAMSON TYPE AMPLIFIER incorporates the latest improvements described in Audio Engineering's "Gilding the Lily." 5881 output tubes and a new Peerless output transformer with additional primary taps afford peak power output of well over 20 watts. Frequency response ± 1 db from 10 cycles to 100 kc. allows reproduction of highs and lows with equal crispness and clarity. Harmonic and intermodulation distortion have been reduced to less than $\frac{1}{2}$ of 1% at 5 watts. This eliminates the harsh unpleasant qualities which contribute to listening fatigue. Make this amplifier the heart of your radio system to achieve the fine reproduction that is the goal of all music lovers.

The HEATHKIT PREAMPLIFIER (available separately or in combination with the amplifier kit) features inputs for magnetic or low level cartridges, crystal pickups and tuners, turnover control for LP or 78 type records, individual bass and treble tone controls each providing up to 15 DB of boost or attenuation. Special notched shafts on preamplifier controls and switches adaptable to custom installation. The preamplifier can be mounted in any position and a liberal length of connecting cable is supplied. No radio experience is required to construct this amplifier. All punching, forming, or drilling has already been done. The complete kit includes all necessary parts as well as a detailed step by step construction manual with pictorial diagrams to greatly simplify the construction.



ACROSOUND TRANSFORMER OPTION. If desired, the output transformer with the kit will be the Acrosound output transformer, type TO-300. The use of this transformer permits ultra-linear operation as described in Audio Engineering's "Ultra-Linear Operation of the Williamson Amplifier."

Heathkit FM TUNER KIT



MODEL FM-2
SHIPPING
WT. 9 LBS.

\$22⁵⁰

The HEATHKIT MODEL FM-2 TUNER specifically designed for simplified kit construction features a preassembled and adjusted tuning unit. Three double tuned IF transformers and a discriminator transformer are used in an 8 tube circuit. Smooth tuning is obtained through a 9 to 1 ratio vernier drive using a calibrated six inch slide rule type dial. The usual frequency coverage of 88 to 108 megacycles is provided.

Experience the thrill of building your own FM tuner. Operate it through your amplifier or radio and enjoy all the advantages of true FM reception. Transformer operated power supply to simplify connections to all types of audio systems. The kit is supplied complete with all 8 tubes and a necessary material required for construction. A complete instruction manual simplifies assembly and operation.

PRICES OF VARIOUS COMBINATIONS

W-2 Amplifier Kit (Incl. Main Amplifier with Peerless Output Transformer, Power Supply and WA-P1 Preamplifier Kit) Shipping Weight 39 lbs.	\$69⁵⁰
W-2M Amplifier Kit (Incl. Main Amplifier with Peerless Output Transformer and Power Supply) Shipping Weight 29 lbs. Shipped express only	\$49⁷⁵
W-3 Amplifier Kit (Incl. Main Amplifier with Acrosound Output Transformer, Power Supply and WA-P1 Preamplifier Kit) Shipping Weight 39 lbs. Shipped express only	\$69⁵⁰
W-3M Amplifier Kit (Incl. Main Amplifier with Acrosound Output Transformer and Power Supply) Shipping Weight 29 lbs. Shipped express only	\$49⁷⁵
WA-P1 Preamplifier Kit only. Shipping Weight 7 lbs. Shipped express or parcel post.	\$19⁷⁵

Heathkit ECONOMY 6 WATT AMPLIFIER KIT



MODEL A-7
SHIPPING
WT. 10 LBS.

\$14⁵⁰

The HEATHKIT Model A-7 amplifier features beam power, push pull output with frequency response flat $\pm 1\frac{1}{2}$ DB from 20 to 20,000 cycles. Separate volume, bass and treble controls. Two input circuits, output impedances of 4, 8, and 15 ohms. Peak power output rated at full 6 watts. High quality components, simplified layout, attractive gray finished chassis, break off type adjustable length control shafts and attractive lettered control panel.

THE MODEL A7A amplifier incorporates a preamplifier stage with special compensated network to provide the necessary voltage gain for operation with variable reluctance or low output level phono cartridges. Excellent gain for microphone operation in a moderate powered sound system.....**\$16.50**

Heathkit HIGH FIDELITY 20 WATT AMPLIFIER KIT

The HEATHKIT MODEL A-8 amplifier kit was designed to deliver high fidelity performance with adequate power output at moderate cost. The frequency response is within ± 1 DB from 20 to 20,000 cycles. Distortion at 3 DB below maximum power output at 1000 cycles is only .8%. The amplifier features a Chicago power transformer in a drawn steel case and a Peerless output transformer with output impedances of 4, 8, and 16 ohms available. Separate bass and treble tone controls permit wide range of tonal adjustment to meet the requirements of the most discerning listener. The amplifier uses a 6SJ7 voltage amplifier, a 6SN7 amplifier and phase splitter and two 6L6's in push pull output and a 5U4G rectifier. Two input jacks for either crystal or tuner operation. The kit includes all necessary material as well as a detailed step by step construction manual.

MODEL AB-A features an added 6SJ7 stage (preamplifier) for operating from a variable reluctance cartridge or other low output level phono pickups. Can also be used with a microphone. A 3 position panel switch affords the desired input service.**\$35.50**



MODEL A-8
SHIPPING WT. 19 LBS.

\$33⁵⁰

SOLE AGENTS
ROCKE INTERNATIONAL CORP.
12 E. 40th ST.
NEW YORK CITY (16)
CABLE: AR148-N.Y.

The **HEATH COMPANY**

... BENTON HARBOR 15, MICHIGAN

Heathkit SUPERHETERODYNE RECEIVER KITS

- High gain dual iron core tuned type IF transformers
- AC transformer operation for safety
- Continuously variable tone control
- Sturdy punched and plated steel chassis
- Ideal for custom installation
- Full AVC action
- Inverse feedback for improved frequency response
- Kit supplied with all necessary construction material except speaker and cabinet. (Available separately if desired).

6 tube all wave circuit.
3 ranges, continuous coverage 550 kc to over 20 megacycles, shipping wt. 11 lbs.

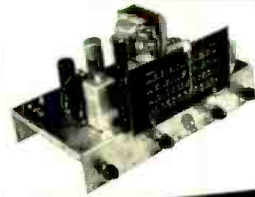

Model AR-1
\$23.50

5 tube broadcast band
550 to 1600 kc coverage,
shipping wt. 11 lbs.

Model BR-1
\$19.50



Two excellent radio receiver kits featuring clean design and open layout for simplified construction. Satisfy that urge to build your own radio receiver and select the model which meets your requirements. Both receivers feature continuously variable tone control, a radio phono switch and phono input and an AC receptacle for the phono motor. A six inch calibrated slide rule type dial with a 9 to 1 ratio vernier dial drive insures easy tuning.

SHIPPING INFORMATION

ON PARCEL POST ORDERS include postage for weight shown and insurance. (We insure all shipments.) Don't worry about sending more than the correct amount — if you send us too much, every extra cent will be promptly returned.

ON EXPRESS ORDERS do not include transportation charges. They will be collected by Express Agency on delivery.

ORDERS FROM CANADA must include full remittance for merchandise.

Orders processed on the same day received. Customers notified of unavoidable delay.

U. S. postal or express money orders, bank drafts or checks are acceptable. Do not send loose coins or stamps.

ALL PRICES SUBJECT TO CHANGE WITHOUT NOTICE

EXPORT AGENT
ROCKE INTERNATIONAL CORP.
13 E. 40th ST.
NEW YORK CITY 16
CABLE ADLAD N.Y.

The HEATH COMPANY

... BENTON HARBOR 15, MICHIGAN

ORDER BLANK



From _____

SHIP VIA

- Parcel Post
- Express
- Freight
- Best Way

(PLEASE PRINT)

QUANTITY	ITEM	PRICE	QUANTITY	ITEM	PRICE
	Heathkit Oscilloscope Kit—Model O-8 (29 lbs.)	\$43.50		Heathkit Square Wave Gen. Kit—Model SQ-1 (14 lbs.)	\$29.50
	Heathkit Intensifier Kit (O-8 only) No. 339 (1 lb.)	7.50		Heathkit AC VTVM Kit—Model AV-2 (5 lbs.)	29.50
	Heathkit Voltage Calibrator Kit—Model VC-1 (5 lbs.)	9.50		Heathkit Intermodulation Analyzer Kit—Model IM-1 (18 lbs.)	39.50
	Heathkit Electronic Switch Kit—Model S-2 (11 lbs.)	19.50		Heathkit Regulated Power Supply Kit—Model PS-2 (20 lbs.)	29.50
	Heathkit Scope Demodulator Probe Kit No. 337 (1 lb.)	4.50		Heathkit Handtester Kit—Model M-1 (3 lbs.)	13.50
	Heathkit T.V. Alignment Generator Kit—Model TS-2 (20 lbs.)	39.50		Heathkit Decade Resistance Kit—Model DR-1 (4 lbs.)	19.50
	Heathkit Q Meter Kit—Model QM-1 (12 lbs.)	39.50		Heathkit Decade Condenser Kit—Model DC-1 (4 lbs.)	16.50
	Heathkit Grid Dip Meter Kit—Model GD-1 (4 lbs.)	19.50		Heathkit Impedance Bridge Kit—Model IB-1B (15 lbs.)	69.50
	Heathkit VTVM Kit—Model V-6 (7 lbs.)	24.50		Heathkit Battery Tester Kit—Model BT-1 (3 lbs.)	7.50
	Heathkit RF Probe Kit No. 309 (1 lb.)	5.50		Heathkit Resistance Substitution Box Kit—Model RS-1 (3 lbs.)	5.50
	Heathkit HV Probe Kit No. 336 (2 lbs.)	5.50		Heathkit F.M. Tuner Kit—Model FM-2 (9 lbs.)	22.50
	Heathkit Peak-to-Peak Volt. Probe Kit No. 338 (2 lbs.)	6.50		Heathkit Broadcast Receiver Kit—Model BR-1 (11 lbs.)	19.50
	Heathkit Visual-Aural Signal Tracer Kit—Model T-3 (8 lbs.)	22.50		Heathkit Three Band Receiver Kit—Model AR-1 (11 lbs.)	23.50
	Heathkit Condenser Checker Kit—Model C-3 (7 lbs.)	19.50		Heathkit Amplifier Kit—Model A-7 (10 lbs.)	14.50
	Heathkit RF Signal Generator Kit—Model SG-7 (7 lbs.)	19.50		Heathkit Amplifier Kit—Model A-7A (10 lbs.)	16.50
	Heathkit Tube Checker Kit—Model TC-1 (12 lbs.)	29.50		Heathkit Amplifier Kit—Model A-8 (19 lbs.)	33.50
	Heathkit T.V. Tube Adapter No. 355 (1 lb.)	4.50		Heathkit Amplifier Kit—Model A-8A (19 lbs.)	35.50
	Heathkit Battery Eliminator Kit—Model BE-3 (20 lbs.)	24.50		Williamson Type Amplifier Kit (Type.)	
	Heathkit Vibrator Tester Kit—Model VT-1 (7 lbs.)	14.50		Shipped express only	
	Heathkit Audio Generator Kit—Model AG-8 (16 lbs.)	29.50		WA-P1 Preamplifier Kit (7 lbs.) (Shipped exp. or p.p.)	19.75
	Heathkit Audio Oscillator Kit—Model AO-1 (14 lbs.)	24.50			
	Heathkit Audio Frequency Meter Kit—Model AF-1 (15 lbs.)	34.50			

*Please ship C.O.D. Postage enclosed for _____ lbs.

Enclosed find Check Money Order for _____

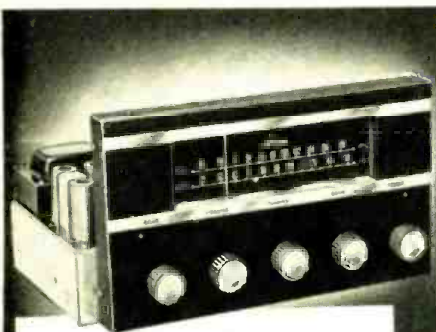

We rest our case
on evidence
you can hear



Words can't prove
the performance
of this superb High
Fidelity Tuner.
Neither can witness-
es. When it's time for

a decision, your judgement of
the CRAFTSMEN 10 is based on one
thing: evidence you hear with your own
ears. Listen—and the conclusive evi-
dence of incomparable sensitivity and
flexibility will turn your trial into a
lifetime of distinctly better listening.

the
craftsmen 10
high fidelity
FM-AM tuner

- Two cathode followers furnish both audio output and detector output for remote installations
- Built-in pre-amplifier, compensated for variable reluctance pick-ups.
- Automatic Frequency Control entirely eliminates drift, simplifies tuning.
- 5 microvolts sensitivity on both FM and AM.
- 10 kc filter on AM eliminates inter-station squeal.
- Bass and treble tone controls for boost, cut, or 20-20,000 cycle flat response.

JUDGE
THE C-500 TOO!
Williamson all-
triode circuit—
99.99% distur-
bance-free!



high fidelity by craftsmen
means distinctly better listening

For information, write to:
The radio CRAFTSMEN, Inc.
Dept. R-1, 4401 N. Ravenswood Ave.,
Chicago 40, Ill.

1953 TV Receivers (Continued from page 47)

enough for the vertical multivibrator and the horizontal phase-detector type a.f.c.

The third unique design is illustrated in Fig. 3A. This is the high voltage portion of the new G-E Model S21T1-B and, at first glance, appears to be a HV tripler. If we analyze the circuit closely we find that V_2 , a second 1X2A rectifier, is not really an active circuit element. The equivalent circuit in Fig. 3B shows that V_2 is only a resistance such as is commonly found in HV doubler circuits. Usually this resistance ranges between 2 and 6 megohms, and consists either of several carbon resistors in series or else of a special carbon film HV resistor. We know that a diode has a certain definite resistance R_p when current flows through it, and there is no reason why it could not be used in place of the regular fixed resistor. As a matter of fact, the diode resistance varies with the voltage across it. That is really the reason for its application here. Use of a HV diode greatly improves the regulation of the HV supply as more or less current is drawn. Assume for a moment that suddenly the picture on the screen gets brighter, resulting in increased current drain from the HV supply. This means that the voltage tends to drop both at V_1 and V_2 . Naturally this also means a voltage drop across V_2 . But when the voltage drops across this diode, its resistance increases substantially and the current through it is reduced. By reducing the current flowing through the bleeder resistance V_2 in Fig. 3B, the voltage available at V_3 is raised, counteracting the effect of the brighter picture on the screen. In actual practice the use of this diode really results in a substantial improvement of regulation and a more uniform focus and brightness on the screen. Keeping the anode voltage more constant also prevents blooming and the halo-effect often observed on some large screen picture tubes.

Some of the tubes listed here have made their appearance during the past year, but have only now found widespread acceptance and use. Detailed literature and performance data for each tube can be obtained from the manufacturers. Our purpose here is to give the reader an idea of each tube's use in the circuit and some indications as to the extent of its use. This will permit the service technician to recognize it in the set and also to get some idea as to how frequently he might encounter it in repairing new receivers.

6AH4GT: Octal, single triode, for vertical output amplifier. Used by *Sylvania, Philco, Zenith*.

6AQ7GT: Octal, duo-diode triode, horizontal a.f.c. circuit. Used by *Zenith*.

6AX4GT: Octal, diode, used as

damper in autotransformer flyback circuits because of high cathode to filament breakdown voltage. Found in *Admiral, CBS-Columbia, Motorola, Packard-Bell, Philco, Zenith*, and others.

6BF5: 7-pin miniature pentode, used as video amplifier by *Sylvania*.

6BX7GT: Octal, dual triode used as vertical amplifier by *G-E*.

6BZ7: 9-pin dual triode, for r.f. cathode similar to 6BK7. Used by *Admiral, DuMont, Motorola*.

6U8: 9-pin triode-pentode combination. Often used as r.f. mixer and oscillator or else as video-audio i.f. amplifier. *Motorola* and *Zenith* are major users of this tube.

6X8: 9-pin triode pentode combination, similar to 6U8. Used as r.f. mixer and oscillator by *Westinghouse*.

6V3: 9-pin miniature diode with top cap for plate connection. This tube is used as damper for autotransformer flyback circuits because of its high cathode-to-filament breakdown voltage. *Arvin, G-E, Philco, Sylvania*, and *Zenith* use it.

12AX4: Octal diode, same as the 6AX4 except for 12 volt filament. Used as damper by *Hallcrafters* and *Motorola*.

12BY7: 9-pin, pentode, used as video amplifier with G_m similar to 6AG7. *DuMont, Sylvania, Westinghouse*, and others use it.

12AZ7: 9-pin dual triode, used as r.f. mixer and oscillator by *Philco*. Similar electrically to 12AT7.

Conclusion

Although the new 1953 television receivers cannot boast of any radically new electrical development, many improvements in performance, economy and reliability of both circuits and components have been incorporated. New flyback transformers, simpler a.f.c. circuits and the new 40 mc. i.f. band are all further steps in reducing service troubles, eliminating instability, interference, and improving efficiency. While none of these innovations presents a new concept to the technician, it is still important to become familiar with the new circuits and components in order to service them correctly. Knowing new tube types helps in servicing, especially when regular tube manuals do not yet show these latest numbers.

AUDIO TRADE-INS

OF interest to the audiophile is the establishment of a new firm, The Audio Exchange Inc., 159-19 Hillside Ave., Jamaica 32, N. Y., which has been set up specifically to provide an exchange service for all types of audio gear.

The enthusiast can now sell his old equipment at the same time he purchases the new components or system he desires.

The company has developed a market for the used-guaranteed equipment which is accepted in trade-in. The service will be operated on a nationwide basis.



"WHY SHOULD I INSIST
ON **CBS-HYTRON**?"

"**YOU PROFIT MORE!**
HERE ARE
5 BIG REASONS WHY"



1. CBS-HYTRON IS FAMOUS . . . EASY TO SELL. The magic letters "CBS" are plugged for you on radio and TV station breaks . . . 102 BILLION times a year! CBS is known and respected by *all* your customers. CBS-Hytron is the profitable brand with endless sales assistance.



2. CBS-HYTRON SPECIALIZES IN RECEIVING TUBES. Since 1921, CBS-Hytron has concentrated on receiving types. Practice makes perfect. Put those years of know-how to work for you. Let time-proved CBS-Hytron dependability cut call-backs . . . make more money for you.



3. CBS-HYTRON LEADS IN TV TUBES. You know them. CBS-Hytron TV originals: 1AX2, 1X2A, 6BQ6GT, 12A4, 12B4, 12BH7, 12BY7, 12BZ7, 25BQ6GT, and the original rectangular 16RP4. Even CBS-Hytron standard TV tubes are designed-for-TV . . . tested-for-TV . . . to give you peak performance and profit.



4. CBS-HYTRON IS ULTRAMODERN. CBS-Hytron is the tube of the future. Made in the world's most modern plants. On manufacturing equipment years ahead of the rest of the industry. CBS-Hytron advanced design and precision construction keep you always ahead. Give you tomorrow's trouble-free performance today.

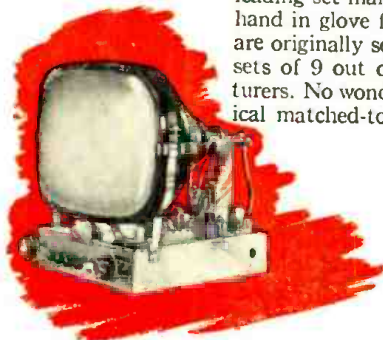

5. CBS-HYTRON IS MATCHED-TO-THE-SET. Combined engineering skills of leading set makers and CBS-Hytron work hand in glove for you. CBS-Hytron tubes are originally set-engineered right into the sets of 9 out of 10 leading set manufacturers. No wonder CBS-Hytron is your logical matched-to-the-set replacement tube.

IT PAYS TO BE FUSSY! Just any standard brand won't do. If you want: Trouble-free, advanced performance. Maximum customer satisfaction. Minimum call-backs. More profit. Five big reasons point the way: Insist on CBS-Hytron!

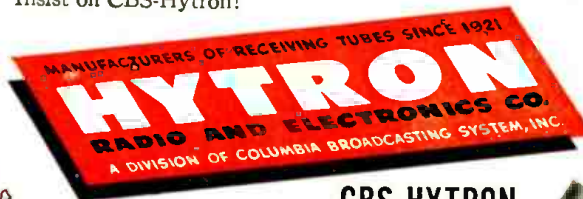

CBS-HYTRON
Germanium Diodes

Complete data yours for the asking. Write
CBS-Hytron, DANVERS, MASS., today.



Spot TV trouble symptoms at a glance
 fix them twice as fast!

Now! HANDLE UP TO 90% OF TV SERVICING BY PICTURE ANALYSIS

New short cut way of handling television service can save you hundreds of dollars worth of time



Ghirardi's PIX-O-FIX TV TROUBLE FINDING GUIDE

Covers 24 common television troubles identified by actual TV screen photos.

Covers 190 possible causes of these troubles identified and localized to the particular stage of the receiver where they are most likely to occur.

Covers 253 definite, easily understood remedies for these troubles.

Covers 4,500 words in CAUSE and REMEDY section to explain step by step what to do.

Just Out!

Hours of tedious, time-consuming troubleshooting can be cut to minutes! Repairs can be made twice as fast! Just "dial" the new Ghirardi's PIX-O-FIX TV TROUBLE FINDER GUIDE until the actual TV screen photo appearing in its "window" matches the screen picture on the defective set you are repairing. The proper Trouble Key Number also appears on the guide. This directs you to the tabulation giving all possible causes of this particular trouble and the stage of section of the receiver in which it is most likely to occur. But

this is only the beginning! The Pix-O-Fix Guide not only helps you locate the trouble quickly but then also shows you exactly how to fix it. Step-by-step repair instructions follow. In most cases, the particular component most likely to be faulty is specified. Quick tests to apply to it are explained. If part substitution is likely to be more effective than an instrument test, this is recommended. PIX-O-FIX is applicable to all television receivers. Operation is clear and simple. Money-back guarantee if you're not more than satisfied!

NOTE! Ghirardi's PIX-O-FIX is designed and sold as a professional TV service device for servicemen—NOT as a "fix-it-yourself" gadget for use by consumers.

Only \$1. 10 DAY Money back Guarantee

Dept. RN-13 Rinehart Books, Inc., Technical Div.
 232 Madison Ave., New York 16, N. Y.

Enclosed is \$1 for which please rush a PIX-O-FIX TROUBLE FINDER GUIDE. If not satisfactory, I will return it postpaid within 10 days and you guarantee to refund my \$1.

Name _____
 Street _____
 City, Zone, State _____
 PRICE OUTSIDE U.S.A. \$1.25 cash—same return privilege.

SURPLUS VALUES

MOBILE DYNAMOTORS (SMALL SIZE—BRAND NEW)

5.6 volts input, 425 volts @ 375 MA output	\$27.95 ea.
11.5 volts input, 425 volts @ 375 MA output	\$19.95 ea.

(ALL SUPPLIED WITH MOUNTING BRACKET)

G.E. RELAY CONTROL (Ideal for Model Controls, Etc.)

Contains a sigma midget 8,000 ohm. relay, (trips at less than 2 MA), high impedance choke, bi-metal strip, neon pilot and many useful parts. The sensitive relay alone worth much more than the total low price of \$1.25 each, 10 for \$9.90

WESTINGHOUSE OIL CONDENSER

10 M.F.D.—1000 VDC (Marked 440 VAC) \$1.95 ea.
 —A terrific bargain at

FILTER CONDENSER BARGAIN

8x8 M.F.D. 400 vdc oil compound filled. .95 each
 NEW, but scratched. Only

BAKELITE CASED MICAS

MFD	VDC	Price	MFD	VDC	Price
.001	600	5.18	.002	1200	.35
.002	600	.24	.024	1500	.65
.01	600	.26	.033	1500	.75
.02	600	.26	.02	2 kv	.90
.01	1 kv	.45			

PANEL METERS

0-10 MA AC	2.95	50 mfd 600 vdc	\$4.95
0-4 AMP RF	2.95	3.75 mfd 660 vac	2.45
0-3 METERS	6.95	15 mfd 1000 vdc	4.95
0-200 Microamp	5.95	1 mfd 1500 vdc	.89
0-500 Microamp	5.95	1 mfd 2500 vdc	1.75
0-2 MA	4.95	1 mfd 3600 vdc	1.95
0-100 VDC (IMA)	5.95	.1 mfd 7500 vdc	1.95
0-200 VDC (IMA)	5.95		
0-250 VDC (IMA)	5.95		
0-15 KVDC (500 UA) with multiplier	9.95		
4 METERS	12.95		
0-200 UA	8.95		
0-50 UA	12.95		

OIL CONDENSERS

50 mfd 600 vdc	\$4.95
3.75 mfd 660 vac	2.45
15 mfd 1000 vdc	4.95
1 mfd 1500 vdc	.89
1 mfd 2500 vdc	1.75
1 mfd 3600 vdc	1.95
.1 mfd 7500 vdc	1.95

H.D. FILTER CHOKES

6 My 90 ma	\$.79
6 My 500 ma	4.95
4 My 1 Amp 10KV insulation	22.50

WIRE WOUND RESISTORS

5 watt ohms: 25-50-84-200-2500	50.99 ea.
10 watt ohms: 25-40-1325-2K-4K	15 ea.
20 watt ohms: 150-300-750-1K-1.5K	20 ea.
2.5K-2.7K-10K-20K	.20 ea.
30 watt ohms: 100-2500-5300-18K	.22 ea.

N. Y. ADDRESS
PEAK ELECTRONICS CO.
 66 West Broadway, New York 7, N. Y.
 Phone WOOrth 2-5439



First...
 and Still
 Best!

The original — QUIETROLE

TRADE MARK REG. U.S. PAT. OFF.

Available in 3 sizes: 2 oz., 4 oz., 8 oz.

Here is the original, most reliable lubricant-cleaner on the market today . . . developed after years of research . . . not a cheap imitation. There is no substitute for QUALITY, try the FIRST . . . the non-conductive, non-inflammatory product. TODAY!

Carried by recognized jobbers . . . everywhere.



manufactured by
**QUIETROLE
 COMPANY**
 Spartanburg, South Carolina

International Short-Wave (Continued from page 61)

2345. 1130-1430, 0300-0430 (Fri. only), 0900-1000 (Fri. only), 0300-0400 (Sun. only); English 1230-1300 (Fri. only); lists channels of 9.746 (is nearer 9.737), 7.000, and 572.5 kc. (Kary, Pa.)

Angola—CR6RI, 4.770, Dundo, verified with card and letter; operates 1300-1430, also on 7.070, 100 watts. (N. Z. DX Times) *Radio Clube de Angola*, 11.862, noted to 1730 close-down. *Radio Clube de Benguela*, 9.165, heard closing with "A Portuguesa" 1500. *Radio Clube de Huila*, Sa da Bandeira, still noted near 10.048 to close-down 1530. (Pearce, England, others) CR6AA, 7.042, Lobito. *Radio-difusora do Lobito*, has recorded musical program at 1430; heard until 1530; believe closes 1600; good, clear signal in South Africa. (Ridgeway) WRH says Lobito uses 7.106 and 7.177 Sundays for English 1300-1400. Ridgeway, South Africa, reports *Radio Diamang*, Dundo, CR6RG, now on a new channel of 7.065, heard 1300-1430, good level.

Azores—Ponta Delgada is now scheduled 1500-1600 on 11.090; 1700-1900 on 4.865. (WRH)

Bechuanaland—ZNB, 8.236, Mafeking, is heard well 0600-0700, but is poor in the 1200-1430 session; relays SABC news 0615, 1200. (Ridgeway, South Africa)

Belgian Congo—OQ2AB, 11.90, Elizabethville, is scheduled Sundays only 0930-1100 (former schedule was 0800-1000); *Radio College*, OQ2AC, 7.198, Elizabethville, is noted daily 1130-1230; has call in English when closes; is parallel with 4.98. OTM4, 11.72A, Leopoldville, and OTM2, 9.382, open daily 1030 in parallel with OTM1, 6.295; close 1600. OTH, 9.211, is heard around 1230-1330 close-down. (Ridgeway, South Africa) *Radio Congo Belge*, 9.380, noted from tuning 1530 to close-down with Belgian National Anthem 1602 after closing announcements in French, Flemish; news in French 1545. (Pearce, England)

Belgium—Brussels is scheduled 0500-0700, 17.860, 21.510; 0700-0800, 21.510 (from 0715-0800 also on 15.335); 1200-1300, 9.745, 11.850; 1300-1630, 9.745, 11.850 (English 1515); 1630-1830, 9.745, 11.850; 1830-2000, 9.745, 9.767; 2000-2045, 9.745, 9.767 (relayed by OTC, 9.655, Leopoldville, Belgian Congo); 2045-2100, 9.745 (relayed by OTC, 9.655); 2100-2400, 9.745, 6.035 (relayed by OTC, 9.655).

Brazil—A new Brazilian was heard recently testing on 11.862A around 1445 to after 1600; called frequently as "Radio Clube do Estado de Bahia," and "Radio Sociedad de Bahia"; played recorded music; not heard lately, however. A Sao Paulo station is heard with strong signal on 6.022A from 2130; calls "Radiofonico Sao Paulo"; is heard until after 0000; another Sao Paulo station is being heard on 11.736

Depend on Mallory
for
Approved Precision Quality

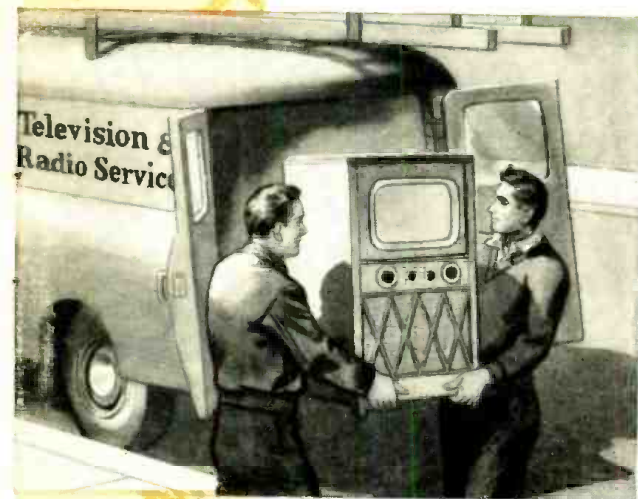

This Service Job Will Stay "Sold"!

For good reason, too. Mallory FP capacitors were used. They are engineered to duplicate the electrical characteristics of the original part in any TV or radio set that comes into your shop. They will give performance that's equal to . . . and often better than . . . the original equipment. You can count on Mallory FP's for precision quality . . . no call-backs.



Mallory FP's are the only fabricated plate capacitors available to the replacement market. They'll give you long lasting performance at high temperatures and greater ripple currents . . . even at 185° F. (85° C.).



When you use Mallory FP capacitors for all your service work, you can be sure that every job is right the first time. It just doesn't pay to take chances on capacitor performance. Always specify *brand* as well as rating when you order . . . ask for Mallory and watch your call-backs fall away to nothing. It costs no more to be sure with Mallory.

For plastic tubular replacements, ask your distributor for Mallory Plascaps®. They will put an end to premature shorts . . . leakage . . . off center cartridges . . . and unsoldered leads.

P. R. MALLORY & CO. INC.
MALLORY

CAPACITORS • CONTROLS • VIBRATORS • SWITCHES • RESISTORS
• RECTIFIERS • VIBRAPACK® POWER SUPPLIES • FILTERS

* Reg. U. S. Pat. Off.

APPROVED PRECISION PRODUCTS

P. R. MALLORY & CO., Inc., INDIANAPOLIS 6, INDIANA

if you want the
BEST MUSIC
possible... you want a

McIntosh

**WORLD'S FINEST
CUSTOM
AMPLIFIER!**



If you want greater listening pleasure from music... you want the laboratory perfection of the MCINTOSH AMPLIFIER... acclaimed by leading musicians, recording engineers and those laboratories where measurement of sound is critical.

Hear a demonstration of this unique, patented instrument... learn how easily it can become the heart of your own custom sound system... for radio, records, TV or tape. Write today for the name of a McIntosh dealer nearest you.

50W-2 amplifier

Get your FREE copy of
"LOST INSTRUMENTS"

A light-hearted, well illustrated, non-technical discussion of what to look for in high-fidelity reproducing equipment.

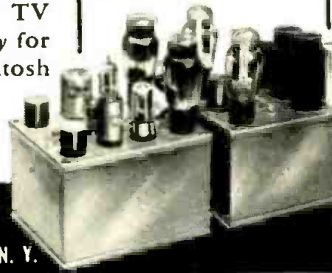

McIntosh LABORATORY, Inc.
322 Water St., Binghamton, N. Y.

**NOW—Get this expert SELF-TRAINING in
RADIO SERVICING**

by ABRAHAM MARCUS



co-author of famous "Elements of Radio" which has sold over 800,000 copies! Here is every detail you need to know about radio repair, replacement, and adjustment. Easy-to-understand, step-by-step self-training handbook shows you how to locate and remedy defects quickly.

Covers: TRF Receivers; Superheterodyne Receivers; Short-Wave Receivers and Converters; Multiband Receivers; Portable Receivers; Automobile Receivers; Communication Receivers; F-M Receivers; Power Supplies operated from AC, DC, Batteries, Motor-Generators, etc. Tells you the HOW and WHY of: Electron Tubes (Diode, Triode, Pentode, Beam Power, Thyatron, Phototube, Cathode Ray, etc.); Rectifier Circuits (Half-wave, Full-wave, Bridge, Voltage-Doubler, etc.); Detector Circuits (Diode, Triode, Regenerative, Superregenerative, Infinite-impedance, etc.); Amplifier Circuits (Audio, Radio, I-F, Video, D-C, etc.); Oscillator Circuits (Hartley, Colpitts, Crystal, Transitor, Multivibrator, Sweep-circuit etc.); Control Circuits (Volume, AVC, DAVC, Tone, Noise-Suppression, Automatic Tuning, Automatic Frequency Control, etc.).

All in one big volume — easy to read. 16 Big Chapters. 121 Sections. 400 "Show-How" Diagrams. 775 pages of practical radio instruction.

Explains how to use testing instruments such as: meter, vacuum-tube voltmeters, ohmmeters, bridges, multimeters, signal generators, tube checkers, cathode-ray oscilloscopes, etc. Over 100 pages and 69 illustrations in this section alone!

Get this authoritative radio repair handbook today! Coupon below brings you "Radio Servicing" on FREE trial for 10 days. Mail it NOW.

PRENTICE-HALL, Inc., Dept. M-RTN-153
70 Fifth Ave., New York 11, N. Y.

Send me, for 10 DAYS' FREE TRIAL, "Radio Servicing," by Abraham Marcus. I will return it in ten days and pay nothing—or keep it and send \$1.95 down (plus postage) and \$2 monthly for 2 months.

Name
Address
City State
() SAVE! Send \$6.95 WITH COUPON—we pay postage.

AMPERITE
Studio Microphones
at P.A. Prices

Ideal for
BROADCASTING
RECORDING
PUBLIC ADDRESS

"The ultimate in microphone quality," says Evon Rushing, sound engineer of the Hotel New Yorker.

• Shout right into the new Amperite Microphone—or stand 2 feet away—reproduction is always perfect.

• Not affected by any climatic conditions.
• Guaranteed to withstand severe "knocking around."



Models
RBLG—200 ohms
RBHG—Hi-imp.
List \$42.00



"Kontak" Mikes
Model SKH, list \$12.00
Model KKH, list \$18.00

Special Offer: Write for Special Introductory Offer, and 4-page illustrated folder.

AMPERITE Company, Inc.
561 BROADWAY • NEW YORK 12, N. Y.
Canada: Atlas Radio Corp., Ltd., 560 King St. W., Toronto

with good signals from 1530. (Ridge-way, South Africa) PRL7, 9.72. Rio de Janeiro, leaves this channel daily 1730. (Bellington, N.Y.) PRL9, 6.147, the other *Radio Nacional* outlet, is usually good level around 2000, some QSB. (Gaylord, Wn. State)

Bulgaria—Sofia has replaced 15.330 with 9.700A; has *English* for North America 2000-2030. (Niblack, Ind., Kary, Pa. others)

British Guiana—*Radio Demerara*, ZFY, 5.980A, has been heard with news 1945; good level in Indiana. (Hord) When this was compiled the Cable and Wireless, Ltd., transmitter ZJA6, 15.075, Georgetown, was being heard throughout the world with relay of sports events (cricket, racing) from ZFY from as early as 1000 to around 1600; may have ceased these special broadcasts by now.

Burma—*Radio Rangoon*, 4.775, is good level in New Zealand 1000-1015 with *English*. (N. Z. DX Times) Noted on 9.54 from 0930 with programs in *English*, recorded music; has news 1000 by man, followed by weather report and program preview for next day; closes 1015A; calls "This is the Burma Broadcasting Service." (Ridge-way, South Africa)

Ceylon—*Radio Ceylon*, has strong signal 0100 with native vocal music; heard in *English* 0200. (Pearce, England) Still noted opening 2045 on 11-975. (Sanderson, Australia, others) This outlet normally closes 1145A but on Thursdays runs to 1215 closedown. (Fuller, R.I.) VOA relays are scheduled for 15.120 at 0730-0830 and on 11.975 at 1030-1100, both to India-Pakistan.

Chile—Punta Arenas, CE920, 9.200A, is heard with fair signal 2045; gives call 2100, closes 2200. CE1174, 11.74, Santiago, has very strong signal 2230 to close at 2400. *Radio Minería*, 11.73, Santiago, is heard at 2300 to after 2330; gives call at 2300 and 2315; signal deteriorates after 2330. (Ridge-way, South Africa)

China—*Radio Peking*, 15.06V, noted with news 0400 and 0830, stronger 0400. (Pearce, England) Revised schedules for *English* periods from *Radio Peking* are 1730, 6.100, 7.500, 9.040, 10.260, 11.690, 15.060, 15.170; 0400, 10.260, 11.690, 15.060; 0830, 11-690, 15.060. (N. Z. DX Times)

Colombia—*Radiodifusora Nacional de Colombia en Bogota* noted moved to 6.183 from 6.203. (Stark, Texas)

Curacao—PJC2, 5.010, Willemstad, noted at fair level with *English* session on Wednesdays 2000-2030. (Croston, Pa.)

Cyprus—Asharq-al-Adna, Limassol, noted 2255 on 6.790, 6.170. (Kary, Pa.)

Czechoslovakia—Prague is heard on 9.550 with *Radio Moscow* relay 1820-1930, with own program 1930-2030, and then resuming relay from Moscow; is directed to North America. (Grenell, Ohio) Has second period for North America at 2300. (Bellington, N.Y., others)

Denmark—OZU, 7.26, relays Home Service on Mon. and Fri. 1315-1615, other days 1240-1615. OZF, 9.52, is

BUY TEST EQUIPMENT ON THIS RADICALLY NEW TIME PAYMENT PLAN

NO INTEREST!! - NO CARRYING CHARGES!!

USE CONVENIENT TIME PAYMENT ORDER BLANK BELOW

Superior's New Model 770

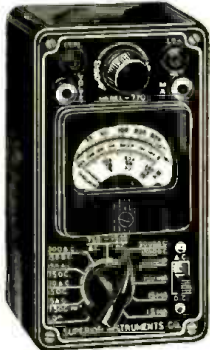

Model 770 is an accurate pocket-size V.O.M. Measures only 3/16" x 5/16" x 2 1/4".

VOLT-OHM MILLIAMMETER

Sensitivity—1000 ohms per volt

Uses latest design 2% accurate 1 Mil. D'Arsonval type meter. • Same zero adjustment holds for both resistance ranges. It is not necessary to readjust when switching from one resistance range to another. This is an important time-saving feature never before included in a V.O.M. in this price range. • Housed in round-cornered, molded case. • Beautiful black etched panel. Depressed letters filled with permanent white. Insures long-life even with constant use.

- Specifications:
- 6 A.C. VOLTAGE RANGES: 0-15/30/150/300/1500/3000 Volts.
 - 6 D.C. VOLTAGE RANGES: 0-7.5/15/75/150/750/1500 Volts.
 - 4 D.C. CURRENT RANGES: 0-1.5/15/150 MA. 0-1.5 Amps.
 - 2 RESISTANCE RANGES: 0-500 Ohms 0-1 Megohm.

\$14.90 NET The Model 770 comes complete with self-contained batteries, test leads and all operating instructions.

Superior's New Model TV-11

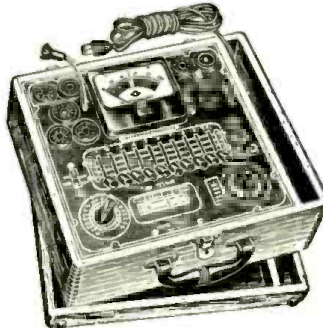

Operates on 105-130 Volt 60 Cycles A.C. Hand-rubbed oak cabinet complete with portable cover

\$47.50 NET

• Uses the new self-cleaning Lever Action Switches for individual element testing. Because all elements are numbered according to pin number in the IMA base numbering system, the user can instantly identify which element is under test. Tubes having tapped filaments and tubes with filaments terminating in more than one pin are truly tested with the Model TV-11 as any of the pins may be placed in the neutral position when necessary. • Uses no combination type sockets. Instead individual sockets are used for each type of tube. Thus it is impossible to damage a tube by inserting it in the wrong socket. • Free-moving built-in roll chart provides complete data for all tubes. • Phono Jack on front panel for plugging in either phones or external amplifier detects microphonic tubes or noise due to faulty elements and loose external connections.

Superior's New

JUNIOR SUPER-METER

MOST COMPLETE AND COMPACT MULTI-SERVICE INSTRUMENT EVER DESIGNED

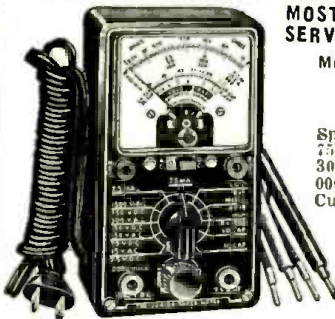

Handsome round cornered molded bakelite case 3 1/2" x 5 7/8" x 2 1/4" complete with all test leads and instructions

\$21.40 NET

- Measures: * Voltage * Decibels
* Capacity * Resistance
* Current * Inductance
* Reactance

Specifications: D.C. Volts: 0-7.5/75/150/750/1500 Volts. A.C. Volts: 0.15/150/300/1500/3000 Volts. Resistance: 0-10,000/100,000 ohms. 0-10 Megohms. D.C. Current: 0-7.5/75 Ma. 0-7.5 amps. Capacity: .001 Mfd.—2 Mfd. 1 Mfd.—20 Mfd. Electrolytic Leakage: Reads quality of electrolytics at 150 Volt test potential. Decibels: -10 Db to +18 Db. +10 Db. to +38 Db. +38 Db. to +58 Db. Reactance: 15 ohms—25 K ohms 15 K ohms—2.5 Megohms. Inductance: .5 Henry—50 Henrys 30 Henrys—10 K Henrys. Plus Good-Bad scale for checking the quality of electrolytic condensers.

Superior's New

TV BAR GENERATOR

THROWS AN ACTUAL BAR PATTERN ON ANY TV RECEIVER SCREEN!!



TV Bar Generator comes complete with shielded leads and detailed operating instructions

\$39.95 NET

Connects direct to antenna post. No connection inside receiver.

Features.—Can be used when no stations are on the air. • Provides linear patterns to adjust vertical and horizontal linearity • Provides vertical and horizontal sweep signals • Provides signal for testing video amplifiers.

Superior's New Model 670-A

SUPER-METER

A COMBINATION VOLT-OHM MILLIAMMETER PLUS CAPACITY REACTANCE INDUCTANCE AND DECIBEL MEASUREMENTS

SPECIFICATIONS:

- D.C. VOLTS: 0 to 7.5/15/75/150/750/1,500/7,500 Volts.
- A.C. VOLTS: 0 to 15/30/150/300/1,500/3,000 Volts
- OUTPUT VOLTS: 0 to 15/30/150/300/1,500/3,000 Volts.
- D.C. CURRENT: 0 to 1.5/15/150 Ma. 0 to 1.5/15 Amperes.
- RESISTANCE: 0 to 1,000/100,000 Ohms 0 to 10 Megohms
- CAPACITY: .001 to 1 Mfd. 1 to 50 Mfd. (Quality test for electrolytics)
- REACTANCE: 50 to 2,500 Ohms, 2,500 Ohms to 2.5 Megohms
- INDUCTANCE: .15 to 7 Henrys 7 to 7,000 Henrys
- DECIBELS: -6 to +18 +14 +38 +34 to +58

\$28.40

The Model 670-A comes housed in a rugged, crackle-finished steel cabinet complete with test leads and operating instructions. Size 6 1/4" x 9 1/2" x 4 1/2".

ADDED FEATURE: The Model 670-A includes a special GOOD-BAD scale for checking the quality of electrolytic condensers at a test potential of 150 Volts.

NEW TIME PAYMENT PLAN ORDER BLANK

MOSS ELECTRONIC DISTRIBUTING CO., INC.
Dept. B-42, 38 Murray Street, New York 7, N. Y.

Please send me the units checked below. I am enclosing the down payment with order and agree to pay the monthly balance as shown. It is understood there will be no carrying interest or any other charges, provided I send my monthly payments when due. It is further understood that should I fail to make payment when due, the full unpaid balance shall become immediately due and payable.

- MODEL 770 Total Price \$14.90
\$2.00 down payment. Balance \$2.00 monthly for 6 months.
- MODEL TV-11 Total Price \$47.50
\$11.50 down payment. Balance \$6.00 monthly for 6 months.
- JUNIOR SUPER METER Total Price \$21.40
\$5.40 down payment. Balance \$4.00 monthly for 4 months.
- TELEVISION BAR GENERATOR Total Price \$39.95
\$9.95 down payment. Balance \$5.00 monthly for 6 months.
- MODEL 670-A Total Price \$28.40
\$7.40 down payment. Balance \$3.50 monthly for 6 months.
- I enclose \$..... as down payment.
- Ship C.O.D. for the down payment.

Signature

Name

Address

City..... Zone..... State.....

teamed together for

Better TV Picture Quality

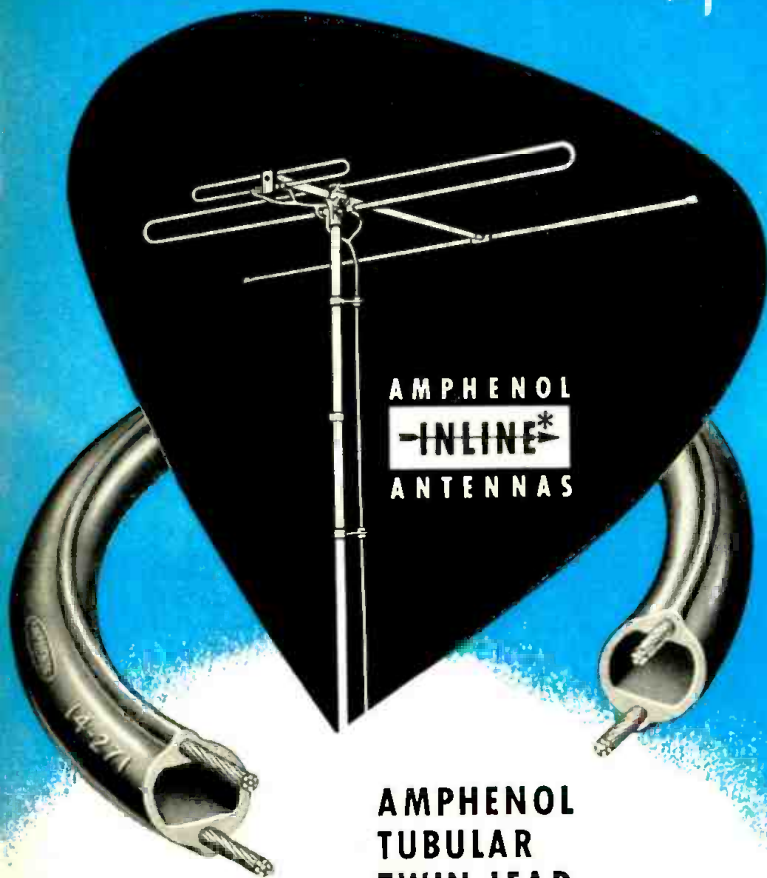

AMPHENOL TUBULAR TWIN-LEAD

This combination of the famous Amphenol In-Line Antenna and the extremely low-loss Amphenol Tubular Twin-Lead permits any TV set to present the best picture it possibly can.

The Amphenol In-Line is the superior all-channel antenna. The In-Line has uniform gain over the entire range of VHF channels—less variation than the 3 decibel change which determines "fuzziness." Its strong forward reception lobe practically eliminates any pick-up of unwanted secondary or reflected signals.

The Amphenol Tubular Twin-Lead provides very low-loss and constant impedance. The tubular construction minimizes the effect of moisture and dirt deposits on the concentrated field of energy and ends weather interference. Because of these characteristics, Amphenol Tubular Twin-Lead has been recommended by leading TV manufacturers and authorities for any installation where UHF is, or will be, available.



This illustration clearly shows that the concentrated field of energy between the two conductors, which are 7 strands of #28 copper weld wire, is contained by the tubular construction. This important field of energy is unaffected by any exterior conditions.

Nominal Impedance	300 ohms
Velocity of Propagation	84%
Attenuation db/100 feet	30 mc — .63
	60 mc — .93
	100 mc — 1.25
	200 mc — 1.82
	400 mc — 2.7
	500 mc — 3.0
	700 mc — 3.6
	900 mc — 4.2

AMERICAN PHENOLIC CORPORATION
1830 SOUTH 54TH AVENUE • CHICAGO 50, ILLINOIS

scheduled to South America, Mon., Wed., Fri. 1730-1830; to North America daily 2030-2130, 2200-2300; for Faroe Islands, Sun. only 0900-1000; for Danish ships Mon., Wed., Fri., 1830-1850, 2130-2150, 2300-2320, and Tue., Thur., Sat. 1200-1220. OZH4, 15.165, for Middle East, India, Burma, Malaya, Indonesia, Tue., Thur., Sat. 0900-1000, for Danish ships same days 1000-1020. OZH, 15.18, for Far East, Australia, New Zealand, Tue., Thur., Sat. 0400-0500, for Danish ships same days 0500-0520; for Africa and Near East, Mon., Fri., 1200-1300. Reports are sought. (Gade-Joergensen, Denmark)

Dutch New Guinea—Radio Omroep Nieuw Guinea, 7.126, Hollandia, lists schedule of 0430-0700. Saturday also 2100-2300. (Scheiner, N.J.)

Ecuador—HCJB, 11.915, noted 2100-2130 with religious program. (Simpson, Kans.) HC4AS, 4.203, Bolivar, "La Voz de las Caras," is noted signing off weekdays 2330. (Robbins, Ind.)

El Salvador—YSASA, 11.95A, San Salvador, noted around 1830. (Bellington, N.Y.) Gives medium-wave call of YSAS; heard by 0930 and goes past 1700. (Stark, Texas) YSDR, 4.797, Santa Ana, noted with fair level signing off 2210. (Robbins, Ind.)

Ethiopia—The schedule of Radio Addis Ababa, 15.040AV, appears to be rather irregular; has been heard signing on in English 1102; on another day had a missionary program in English when tuned 1032; is identifying more frequently in English now, and some days has English news 1403A; sign-off varies. (Pearce, England) Was recently measured 15.036, but varies. Noted parallel on 6.42, latter quite good from 1230 onwards. (Ridgeway, South Africa) QRA is Box 1364, Addis Ababa, Ethiopia. (N. Z. DX Times)

Finland—OIX2, 9.555, Helsinki, heard 2345 with Finnish news and music. (Sanderson, Australia) Noted on this channel opening 2200 with news. (Annala, Oregon)

France—Paris noted signing on in French with "La Marseillaise" 0915 on 15.400 and 17.850. (Pearce, England) Paris is scheduled to Britain daily 0245 on 7.240, 6.145; 1445 on 11.970; Sundays 0800-0900 on 7.240. (Catch, England)

Fr. Equatorial Africa—Radio Chad, Brazzaville, is noted on 15.596 at 0030-0130; Radio A.E.F. is heard on 9.96, 15.596, 6.024 at 1200-1500. (Ridgeway, South Africa)

Fr. Morocco—Radio Maroc, 6.006, Rabat, is fair to good level around 0200-0300 with native session. (Saylor, Va.)

Fr. West Africa—Radio Francaise Africa Occidentale, 9.560, Dakar, noted signing on in French after a march at 0200, then in native African talks and music; noted on 11.896 at 0230. (Pearce, England) The 11.896 outlet opens 1400 with French programs; high level to 1800 closedown. (Ridgeway, South Africa) The 9.560 outlet is heard as early as 1530 to 1730 when closes with martial tune. (Levy, N.Y., Kary, Pa., others)

Germany—Nordwestdeutscher Rundfunk, Hamburg, noted on 11.795 in parallel with 7.290 when tuned 0900, had choral concert from Hanover; was strong on 6.270 with orchestral music when tuned 0345. Berlin, 7.150, Demokratische Republic, noted 0115 with news in German, call 0121, then dance and light music. (Pearce, England)

Greece—Kozani, 7.970, is heard in Sweden at 1335 with recorded music; CWQRM. (Malmo DX-aren, Sweden) Larissa, 6.760, relays news in Greek from Radio Athens 2330-2340. Athens Forces Station, 6.330, noted with recorded music 2357. (Kary, Pa.) Radio Athens, 7.300, heard with news 2300; on 9.607 with news (to North America) 1935-1950A. (Pelegri, N.Y.)

Guatemala—Officials list TGN, 580 kc.; TGNA, 5.9525; TGNB, 9.668, and TGNC, 11.850; say "for our English short-wave broadcast we use only the call TGNA." (Ferguson, N.C.)

Hong-Kong—ZBW3, 9.525, noted 0430 with "Cantonese by Radio," then musical interlude. (Sanderson, Australia) Noted 0900 at good strength relaying BBC's "Radio News-reel." (Balbi, Calif.)

India—Latest schedules received airmail from Delhi for All India Radio's External Services are—To East and Southeast Asia 1930-2000, 11.850, 9.630; 2030-2200, 17.740, 15.160; 0600-0815, 17.740, 15.190; 0830-0945, 15.190, 11.780.

(Continued on page 136)

Oscilloscopes
(Continued from page 34)

instruments falls within 60 kc. to 100 kc. For most radio and TV service applications it is seldom necessary to go beyond 30 kc.

In order to work with any pattern presented on the screen, the pattern should be held stationary. With the "Range Frequency" control, it is possible with some patience to adjust the frequency of the saw-tooth generator until it exactly equals (or is an exact multiple of) the frequency of the applied vertical signal. But, unless this control is constantly adjusted, the frequency of the saw-tooth generator will change (even if only a few cycles) and the pattern will drift.

To keep the trace or pattern steady without constant adjustment of any control, a portion of the incoming signal is fed to the saw-tooth generator and serves to lock the generator in. The "Sync" control enables the operator to vary the amount of synchronizing signal fed to the sweep oscillator. The optimum position for this control is at that point where the smallest amount of sync signal causes the pattern to become stationary. Thus, you start with the "Sync" control at zero and slowly turn it to the right (clockwise) until the pattern locks-in. (It is important before using the "Sync" control to adjust the "Range Frequency" until the pattern is close to being stationary.)

The three controls just described, and especially the "Sync" control, are to be used in conjunction with the "Function" switch situated just below them. The "Function" switch is a 5-position switch which controls the power input and selects the desired horizontal deflection signal. The power is off in the "Off" position of the switch and is on in the remaining four positions. In addition, the switch makes the following connections in its 5 positions:

1. "Off"—Opens the circuit for the power input.

Electronic Measurement Corp.'s Model 600.

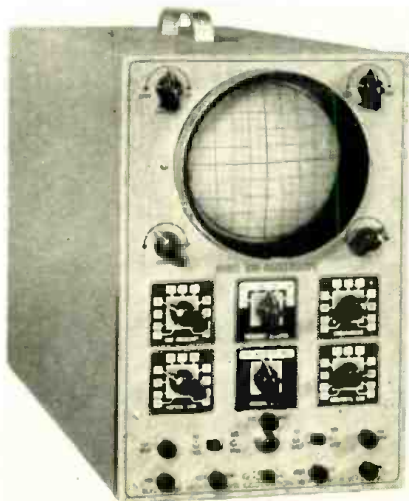

Service Men - BOOST YOUR INCOME - SAVE HUNDREDS of DOLLARS

—these TRANSVISION Instruments are *real necessities*—a "must" for your shop if you are not to throw good money away.

Here's why: —

1. **TESTING**—you can accurately test Cathode Ray Tubes.
2. **REACTIVATING**—you can save many dim or worn out tubes by reactivation.
3. **SPARKING OUT ELECTRICAL LEAKAGE** — many Cathode Ray Tubes develop electrical leakage. This can now be repaired.

CRT TESTER-REACTIVATOR-SPARKER

3 Instruments in 1, making a complete CRT testing and repair unit. Compact, dependable, profitable.

It's a combination of the Transvision **TESTER-REACTIVATOR** plus a **SPARKER** in one handy instrument. It **TESTS PICTURE TUBES**—measures Cathode emission, locates shorts between elements, locates high resistance shorts or leakage as high as 3 megohms. **REACTIVATES DIM TUBES. SPARKS OUT ELECTRICAL LEAKAGE** in picture tubes.

Fully Guaranteed

\$34⁹⁵
net



CRT TESTER-REACTIVATOR

2 Instruments in 1. As a **REACTIVATOR** it renews brightness, sharpness, and detail of old dim CR Tubes, without removal of tube. It's also an accurate **TESTER: Measures Cathode emission, locates shorts between elements, locates high resistance shorts or leakage as high as 3 megohms.** 110V-60 cycles; wt. 3 lbs. Fully Guaranteed.

\$19⁹⁵
net

CRT TESTER-SPARKER

2 Instruments in 1. As a **PICTURE TUBE SPARKER**, it sparks out electrical leakage between elements. *Saves many picture tubes and small tubes* which would usually be discarded. Cathode-grid leakage is an especially common occurrence. The *Sparker* also gives a rapid check of gas condition of the tube.

As a **TESTER** it provides a variable 8,000-14,000 D.C. supply—useful for analyzing hard-to-solve deflection problems. Fully Guaranteed.

\$25⁹⁵
net



FIELD STRENGTH METER

for better TV installations. Make more efficient, more profitable TV installations, and save half the work, with the Transvision Field Strength Meter. *Especially good for fringe areas*—measures field strength as low as 10 microvolts. A great buy at this low price.

Model FSM-1, complete with tubes

\$59
net

Order direct from **TRANSVISION, INC.**, New Rochelle, N. Y.

RUSH THIS COUPON.....
TRANSVISION, INC., Dept. RN-135 NEW ROCHELLE, N. Y.

Please send

\$..... deposit enclosed; send C.O.D. in full enclosed; send prepaid.

Name

Address

GIANT BARGAINS BECAUSE WE'RE

SPECIALISTS in TV ANTENNAS
ACCESSORIES, EQUIPMENT FOR ALL LOCATIONS

Amazing New Motorless
TV ANTENNA

All Channel TV RECEPTION IN ALL DIRECTIONS

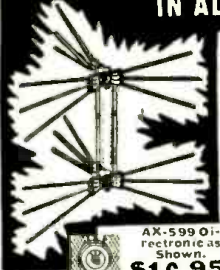

**Rocket
DIRECTRONIC
MOTORLESS
TV ANTENNA**
360° Electrically
Switched Beam

AX-599 Di-
rectronic as
Shown.
\$16.95

Beam Selector

Provides same clear pictures as rotating aerials costing 4 times as much. Electrically beams in all directions with full 360° rotation. You select direction with Directronic Beam Selector located at set. Model AX-599 stacked array includes 18 hi-tensile aluminum elements, 1 set connecting studs, Universal U-Clamps for mast, Directronic Beam Switch, and 75 feet of TR-X lead-in.
Model AX-59 Directronic 8-element Single. **\$10.35**

Rocket ALL CHANNEL CONICALS



This sturdy, all-aluminum constructed TV antenna is designed for broad-band reception on all TV channels, plus FM. High Gain, 4 to 1 front to back ratio. All channels 2-13. Uni Directional. Maximum signal to noise ratio. For use with 75-150-300 ohm lines. Low inception angle. Complete with all hardware—less mast.

Single Bay Array. **\$ 3.95**
2 Bay Array with Tie Rods. **8.65**
Fringe Area 4 Bay Array including 4 Bay Stacking Bars. **18.95**

FREE
OF
EXTRA COST

With any order of \$10 or more you will receive our Rocket 7 Ft. Interlock Line Cord. Permits adjustment, testing, repair of set while operating with back removed. When ordering state that you want this gift. Don't delay as quantities are limited. Only one given to a customer.

ROCKET 5 ELEMENT YAGI

Excellent Pictures in Fringe Areas

Designed for high gain with minimum interference from cross and noise due to directive pattern. Produces clear sharp pictures. 5 Heavy aluminum elements include one folded dipole, one reflector, three directors. Strong molded insulator. Non-slip mast clamp. Completely pre-assembled, less mast.

Channels 7 through 13. **\$3.95**
Channels 5 or 6. **\$6.95**
Channels 2, 3, or 4. **\$7.95**

When ordering, specify exact channel number desired.

Rocket 35-foot Mast Kit

Economy mast kit contains 3-10' seamless duralcoted 1 1/2" OD masts, one 5' mast, 300 feet of 6/20 galvanized steel guy wire, and everything else needed including guy rings, mast connectors, insulators, cable clamps, guy hooks, and swivel mounting base.

35-Foot Mast Kit \$15.95 **25-Foot Mast Kit \$11.95**

LOWEST PRICES ON ANTENNA ACCESSORIES

Mast Steel (Duralcoted 5' crimped 1 1/2" O.D.)	\$1.05
Mast Steel (Duralcoted 10' 1 1/2" O.D.)	1.95
Chimney Mount Complete with Straps	1.19
Peak Roof Saddle (will take up to 1 1/2" O.D.)	1.59
Lightning Arrestor-TV	.69
Galvanized Steel Guy Wire—8/20	1 1/2 ft.
Galvanized Steel Guy Wire—11/20	1 1/2 ft.
Rocket Twin-Lead—7/28 stranded	2 ft.
UTP-type Tubular 300 ohm Twin-Lead	4.95
100' coil	20.95
Rocket Open Line Twin-Lead (500' reel)	.10
Mast Stand-off Insulators—3"	.03
Stand-off Screw Insulators—3"	1.49
Wall Bracket—6" clearance	2.49
Wall Bracket—12" clearance	

ALL PRICES F.O.B. CLEVELAND, OHIO
Do not remit more than complete purchase price. Pay shipping charges on receipt of goods. 25% deposit on C.O.D. orders, please. Money-back guarantee.
Prices Subject to Change Without Notice

National Electronics OF CLEVELAND THE HOUSE OF TV VALUES

101 Delco Bldg. Cleveland 3, Ohio



the
Engineered
Product

**Perma-Power
TV TUBE
BRITENER**

**extends useful life
of older TV tubes!**

manufactured by

Perma-Power COMPANY

Chicago 25, Illinois

Manufacturers of Electronic Equipment Since 1928



**JCT
Meter-Gun**

An extra hand for Radio
and Television Technicians

- PRECISION VOLT-OHMMETER IN GUN FORM.
- ILLUMINATES AREA UNDER TEST.
- FLEXIBLE PROBE FOR REACHING TEST AREAS.
- METER READING AND TEST POINT VISIBLE IN ONE GLANCE.
- ALL WORK POSSIBLE WITH ONE HAND.
- TRIGGER RANGE SELECTOR
- Makes Service More Efficient
- Increases Profits ● Fully Guaranteed

Ideal For
TV TECHNICIANS ● MAINTENANCE TECHNICIANS
SOUND TECHNICIANS ● HAMS
BROADCAST ENGINEERS ● EXPERIMENTERS

Available at your nearest parts jobber

Model 3A 1,000 ohms/volts.
including probe and ground lead - **\$32.75**

Model 3B - 20,000 ohms/volts.
including probe and ground lead - **\$35.50**

**JERSEY CITY TECHNICAL
LABORATORY**
880 Bergen Ave. Jersey City 6, N. J.

2. "Int. Sync"—A linear (or saw-tooth) sweep voltage is applied to the horizontal amplifier. At the same time, a portion of the "Vert. Input" signal is fed into the sweep oscillator through the "Sync" control. If the frequency of the applied (or "Vert. Input") signal is near sweep frequency, the pattern can be locked steady on the screen of the cathode-ray tube.

3. "Line Sync"—The saw-tooth sweep voltage is still applied to the deflection plates through the horizontal amplifier. However, now, the synchronizing voltage is not taken from the incoming signal, but from the 60-cycle power line. The 60-cycle voltage is injected into the sweep oscillator through the "Sync" control and therefore locks the saw-tooth oscillator in sync with the line frequency. This is usable for applied signals having frequencies of 20, 30, 60, 120, and 180 cycles, and for other subharmonics of 60 cycles.

4. "Ext. Sync"—The saw-tooth sweep voltage is still active. However, now, a synchronizing pulse can be obtained only from an external signal injected into the sweep circuit through the "Ext. Sync" terminal. The setting of the "Sync" control still determines how much of this sync pulse reaches the saw-tooth oscillator.

5. "Horiz. Amp."—In this position the saw-tooth voltage of the oscilloscope's sweep generator is disconnected from the horizontal amplifier and the beam is stationary at the center of the screen in a small, round spot. To obtain any horizontal deflection of the beam, an external signal must be applied to the "Horiz. Input" terminal at the front of the oscilloscope. This signal will be amplified by the horizontal amplifier and applied to the horizontal deflection plates of the cathode-ray tube.

The most frequent use that the TV technician will make of the "Horiz. Amp." position will be in TV or FM receiver alignment. Nearly all sweep signal generators supply their own 60-cycle deflection voltage for the oscilloscope and this should be used in preference to any 60-cycle saw-tooth or sine-wave voltage the oscilloscope may be capable of supplying. (An exception to this occurs when the oscilloscope contains specific provision, in the form of a phasing control, enabling it to develop a properly phased pattern.)

The "Function" switch is a convenience that is not universally employed. In a number of oscilloscopes, the turning on or off of the power is handled by a separate toggle switch. Another two-position switch might then govern whether the sync voltages are internally or externally obtained. Or, internal sync, external sync, and line sync might be combined in a three-position switch. There are a number of ways of handling this situation and they vary from manufacturer to manufacturer.

On either side of the "Function" switch in Fig. 1 are the gain controls for the vertical and horizontal ampli-

Start This New Year RIGHT!

... BY GETTING YOUR EQUIPMENT FROM *Walter Ashe*



HICKOK MODEL 539-A

Professional Laboratory type tube tester. Shpg. wt. 39 lbs.

Net price Only **\$271.50**

HICKOK MODEL 209-A
Electronic Volt-Ohm-Capacity-Milliammeter. Features large 9 inch meter. Shpg. wt. 25 lbs.

Net price Only **\$132.50**

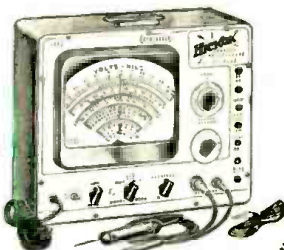

HICKOK MODEL 288-X
Universal Crystal Controlled Signal generator. Shpg. wt. 40 lbs.

Net price Only **\$186.00**



Walter Ashe
RADIO CO.
1125 PINE ST. • ST. LOUIS 1, MO.

All prices f. o. b. St. Louis

Phone Chestnut 1125

FREE CATALOG!

Send for your copy today.

WALTER ASHE RADIO CO. R-1-53
1125 Pine St., St. Louis 1, Mo.

Send complete information and price on _____
(indicate make and model!)

May want to trade _____

Mail 1953 Catalog containing complete line of Test Equipment.

Name _____

Address _____

City _____ Zone _____ State _____

B&W**MODEL
600**

Dip Meter

- ★ Frequency Range—1.75 to 260 MC. in 5 Bands
- ★ Adjustable Sensitivity Control
- ★ Wedge-shaped for Easy Access in Hard-to-get-at Places
- ★ Rust Proof Chassis, Sturdy Aluminum Case
- ★ Monitoring Jack and Diode Switch
- ★ Powered by 110 V. A.C. Line



PRICE
\$48⁰⁰
net

A HIGHLY USEFUL INSTRUMENT FOR THE

Service Man • Experimenter
Lab. Technician • Engineer • Amateur

The New B & W Model 600 Dip Meter provides you with a convenient means of doing the job in a minimum of time with dependable accuracy.

It is an extremely sensitive and reliable piece of test equipment having innumerable uses in the Ham Shack, Service Shop, Electronic Laboratory, or Production Plant.

Armed with this versatile and indispensable instrument, you eliminate the guess-work during measurement of—tank circuit frequencies, antennas, feed line systems, parasites, and other pertinent tuned circuit characteristics, with speed and accuracy.

The handy instruction manual furnished with each instrument covers full information on how to use the Model 600 as an Absorption Meter, Auxiliary Signal Generator, R. F. Signal Monitor, and several special applications as well. See it at all leading electronic parts distributors throughout the U. S. A. and Canada; or write for descriptive bulletin.

BARKER & WILLIAMSON, Inc.
237 Fairfield Ave., Upper Darby, Pa.

fiers and their function is indicated in Fig. 1. Just beneath the "Vert. Gain" control is the "Vert. Attenuator" switch. This is a voltage divider network which limits the amount of vertical input signal reaching the first vertical amplifier. There are four switch positions labeled: .5, 5, 50, and 500 volts. These figures indicate the maximum value of input signal that should be applied with the switch in each position. Thus, with the attenuator switch in the .5 position, no signal having an amplitude greater than .5 volt r.m.s. should be applied to the "Vert. Input" terminal (and ground). Excess voltage on any range may produce a distorted pattern or may possibly cause damage. On the other hand, setting the control pointer too high—say at 500 volts for an input voltage of 30 volts—will produce a pattern which is too small. In other words, do not set the control too high or too low.

The "Vert. Attenuator" switch receives the applied signal before the "Vert. Gain" control. Hence, the attenuator switch may be considered as a rough adjustment with the gain potentiometer as its vernier.

The last remaining control on the front panel of this instrument (Fig. 1) is the "Horiz. Sens." switch. This 2-position switch is in series with the line from the "Horiz. Input" terminal to the horizontal amplifier. The "Horiz. Sens." is marked "High" for the closed switch position. At this setting the full signal is fed to the horizontal amplifier. The system is thus most sensitive with the switch in the "High" position and affords any applied signal maximum amplification (provided, of course, that the "Horiz. Gain" control is turned up, too).

The "Horiz. Sens." switch is marked "Low" for the open position of the switch and a 12-megohm resistor is placed in series with the input to the "Horiz. Gain" control.

These markings of "High" and "Low" can be very confusing since they refer to the sensitivity of the horizontal amplifier system and not to the applied voltages. Actually, strong voltages are applied to this system

(Top right) General Electric's Type ST-2A 5" scope. (Center) G-E's Model ST-2B 5" unit. (Bottom right) The same company's Type ST-2C 5" model. (Below) G-E's YNA-4.

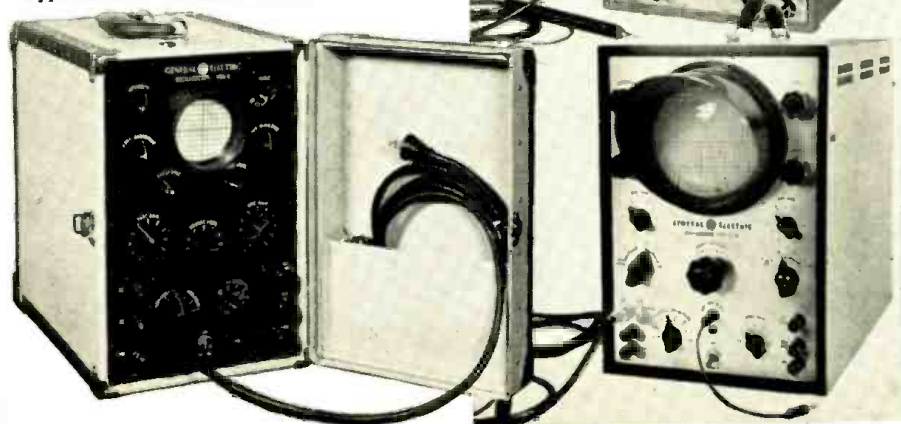

with the switch in the "Low" position since with a strong voltage, less amplification is required. On the other hand, with a weak applied signal, the "Horiz. Sens." switch would be set "High."

Not all scopes possess attenuator controls. In some instruments the applied voltage goes directly to its respective amplifier. When using these instruments be careful not to apply too much voltage otherwise distortion and possible damage may occur. The safe maximum voltage that the oscilloscope can handle will usually be stated in the instruction manual. If it is desired to view the waveform of high voltages, reduce them first to a suitable value by the use of a resistive network such as shown in Fig. 3.

At the bottom of the oscilloscope in Fig. 1 there are six terminal posts through which connections are made to the instrument circuits. Two are for ground; the functions of the other posts are indicated in the illustration.

Alternate Control Names

The foregoing controls have all been part of one instrument. While other instruments have essentially the same



TUBES

ALL TUBES are guaranteed for one year individually boxed. Very BEST BRANDS available for immediate delivery!

FREE OFFER!

5 lbs. of good usable radio service parts with every 100 tubes ordered; a kit of assorted radio repair hardware free with every 50 tubes ordered!

TUBES and PARTS

02A	59c	2B7	.89	6AT6	.59	6CD6G	1.49	6SG7	.73	7B7	.73	12AV7	.89	1B3GT	ea. 95c	6B06GT	ea. 85c	12AT7	ea. 89c	
02AG		2C34	.60	6ASS	.30	6D6 78	1.10	6SH7	.69	7B8	.73	12AW6	.95	1K2A	ea. 89c	6B07	ea. 1.19	12AU7	ea. 65c	
1A5GT	.65	2E5	.89	6AUSGT	.89	60B6	1.15	6SH7GT	.69	7C4	1.30	12AX4	.69	6A8A	.69	6B07	ea. 1.29	12AX4	ea. 69	
1A7	.69	2K2 879	.74	6AUG	.59	6E5	.69	6S17	.69	7C5		12AX7	.69	6A06	ea. 59c	6C06G	ea. 1.49	45 Special	ea. 29	
1B3GT	.95	31F4	1.19	6AV5GT	.89	6F5GT	.59c	6S17GT	.59c	7C6	73c	12BA6	.59	6AY5GT	.89	608	ea. 89c	79L7GT	ea. 89	
1C7		3Q5GT	.69	6AV6	.59	6F6GT	.59	6SL7GT	.69	7E6	.69	12BA7	.69	6AX4	.69	6V3	ea. 1.29	715B	ea. 7.75	
1E7	29c	3S4	1.08	6AX1	.69	6F8G	1.15	6SN7GT	.69	7E7	.69	12BE6	59c	6B6G	ea. 1.49	6W6	ea. 1.29	807	ea. 1.55	
1H5GT	.59	3V4	1.40	6B4G	1.44	6G6G	.89	6H6GT	.59	7F7	.89	12BF6		6BL7	ea. 79c	7N7	ea. 69c	866A/1616	ea. 1.45	
1J6GT	.69	5T4	.69	6B5		6J5GT	.59	6SQ7GT	.59c	7F8	1.47	12BH7	.69	115	1.40S	1.07	3525	.55	75	
1L4	.69	5U4G	.59	6B6G	.79	6I6	1.04	6SR7GT	.59	7G7	.69	12C8		14C5	.98	3526G	.55	77	69c	
1L4A		5U4	.87	6B8GT	1.15	6I7G	.69	6SS7	.72	7H7	.69	12H6		14C7	.89	3526G	.55	79	78/606	
1LA6	1.19	5W4	.59	6B8GT	.79	6J8G	1.15	6I7G	.69	7I7	.69	12I5GT		14F8	1.30	3526G	.55	80	1.10	
1LC5	.69	5W4GT	.59c	6B8GT	.59	6J8G	.59	6I8	.89	7K7	1.07	12K7GT		19B6G	1.49	37	.72	83	1.15	
1LC6	1.19	5Y3GT	.45	6B8GT	.69c	6K6GT	.69	6J8G	.69	7L7	.69	12Q7GT		19T8	.89	38	.88c	84	84/674	
1LD5	.95	5Y4G	.54	6B8GT	.79	6K7GT	.69	6K8GT	.69	7M7	.69	12SA7GT		20	1.40	39/44	.88c	85	.79	
1L5	1.19	5X4G	.81c	6B8GT	.89	6K8GT	.69	6K8GT	.69	7N7	.69	12SA7GT		24A	.69	41	.72	117L7	1.40	
1LH4	1.19	5Z3	1.15	6B8GT	.59	6L6G	.69	6L6G	.69	7P7	.69	12SC7		25AC5GT	1.04	42	.69	117P7	.89	
1LN5	1.19	6A3	1.21	6B8GT	.69	6L6G	.69	6L6G	.69	7Q7	.69	12SF5GT		25B06GT	1.15	43	.72c	117P7	1.40	
1NSGT	.69	6A7	.71	6B8GT	.69	6L6G	.69	6L6G	.69	7R7	.69	12SF7		25L6GT	.59	45	.72c	117Z3	.59	
1P5GT	69c	6A8GT	.69	6B8GT	.69	6L6G	.69	6L6G	.69	7S7	1.07	12SG7		25W4GT	.69	45Z5	.69	117Z6	.69	
1Q5GT	69c	6A8A	.69	6B8GT	.69c	6L6G	1.40	6L6G	1.40	7T7	.69	12SH7GT		25Z5	1.04	46	.89c	715B	7.75	
1R5		6A8B	1.15	6B8GT	.69c	6M7GT	.69	6M7GT	.69	7V7	.69	12SJ7GT		25Z6GT	.69	47	.89c	807	1.55	
1S5		6A8C5GT	.89c	6B8GT	.89c	6P5GT	.69c	6P5GT	.69c	7X5	.69	12SK7GT		32L7GT	1.15	50A5	.89	813	10.95	
1T4	69c	6A8D	.69	6B8GT	.89c	6Q7GT	.59	6Q7GT	.59	7Y4	.72	12SK7GT		32L7GT	.69	50B5	.26	866A/1616	1.49	
1U4		6A8E	.69	6B8GT	.89c	6R7GT	.69	6R7GT	.69	7Y4	.72	12SK7GT		35A5	.59	50C5	.69c	1294		
1U5		6A8F	.69	6B8GT	.89c	6S7GT	1.15	6S7GT	1.15	7Z4	.72	12SN7GT		35A5	.59	50CG6	1.04	1299	29c	
1V		6A8G	1.40	6B8GT	.89c	6S7GT	1.15	6S7GT	1.15	7A4	.69	12SQ7GT		35B5	.59	50L6	.69	1619	.45	
1X2A		6A8H	.89	6B8GT	.89c	6S7GT	1.15	6S7GT	1.15	7A4	.69	12SQ7GT		35C5	.59	50X6	.69	1629	.29	
2A3	1.15	6A8I	1.08	6B8GT	.89c	6S7GT	1.15	6S7GT	1.15	7A4	.69	12SR7GT		35L6	.59	50Y6	.69	2050	2.00	
2A5	.79	6A8J	.69	6B8GT	.89c	6S7GT	1.15	6S7GT	1.15	7A4	.69	12SR7GT		35W4	.69	70L7	.89c	715B	1.15	
2A6	89c	6A8K	.81	6B8GT	.89c	6S7GT	1.15	6S7GT	1.15	7A4	.69	12SR7GT		35Y4	.69	70L7GT	.89c	715B	.87	
2A7		6A8L	.74	6B8GT	.89c	6S7GT	1.15	6S7GT	1.15	7A4	.69	12SR7GT		35Z3	.99c	70L7GT	.89c	VT51		
2B3		6A8M	.74	6B8GT	.89c	6S7GT	1.15	6S7GT	1.15	7A4	.69	12SR7GT		35Z4	.99c	71A	.87	VT52	29c	

TUBE KITS

BEST BRANDS AT BEST PRICES

3Q4, 1T4, 1R5, 1S5. List Value \$8.00. Tube Kit only. **\$1.98**

3S4, 1T4, 1S5, 1R5. List Value \$7.80. 4 Tube Kit. **\$1.98**

1U4, 3S4, 1S5, 1R5. List Value \$7.80. All Four Tubes for **\$1.98**

3V4, 1R5, 1S5, 1T4. List Value \$7.80. All for **\$1.98**

117Z3, 1U5, 3V4, 1R5, 1T4. AC-DC Portable Kit. All for **\$2.49**

12AT6, 12BA6, 12BE6, 35W4, 50B5. 5 Tubes for **\$2.59**

50L6GT, 35Z5GT, 12SQ7GT, 12SK7G, 12SA7G. 5 Tubes for **\$3.22**

TV PICTURE TUBES

Send us your duds COLLECT—up to 70 lbs. via Railway Express—Send dud shipments over 70 lbs. by truck. ONE FULL YEAR GUARANTEE—All Types

SIZE	PRICE	PLUS YOUR DUD	SIZE	PRICE	PLUS YOUR DUD
10-Inch	\$10.95		16-Inch	\$16.95	
12-Inch	13.95		17-Inch	17.95	
14-Inch	14.95		19-Inch	19.95	
7-Inch	15.95		20-Inch	20.95	
15-Inch	15.95		21-Inch	21.95	

TV ANTENNAS

8 Element Conical only **\$2.95**

10 Element conical rugged throughout only **\$3.95**

Double bay array, with stacking bars **\$7.75**

4 Bay array, with harness and stacking bars **\$14.95**

NEW DAVIS SUPER-VISION TV ANTENNA

Unbeatable for fringe area and DX—The only television antenna with a money-back guarantee. With the new Electronic Dipole Separators, **\$1.995** less mast

5" aluminum mast heavy gauge 1 1/4" diam. with interlocking end. Slip two sections together for a ten footer each **90c**

MISCELLANEOUS BUYS

1. F. TRANSFORMER—456 Kc. 19c

PILOT LIGHTS, Type No. 47 100 for 39c

VOLUME CONTROLS with switch, 2" shaft 1 meg, 1/2 meg, 1/4 meg. 34c

SINGLE ION TRAPS ea. 15c

OUTPUT TRANSFORMER— for 50L6 29c for 6V6 39c

UNIVERSAL OUTPUT TRANSFORMER, 12 watt 79c

CHIMNEY MOUNT for TV ant. 98c

WELLER SOLDER GUN 58.95

3 SPEED G. I. CHANGER 24.95

6 foot LINE CORD UL 10 for \$1.95

TV INTERLOCK CORDS ea. 49c

300 OHMTWINLEAD

55 Mil 1,000 ft. Only **\$10.95**

20 GAUGE, 80 MIL WEB 1000 ft. **\$16.95**

100 ft. **1.89**

TV SET SPECIALS!

"FAMOUS NAME TELEVISION SETS!"

- Automatic Gain Control
- Saw Tooth AFC
- Standard Coil Tuner—adaptable to UHF
- Transformer-operated throughout—no selenium Rectifiers.
- All the exclusive features of most expensive sets
- Meet all Standard RTMA requirements
- Finished in luxurious mahogany
- Manufacturer Licensed under RCA Patents.

17" Table Model now only **\$149.00**

20" Table Model now only **169.00**

21" Table Model now only **179.00**

Console Sets \$20.00 additional.

Limed Oak Finish **\$12.50 extra**

Outdoor TV Antenna Special!

Famous Make Folded Dipole In-line Antenna—no assembly necessary—elements snap in place with guaranteed positive lock. At this low price, we cannot mention manufacturer's name **ONLY \$4.95**

Fringe Area DOUBLE "V" TV ANTENNA KIT **\$6.95**

High Gain. Best Pictures Possible... complete with 300 ohm line, insulators, guy wire, hardware, full size antenna with double length 9 ft. mast.

RESISTOR KITS

Insulated 1/2, 1 and 2 watt assortment of most used values, I.R.C. Ohmite, Stackpole, Speer, etc. 100 for **\$2.95**

P. M. SPEAKERS

12" COAXIAL PM SPEAKERS—\$12.95 ea. High Fidelity with high pass filter attached. 20 watt; 40-17500 cps. response; 8 ohm VC. Very best quality—NATIONAL BRANDS. Individually Packed.

3"	ea. \$1.26	8"	ea. \$3.23
4"	ea. 1.36	10"	ea. 5.10
5"	ea. 1.59	12"	ea. 6.54

6" SPECIAL PRICE ea. \$1.59

21" TV CONVERSION KIT

Consisting of rectangular tube, 70 DEGREE YOKE, Beautiful Mask and FLY-BACK TRANSFORMER comp. **\$31.95**

20" TV CONVERSION KIT, as above, complete **\$28.95**

17" TV Conversion Kit, as above, complete **\$23.95**

Finest TV CHASSIS

Complete with all tubes, including 17" RECTANGULAR PICTURE TUBE and SPEAKER. **\$129.50**

Complete with all tubes, including 20" rectangular picture tube and speaker. **\$149.50**

Complete with all tubes including 21" rectangular picture tube and speaker. **\$159.50**

INCLUDES: Nationally Known

- manufacturer licensed under RCA patents
- permanent magnet 12" speaker
- all tubes aligned perfectly
- ideal for fringe areas—works better than other receivers and where others can't
- ultra-sensitive fringe area tuner
- standard 90-day guarantee on all tubes and parts
- full band reception and output
- gated AGC—finest automatic gain control
- COMPLETE... READY TO OPERATE

PREMIER T.V. RADIO SUPPLY

Division of Continental Corp.

3237 W. North Ave. • Chicago 47, Ill.

ARmitage 6-5550

NEW ADDRESS!

CUSTOMERS! We have moved to much larger quarters. FREE ball point pen imprinted with our new address is available... write for yours today!

TERMS 20% DEPOSIT with order, balance C.O.D. All shipments F.O.B. Chicago. Orders Less Than \$5.00—\$1.00 Service Charge.

ANCHOR BOOSTERS

Model ARC-101-100 **\$29.10**

Model ARC-101-75 **22.05**

Model ARC-101-100 is a two stage super high gain booster for the most difficult reception areas.

Model ARC-101-75 a single stage booster designed to give uniform response on all channels. One knob control.

NEW! **2 GREAT BOOKS**
By Milton S. Kiver
IF YOU SERVICE TV
—YOU NEED THEM!

**"TV Servicing Short-Cuts
Based on Actual Case Histories"**



shows you how to solve commonly recurring troubles

the book that really teaches fast, expert service techniques

This book describes a series of actual TV service case histories, each presenting a specific problem about a specific receiver. The symptoms of the trouble are described and then followed by a step-by-step explanation of how the service technician localized and tracked down the defect. Finally, there is a detailed discussion of how this particular trouble can be tracked down and solved in any TV set. The discussions which follow each case history are invaluable—they explain how to apply the proper time-saving servicing techniques to any TV receiver. Here, in one volume, is the successful experience of experts—to make your service work easier, quicker, more profitable. Over 100 pages, 5½ x 8½", illustrated. Pays for itself on a single service job.

ORDER TK-1. Only \$1.50

**"HOW TO UNDERSTAND AND USE
TV TEST INSTRUMENTS"**



shows you how to get the most from your test instruments

Provides basic explanations of how each test instrument operates; describes functions of each control and shows their proper adjustment to place the instrument

in operation. Covers: Vacuum Tube Voltmeters, AM Signal Generators, Sweep Signal Generators, Oscilloscopes, Video Signal Generators, Field Intensity Meters, Voltage Calibrators. Describes each in detail; explains functions; tells proper use in actual servicing; shows how to avoid improper indications. Because this book gives you a clear, complete understanding of your test instruments, you get more out of them, save time, and add to your earning power. Over 175 pages, 8½ x 11", illustrated.

ORDER TN-1. Only \$3.00

HOWARD W. SAMS & CO., INC.

Order from your Parts Jobber today, or write direct to Howard W. Sams & Co., Inc. 2203 East 46th Street, Indianapolis 5, Ind.

My (check) (money order) for \$..... enclosed. Send the following books:

- TK-1 (\$1.50) TN-1 (\$3.00)

Name.....

Address.....

City..... Zone..... State.....

controls, not all of them use the same names. Thus, "Range Frequency" of Fig. 1 is also known as "Fine Frequency," "Frequency Vernier" or just plain "Vernier." Alternate names for this and other controls are listed in Table 2. This is often a big stumbling block to the novice and it would help him considerably if the industry agreed on a standard name for each control.

Other Controls

In addition to the foregoing there are other controls (and their circuits) which broaden the application of the oscilloscope. The more important of these are listed below, together with a brief description of what they do.

1. *Phasing Controls.* This control, generally designated as "60 C Phasing" or "Horizontal Phasing," is brought into play when the oscilloscope is employed in conjunction with a sweep frequency generator. The sweep generator feeds its signal into one end of the system and the circuit response pattern is developed on the screen of an oscilloscope placed at the other end of the system.

In order that the observed response curve have a linear frequency base, it is necessary that the beam move in step with the changing frequency in the generator. Since the sweep oscillator is driven by a 60-cycle a.c. voltage, horizontal beam deflection should follow suit. To accomplish this, the horizontal input is switched away from its internal saw-tooth oscillator and a 60-cycle sine wave voltage is substituted. Ordinarily, the sweep generator will supply this voltage. However, some oscilloscopes have a special circuit for supplying their own.

Besides the a.c. voltage, some means must be available for bringing the beam in phase with the a.c. driving voltage used to sweep the frequencies back and forth. For this, a phasing network is employed. One of the elements of the network (a resistor usually) is made variable and this becomes the "Phasing" control. It is adjusted until a single response curve is visible on the scope screen.

2. *Vertical Polarity Reversing Switch.* This is usually a two-position switch marked "Normal" and "Reverse." When the switch is moved from one position to the other, the pattern on the screen is flipped over or reversed

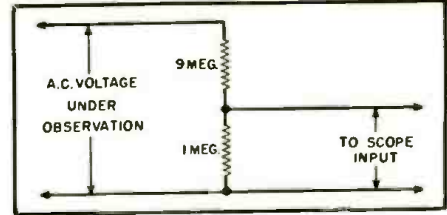

Fig. 3. Voltage divider which can be used when the applied voltage is too high.

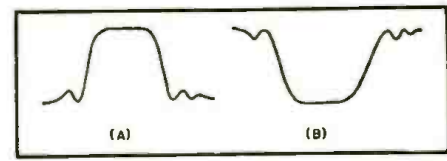

Fig. 4. Patterns for "Normal" (A) and "Reverse" (B) settings of polarity switch.

in the vertical direction. Thus, if the pattern appears as shown in Fig. 4A when the switch is in one position, it will appear as shown in Fig. 4B when the switch is turned to the other position. This is a useful device for interpreting TV video i.f. and sync or sweep waveforms, especially when the manufacturer's manual shows the pattern in one position and your scope shows it in the opposite position.

Reverse pattern on the screen is a source of confusion to many technicians. Why, for example, should the manufacturer's bulletin show the pattern pointing up when your scope has it pointing down? Does it mean that your equipment is hooked up wrong or does it indicate a defective circuit?

Actually, the answer is neither one. The polarity of the signal at various points in a television receiver is important and in general the manufacturer attempts to show the signal as it should be at each specific point. Now, this same signal, fed to your scope, may come out (at the screen) right side up or upside down, depending upon whether your scope has an even or an odd number of stages in its vertical amplifier system. Any voltage passing through an amplifier is reversed in phase by 180°. Therefore, if the signal shown in Fig. 4A is fed into the grid of an amplifier, it will appear at the plate as shown in Fig. 4B. Pass this second signal through one more stage and lo and behold, it is rightside up again.

As a general rule, two or any even number of stages will produce a sig-

Table 2. Alternate names frequently used for various oscilloscope controls. Common abbreviations, such as "Vert." for "Vertical," have been omitted from listing.

NAME OF CONTROL	ALTERNATE NAMES
Vertical Centering	Vertical Position, V Center, Y Position
Horizontal Centering	Horizontal Position, H Center, X Position
Vertical Gain	V Gain, V Vernier, Y Amplitude, Vertical Amplifier
Horizontal Gain	H Gain, H Vernier, X Amplitude, Horizontal Amplifier
Sync	Sync Amp., Sync Lock, Locking, Sync Signal, Sync Gain, Sync Control
60-Cycle Phasing	Horizontal Phasing, Phase
Horizontal Attenuator	Horizontal Sensitivity, Horizontal Input Control
Vertical Attenuator	Vertical Sensitivity, Vertical Input Control
Fine Frequency	Frequency Vernier, Vernier, Sweep Vernier, Range Frequency
Sweep Frequency	Sweep, Sweep Range Coarse Frequency, Steps, Saw-Tooth Sweep Frequency Range

Investigate this professional school— whose graduates are wanted, well paid and respected by the entire electronics industry

*An open letter to young men
of ambition from a pioneer
in the field of radio-TV education*

— by —

**E. H. RIETZKE, Founder and President of
CAPITOL RADIO ENGINEERING INSTITUTE**

IF YOU HAD TRAVELED with me on my recent trip across the United States and Canada, you would have seen with me the proud, grateful, earnest faces of CREI graduates and students. Proud that they had converted ambition into success. Grateful for what CREI had given them. Earnest in their plea to you to study for success.

Personnel Directors and Chief Engineers thanked me for personnel we had sent them—and bombarded me with requests for more.

I received the same reaction in every electronics installation, TV and radio station and factory I visited. I was proud that the professional school which I founded could point to such a fine record of accomplishment.

But I realized that our job has just begun. The growth of the electronics industry thus far is just a trickle compared to the future.

There are already 111 television stations. The FCC, by its "unfreezing" action, makes way for 2000 more stations. Over 18,000,000 TV sets are in use—that is 5,000,000 more than experts predicted there would be in 1954. There are over 100,000,000 radios in operation—in 95% of America's homes—and served by over 2500 radio stations.

Billions in electronics contracts have been awarded in the defense build-up. By 1960, it is estimated that the radio-electronics industry should do no less than \$10,000,000,000 per year, not counting military orders.

This is but a fraction of the picture of expansion.

There is already a gaping shortage of trained men to accept the thousands of openings in development, research, design, production, testing, inspection, manufacture, broadcasting, telecasting and servicing. The best jobs, the highest rewards, the posts of leadership are going to the trained men. And the better the training—the better the results.



If you are a beginner, CREI is not the school for you. There are other schools equipped to do much more for you. In a year or two, they can bring you to the point where you can profitably enroll at CREI.

If, however, you are a graduate of one of these other schools—or if you have been gainfully employed in the Radio-TV-Electronics industry for one year, or more, CREI can help change your life.

I founded CREI more than 25 years ago to provide professional level advanced training for men in the field. 98% of all our students were employed in electronics at the time they enrolled.

I can safely say that we have more contracts with leading companies for group training—than all other radio educational institutions combined. Let me mention just a few: United Air Lines,

Columbia Broadcasting System, Canadian Broadcasting Corporation, Trans-Canada Air Lines, Bendix Products Division, All-American Cables & Radio, Inc., RCA-Victor Division, the Machlett Laboratories—all have chosen CREI technical courses for group training of their own electronic personnel.

In CREI's Home Study Course you will receive authentic and complete courses, prepared by recognized experts, in a practical, easily-understood manner. You will learn under the supervision of a staff instructor. Your work will be graded by your instructor, not by machine. Return letters will indicate where you can improve. Your CREI diploma will be your key to success.

CREI's home study courses, and residence school, are accredited by the Engineers' Council for Professional Development.

The best way to find out about CREI is the way I am now going to suggest. Talk to your supervisor, to the chief engineer of your local radio or television stations, to CREI graduates, to the officials of any radio school—anywhere. I, with every member of the distinguished CREI faculty, am ready to stand on whatever answer they give you.

We have prepared a booklet called "Your Future in the New World of Electronics." In it you can find the breath-taking future of the industry, translated into *your* future. It contains an outline of the CREI curriculum that can transform your life from one of placid, plodding, ordinariness—to a full, happy, successful life of leadership in the fastest growing industry in the world.

Having expressed my pride in the past of the educational system and institution I represent, I make this pledge:

Wherever there is a man of ambition, I want to help him achieve the highest of which he is capable—in the glamorous, rewarding world of Electronics.
May I hear from you soon?



CREI resident instruction offered in Wash., D. C. VETERANS: If discharged after June 27, 1950, check last line of coupon for information about new G. I. Bill.

CAPITOL RADIO ENGINEERING INSTITUTE

Dept. 111E, 3224 16th St. N.W., Washington 10, D. C.

Send booklet "Your Future in the New World of Electronics" and course outline.

CHECK
FIELD OF
GREATEST
INTEREST

- Practical Radio Engineering Aeronautical Radio Engineering
 Broadcast Radio Engineering (AM, FM, TV)
 Practical Television Engineering
 TV, FM & Advanced AM Servicing

Name

Street

City Zone State

Check Residence School Veteran

accompany them, it will be found that the horizontal input terminals are sometimes called the "X" axis. This terminology was borrowed from mathematics where it is customary to refer to all horizontal axes as "X" axes. By the same token, the vertical input terminals are referred to as the "Y" axis. And, to complete the analogy, the intensity modulation terminal is known as the "Z" axis.

4. *Self-Measurement of Peak-to-Peak Voltages.* In servicing a television receiver, it is important not only to observe whether the wave possesses the proper shape but frequently also whether its amplitude is correct. The latter is especially critical in horizontal and vertical sweep systems. Inclusion of some means for measuring the peak-to-peak values of a wave is becoming increasingly popular in oscilloscopes. In its simplest form the manufacturer provides a terminal on the front panel which is internally connected to one of the windings of the power transformer. Usually this is the 6.3-volt winding. When this voltage is connected to the vertical input terminal, by means of a short jumper, the sine wave produced on the screen has a peak-to-peak value of 17.64 volts. This is because 6.3 is the r.m.s. value. When this is multiplied by 2.8 it becomes peak-to-peak.

For convenience, the height of the 17.64-volt wave is adjusted (by means of the vertical gain control) until it occupies one inch vertically on a ruled screen mask. Then the reference voltage is removed and the unknown voltage applied in its place to the vertical input terminal. The height of this wave is then compared to the height of the 17.64-volt wave and by means of a simple proportion, its peak-to-peak value is determined.

Reference voltage values of 1 volt, 3 volts, and 10 volts are also popular in place of 6.3 volts. Sometimes the values are given as r.m.s. and sometimes as peak-to-peak. If in doubt check the instruction manual before using.

Other oscilloscopes have more elaborate measuring systems, some using a selector switch with a series of different voltages available and some going so far as to include a voltmeter on the front panel. Generally, the more reference voltages there are, the more accurate the measurement of the unknown voltage.

When a scope does not contain provision for the self measurement of peak-to-peak voltages, there are voltage calibrators available. These are instruments providing reference voltages which are first placed on the scope screen to calibrate the instrument and then removed while the unknown voltage is exhibited on the screen. Since these units are specifically designed for this purpose, they are frequently simpler to use than the scope system.

5. *Probes.* Television receivers contain many circuits in which only r.f. signals are present. If it is desired to



NOW . . . Assemble Your Own Connectors . . . When You Want Them . . . the Way You Want Them, with ELCO'S New

VARICON Connector Kit!

From America's quality manufacturer of sockets, shields and connectors comes this sensational

new Varicon-Connector Kit, containing all parts needed (at the time needed) for almost any type connector, with any number of circuits! And . . . variations in arrangement of contacts at time of assembly makes possible the use of more than one connector, with the same number of contacts, but with different polarity! The Varicon-Connector System is entirely new, too! Identical male and female components; only 4 basic parts; high current and high voltage rating; low resistance, low capacitance! Your finished assemblies will be precision connectors of high quality, appearance, practicability and versatility! Connectors are available in general purpose black phenolic; low-loss mica phenolic, natural; alkyl, natural; or urea, in colors. Moderate price.

IF IT'S NEW . . . IF IT'S NEWS . . . IT'S FROM

At Your Jobbers
or Write Us,
Dept. RTN
and We'll Tell
You Where

ELCO SALES CO.
RADIO • TELEVISION • ELECTRONIC COMPONENTS
190 W. GLENWOOD AVE., PHILA. 40, PA.

SMASH SALE!

SUPREME TEST EQUIPMENT

MODEL 600 TUBE & SET TEST

SUPREME'S Time Tested Emission Tube Tester with all Multi-meter functions—Battery Tester (including the 07.5 volt). Sockets for all tubes (including tube pin) and a spare.

METER—7" Clear Plastic. Over 6" of calibrated scale plus mirrored arc for accurate readings.

FLEXIBLE—SUPREME'S patented Filament Return selector switch assures only one socket for each type tube.

ROLL CHART—Illuminated—double width—ample room for all tube listings. Plus one year free tube setting service.

MULTI-METER RANGES—Operate at the touch of a button.

CASE—Metal in beautiful Hammered finish with removable cover, new type leather carrying strap.

DC VOLTS—7 ranges of 0.5/10/50/250/500/1000/2500 ohms per volt. Lowest reading of .1 volts. All ranges 1000 ohms.

AC VOLTS—6 ranges of 0/10/50/250/500/1000/2500 volts. Rectifier guaranteed as any other part. Double bridge circuit affords maximum of scale linearity and rectifier protection.

DC CURRENT—7 ranges: 0-1000 microamperes 1/5/10/50/250/500/1000 milliamperes and 1/10 amperes. Lowest reading 1 microampere. All shunts wire wound.

OUTPUT VOLTS—6 ranges of 0.5/10/50/250/500/1000 volts. Ideal for receiver alignment. No ext. condenser.

OHMMETER—7 ranges of 0/200/20,000/200,000 ohms and 2/20 megohms. Center scale of low range 3.5 ohms. Lowest reading 0.1 ohms. Ideal for checking low resistance coils such as voice coils and oscillator coils.

BATTERY TESTS—Provides proper loads for most commonly used A and B portable batteries.

POWER SUPPLY—100-133 volts—50/60 cycles. Special voltages and frequencies on request.

Note: Test Leads furnished with this instrument.

Size—11" x 15" x 6" Shipping Weight—20 pounds.

Regular Net Price \$117.50. SPECIAL ONLY \$89.50

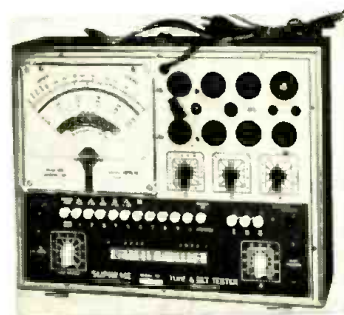
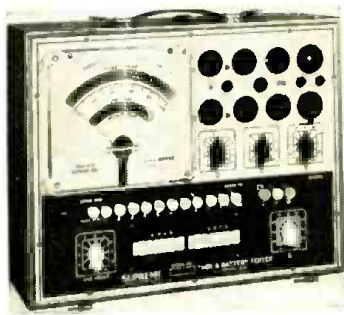

MODEL 616 TUBE & BATTERY TESTER

CHECKS AM FM TV RECEIVING TUBES AND PORTABLE RADIO BATTERIES. The Supreme Model 616 cannot be beat for EFFICIENT bench or counter tube testing. Minimized ohm-impedance by use of Supreme patented element selector system. Socket facilities for all AM, FM and TV receiving tubes. ILLUMINATED ROLL CHART with hundreds of types listed. TUBE SETTING DATA on future tubes supplied by Supreme as they come into use. Quality test readings for both tubes and batteries on "step-down" scales of beautiful BIG SEVEN INCH FULL VISION METERS. Non-breakable window. Also checks portable radio batteries UNDER PROPER LOAD. Tests batteries with rated voltages of 1.5, 4.5, 6, 4.5, and 90 volts. Hammered finished metallic case with detachable cover. Approx. dimensions 11 x 15 x 6 1/2 inches. Shipping weight 20 pounds.

Regular Net Price \$87.50. SPECIAL ONLY \$69.50

In CANADA order from CANADIAN RADIO SUPPLY, 262 Queen St., W. Toronto, Ontario.

OLYMPIC ELECTRONICS SUPPLY

DISTRIBUTORS
1440 W. OLYMPIC BLVD., LOS ANGELES 15, CALIF.

MID WINTER SALE PRICES SLASHED

T.V. TUBES—ROCK BOTTOM PRICES

In lots of 6 each No. only

68G6	89c	68G6	39c	6A05	38c
198G6	89c	6A5	69c	6CD6	\$1.05
12AX7	47c	68Q6	57c	658	49c

Tube Special—Broken Keys Electrically Perfect
12SK7 8 for \$2.12 1276 29c 4 for \$1.00
6L6 69c 4 for 2.25 12X8 49c 7 for 3.00
Tube Sale—2A7-55-27-85-31-56-57. No Mixed Ass't.
6 of Any Type \$2.25

Heavy Duty Shielded P.P. Input Trans. \$1.00
Signal Corps Trans. with Keys 49c
Bat Handle S.P.S.T. or D.P.S.T. Toggle Switch 25c
In Lots of 12, each 23c

2 Gang Var. Cond. 456 K.C. with Osc. Section. 49c
2 1/4 in. Pulley on 3/8 Shaft

2 Gang S.W. Var. Cond. 50 MMFD per Sec. Dopp. In Speed, 10-20 Meters with Tank Coil 1/4 in. Shaft 39c

Westinghouse Kurox Rectifier 0.64 Amp. 28 Volts Reg. \$11.00 ea. Special \$1.95

BRAND NEW 10" PHONO RECORDS—Ass't. Jazz—Popular, Rhythmic—All. Please Specify.
12 for \$1.79 or 24 for \$3.00

Singie Pole—10 Pos. 2 Gang Switch 29c

2 piece, 5 pole Male and Female separable Amphenol plugs. Both with Flex. shielded cables. Approx. 5 ft. long. 35c pair. 3 pr. for \$1.00

Grind your own Crystals. Pure Brazilian Quartz. Various sizes and thicknesses. 1/4 lb. pkg. \$1.00

4 Tube Drilled Chassis, 4 1/2" x 6 1/2" x 1 1/2". 29c each
5 in. 450 ohm Dynamic Speaker \$1.35

Signal Corps Phones—2 M. Ohms (8 M. Ohms Imp.) \$1.25
2 Ft. Ext. Cord (and Plug) 40c

TOBE TUBULAR ELECTROLYTICS

20-20 MFD. 150 V. 49c 30-30 MFD. 150 V. 57c
40-40 MFD. 150 V. 59c

Low-Loss Short Wave Lock Type Air Trimmer Variable Condensers
5 Pl.—20Mmfd. 14c
7 Pl.—25-30 Mmfd. 15c
8 Pl.—30-35 Mmfd. 16c
14 Pl.—56 Mmfd. 24c

1,000 OHM WIRE WOUND POTENTIOMETER \$1.50
30 HY-FILTER CHDKE SHIELDED 3 for \$1.25

PIEZO CRYSTAL HOLDERS, 12 for \$1.00—\$5.00 per C
RCA Band Switches—3 Gang, 3 pos., 3 band, 20c 6 gang, 4 pos. 4-5 band, 40c
3 Gang, 3 pos., 3 band, 20c 6 gang, 4 pos. 4-5 band, 40c
Trimmer-Padder Ass't.—all Isolantite—singles, dual: 100-100 Ass't. \$2.25

ATTENTION: Prospectors, Explorers for Hidden Treasure! Construct a U.S. Army Type of Metallic Mine Detector Amplifier. Amplifier unit only (less tubes and batteries) with cables, headphone cord, and Jack. Army wiring diagram. Type AN/PRS-1 \$1.95

MINIMUM ORDER \$3.00—NO C.O.D.
SHIPMENTS—PLEASE INCLUDE POSTAGE
NEWARK SURPLUS MATERIALS CO.
324 Plane Street Dept. JA NEWARK 1, N. J.

the TURNTABLE with the HYSTERESIS MOTOR is AGAIN AVAILABLE



Nothing Else Can Compare!

REK-O-KUT Model T-12H and T-43H

the only dual speed, 12" turntables that meet the standards for speed regulation and wow content specified by the National Association of Broadcasters... and recommended by every leading Sound Authority for use with ULTRA HIGH FIDELITY Amplifiers and Speaker Systems.

T-12H 78 and 33 1/3 RPM \$119.95
T-43H 33 1/3 and 45 RPM \$119.95

ACCESSORIES:
T-103A 45 FPM idler, with record adaptor, interchangeable with 33 1/3 RPM.
T-104A 78 FPM idler interchangeable with 45 RPM.

REK-O-KUT CO.

38-05 Queens Blvd., Long Island City, N. Y.

observe the signal waveforms in these circuits, then an r.f. probe must be employed between the scope and the receiver. The probe contains a germanium crystal or a miniature diode which detects the received signal and then applies the low-frequency modulation of the signal to the vertical input terminals of the scope for screen presentation.

A second type of probe which is finding increasing favor is the low-capacity probe. This probe permits the proper observation of waveforms in circuits that are capacity sensitive and where use of normal test leads would result in a distorted pattern on the screen.

Both probes are auxiliary pieces of equipment and are usually not included with the price listed for the oscilloscopes in Table 1. However, they do serve useful purposes and are recommended. When purchasing these units, obtain those specifically designed for your instrument. This is especially important in the case of the low-capacity probe.

Bandpass vs. Sensitivity

The function of the vertical amplifiers in an oscilloscope is to amplify applied signals in order that they may be sufficiently powerful by the time they reach the deflection plates to produce a sizable pattern on the screen. The greater the amplification available in this system, the smaller the input signal needed to produce a given vertical deflection. In other words, the oscilloscope becomes more sensitive as a measuring device.

Of importance, too, in the vertical system is its bandpass or its ability to amplify a range of frequencies. The signals whose waveshapes are portrayed on the oscilloscope screen are those found in television receivers, i.e., square waves, saw-tooth waves, and video signals, to mention the more common ones. Each of these waves contain a number of frequencies and to accurately depict their waveshapes, every frequency contained in the wave should be passed by the vertical amplifier system. For accurate television signal observation, this can mean a 4-mc. (or more) bandpass.

The objectives, then, in designing an amplifier for use in the vertical system of an oscilloscope are wide bandpass and high amplification. Unfortunately, for any given circuit, bandwidth X gain is a constant which means that if we increase the bandpass by a certain amount, we decrease its gain by the same factor. Thus, one works against the other and if we desire a wide bandpass, we must make up for the resultant gain reduction by adding more amplifier stages. This, in turn, raises the cost of the instrument.

Most manufacturers of moderately priced equipment resolve this conflict by designing the vertical system amplifiers to possess a nominal bandpass (top limit from 250,000 cycles to 1,000,000 cycles). A few manufactur-

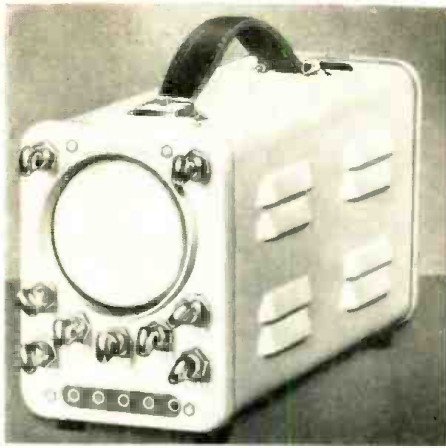

A. C. Cossor Ltd., parent company of Beam Instruments Corporation of New York, offers the Model 1039B for the American market.

ers give the instrument user a choice between high sensitivity and wide bandpass by providing a suitable switching arrangement. This, for example, is true of the Jackson Model CRO-2 oscilloscope. The "Vertical Input" control has three positions where the vertical system possesses a wide bandpass (response uniform within 10% from 20 cycles to 4.5 mc.) with a fair amount of gain and three positions where the bandpass is reduced (uniform within 10% to 100 kc.), but the gain is up. For each of these positions, attenuation ratios of 100:1, 10:1, and 1:1 are available.

In the *Triplett* oscilloscope, there is a switch at the rear by means of which the bandwidth of the vertical system can be widened from its normal value of 2 mc. to a special value of 4 mc. However, in the 4 mc. position, the system gain is cut in half.

This matter of bandpass is a source of confusion to many technicians. Just how wide should the vertical system bandpass be for suitable application to TV receiver servicing? The answer to this can be found by analyzing where (and how) the oscilloscope is employed. Broadly speaking, the scope is used in conjunction with a sweep generator to depict the response curve of a circuit or it is used for servicing to show whether or not a signal is present at a certain point in a circuit and, if so, what its shape is.

Oscilloscope use with a sweep generator requires that it be capable of depicting a waveform having a repetition frequency of 60 cycles—this being the rate at which the response pattern is swept out. Hence, the vertical system bandpass should extend down below 60 cycles, preferably 30 cycles or less. The lower this limit, the more linear the response will be at 60 cycles.

For servicing, the oscilloscope finds its greatest application in checking voltage waveforms in stages located beyond the video second detector. These include the video amplifiers, sync separator stages, and the vertical and horizontal sweep systems. In all but the video amplifier stages, the fundamental frequencies are low (either

UHF-VHF Signal Testing is QUICK, EASY with...

**THE NEW
HEAVY DUTY**

Alprodco EREC-TOWER

TEST SIGNALS UP TO 80 FT. ▶

EREC-TOWER—and only EREC-TOWER—goes up a full 80 feet. You test signal strength anywhere along the way up... determine just exactly how high the permanent antenna must be!

ERECT PERMANENT TV TOWERS ▶

Use the EREC-TOWER as a gin pole to raise permanent antenna towers. With an EREC-TOWER, for example, two men can erect a 100-foot Alprodco Tower in less than two hours. You save time, money, labor on every job!

DEMONSTRATE TV SETS ▶

EREC-TOWER helps you demonstrate sets quickly, anywhere. Here's the ideal way to show razor-sharp pictures to your fringe area prospects... right in their own homes. EREC-TOWER is a real sales closer!

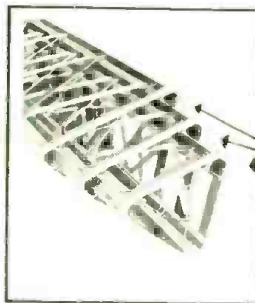

BETTER BUILT

EREC-TOWER is constructed of lifetime aircraft aluminum. Each leg and track (see opposite illustration) is extruded in one solid 24-foot length... will not buckle, crack, stick or rust.

**HEAVY EXTRUDED
ONE-PIECE ALUMINUM
TRACKS**

Dealer
Net Price
(For Tower)
\$233.50

FREE! WRITE TODAY for full information and literature on the Alprodco EREC-TOWER as well as Alprodco Aluminum TV-FM-AM Towers.

Alprodco, Inc.

302 E. MAIN ST., KEMPTON, INDIANA
MINERAL WELLS, TEXAS • DUBLIN, GEORGIA

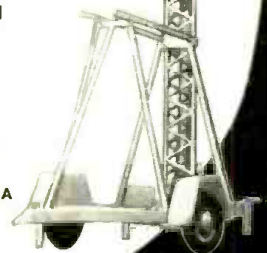

COMPARISON PROVES

the famous RAY-SCOPE antenna

gets exceptional high gain in fringe areas!

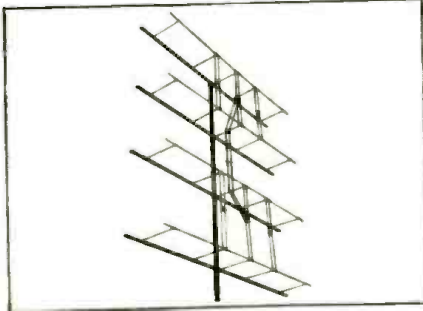

The Famous RAY-SCOPE List Price \$55.00

It's the most talked-about TV antenna, expressly designed for extreme fringe areas with exceptionally high gain on all channels. Completely reassembled, light in weight, life-long construction. For power plus, it's RAY-SCOPE!

Inquire About Our All Channel RAY-SCOPE UHF 14-83

Don't Delay — See RAY-SCOPE Today
Write For Catalog and Price List

Manufactured Only By

The DI-CO TV & PLASTIC CO., Inc.
Milford, Connecticut

Territories Available For Reps. and Jobbers

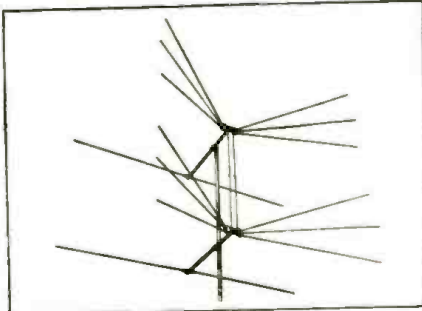

The Famous RAY-SCOPE "400" List Price \$20.50

THIS IS IT! Just flip out elements and tighten wingnuts. The ultimate in pre-assembled conicals. Acclaimed the supreme leader in its field. Highest gain in fringe areas, solid aluminum casting front and rear element brackets, seamless tubing thruout with all-weather inserts. Solid aluminum stacking bars, parts easily replaced and absolutely no loose hardware.

Look For This Trademark



SCHEMATICS—CONVERSIONS FOR SURPLUS GEAR

NEW LIST! MANY ADDITIONS!

Send stamped, self addressed envelope for List #. Add 25c for chart explaining AM nomenclature.

R. E. BOX 1220
GOODHEART BEVERLY HILLS, CAL.

We Pay Highest Cash \$\$\$\$ Prices for RADIO & AIRCRAFT ELECTRONICS EQUIPMENT

You'll be pleasantly and profitably surprised at the prices we pay for needed parts and equipment. Simply send us a description of what you have—tell us your top dollar asking price—and we'll shoot back a prompt reply! Convert that equipment to ready cash now!

Write: ALVARADIO SUPPLY CO., Division R-5
4665 Melrose Ave. Los Angeles 29, Calif.
Olympia 2155

S-38B IMPROVEMENT

By R. E. FRANKLIN, W2EUF

A number of the popular Hallicrafters S-38B receivers are known to suffer a serious volume loss and frequency shift when switched from AM to c.w. These sets use regeneration in the i.f. stage to produce beat-frequency oscillation. Reducing the feedback voltage as follows will decrease the frequency shift and the c.w. volume will be stepped up tremendously.

Originally, the regeneration was obtained from an insulated wire wrapped around pin 4 of the 12SK7 i.f. amplifier tube. By cutting off about an inch of this wire and bringing it within an eighth-inch of pin 4 a point can be found, by trial and error, that will produce the desired results. This will take some care as the hand must be withdrawn each time the wire is moved to avoid body-capacity effects. The wire should be affixed in the correct spot with a generous amount of cement.

In one conversion, one end of a piece of 300-ohm ribbon about three inches long was suspended between pin 4 and a terminal strip anchored by the lug of the i.f. can. The "wrap-around lead" was brought to this terminal and soldered. There will be capacity between the two wires of the ribbon as between the plates of a condenser, and the feedback condenser thus formed can be adjusted to a suitable value by snipping off small pieces of the 300-ohm ribbon. Do not cut the ribbon until power is removed from the set.

PAY LESS FOR TUBES

INDIVIDUALLY BOXED - FULLY TESTED - EACH TUBE GUARANTEED FOR SIX MONTHS

Type	Price	Type	Price	Type	Price	Type	Price
1B3GT	\$.63	6A55	\$.50	6J6	\$.62	12AX7	\$.61
1H5GT	.46	6AT6	.38	6K6CT	.41	12BA6	.45
1L4	.57	6AU6	.43	6L6C	.80	12BE6	.47
1L6	.58	6AV6	.38	6L6GA	.80	12BH7	.63
1N5GT	.57	6B4C	.96	6S4	.46	12SA7GT	.52
1R5	.56	6BA6	.45	6SA7GT	.52	12SK7GT	.50
1S5	.47	6BA7	.60	6SJ7CT	.47	12SL7GT	.61
1T4	.56	6BC5	.53	6SK7GT	.50	12SN7GT	.54
1T5GT	.71	6BD5GT	.89	6SL7GT	.50	12SQ7GT	.42
1X2	.67	6BE6	.47	6SN7GT	.34	198C6	1.39
3Q5GT	.65	6BF5	.60	6SQ7GT	.42	19C8	.94
3S4	.55	6BG6	1.34	6T8	.78	19T8	.79
3V4	.56	6BH6	.57	6V6GT	.46	25BQ6	.89
5U4G	.41	6BJ6	.48	6W4CT	.45	25L6GT	.48
5V4G	.73	6BK7	.85	6W6GT	.57	25Z6GT	.48
5Y3G	.34	6BL7	.83	6X4	.83	35A5	.47
5Y3GT	.30	6BQ6	.89	6X5GT	.59	35C5	.47
6AB4	.46	6BQ7	.85	6Y6G	.52	35L6GT	.47
6AC5	.54	6C4	.34	7N7	.38	35W4	.31
6AK5	.95	6CB6	.53	12AT6	.68	35Z5GT	.30
6AK6	.63	6CD6	1.85	12AT7	.38	50B5	.47
6AL5	.40	6FGT	.45	12AU7	.53	50C5	.47
6AQ5	.46	6FG6	.93	12AU7	.43	50L6	.47
6AQ6	.42	6HGT	.49	12AV6	.80	117Z3	.39
6AR5	.38	6J5GT	.40	12AV7	.40	117Z6	.68

Each tube is performance-proven. 25% deposit must accompany all orders. Balance C.O.D. All Prices F.O.B., N.Y.C. If remittance is made with order, you can deduct 25% \$1.00 handling charge for orders under \$10.00. Subject to Prior Sale.

PHILLIPS TUBE COMPANY 2610 E. 16th Street
Brooklyn 35, N. Y.

J. E. SMITH
President
National Radio
Institute
Washington, D. C.



I Will Train You at Home for Good Pay Jobs, Success in RADIO-TELEVISION



YOU LEARN SERVICING by practicing with equipment I furnish

You build valuable Multitester (at left) as part of my Servicing Course. You use it to make many tests, get practical experience, make EXTRA money fixing neighbors' radios in spare time. Many of my students earn \$5, \$10 a week extra while learning. I send you many other kits too. You build a modern Radio. You build many circuits common to Radio and Television. All equipment is yours to keep. Read about and see other equipment in my free book. Mail card below.



YOU LEARN COMMUNICATIONS by practicing with equipment I furnish

As part of my Communications Course I send you kits of parts to build the low power broadcasting transmitter shown at right and many other circuits common to Radio and Television. You use this equipment to get practical experience putting a station "on the air," performing procedures demanded of Broadcast Station operators. I train you for FCC Commercial Operator's License. Mail Card for Sample Lesson and 64-Page Book. FREE!



TELEVISION is Today's Good Job Maker

In 1951 over 15,000,000 homes had Television sets, more are being sold every day. 108 TV stations are already operating, over 1800 are now authorized and many hundreds are expected to be on the air in 1953. This means new jobs, more jobs and better pay for trained men. The time to act is NOW! Start learning Radio-Television servicing or communications. Want to get ahead? America's fast growing industry offers good pay, a bright future and security. Cut out and mail card now. J. E. Smith, President, National Radio Institute, Washington, D.C.

There are Good Jobs, Good Pay, Success in Radio-TV! SEE OTHER SIDE

CUT OUT AND MAIL THIS CARD NOW

Sample Lesson & 64-Page Book

Both FREE

This card entitles you to Actual Lesson on Servicing, shows how you learn Radio-Television at home. You'll also receive my 64-Page Book, "How to Be a Success in Radio-Television." Mail card now!

NO STAMP NEEDED! WE PAY POSTAGE

Mr. J. E. SMITH, President,
National Radio Institute, Washington 9, D.C.

Mail me Lesson and Book, "How to Be a Success in Radio-Television." (No Salesman will call. Please write plainly.)

NAME AGE

ADDRESS

CITY ZONE STATE

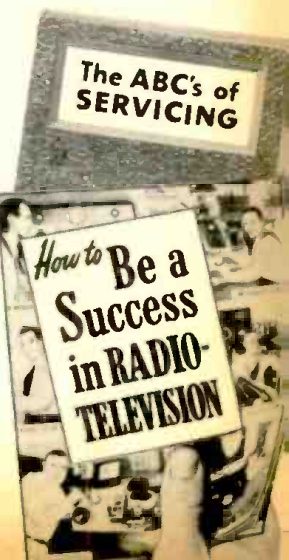

Train at Home to Jump Your Pay as a RADIO-TV Technician



J. E. Smith, President
National Radio Institute

The men whose letters are published below were not born successful. At one time they were doing exactly as you are doing now... reading my ad! But they acted. They decided they would know more... so they could earn more! They acted! Mail the card now for my 2 books FREE.

There's a Bright Future for You in America's Fast Growing Industry

Do you want good pay, a job with a bright future, security? Would you like to have a profitable business of your own? If so, find out how you can realize your ambition in the fast growing RADIO-TELEVISION industry. Even without Television, the industry is bigger than ever before. 105 million home and auto radios, 2900 Radio Broadcasting Stations, 108 TV Stations with 1800 more now authorized. Expanding use of Aviation and Police Radio, Micro-Wave Relay, Two-Way

Radio for buses, taxis, etc., are making opportunities for Servicing and Communications Technicians and FCC Licensed Operators.

You Learn by Practicing with Kits I Furnish

With both my Servicing Course and my NEW Communications Course I send you many Valuable Kits of Parts. They "bring to life" theory you learn in my illustrated texts. Mail card for my big 64-page book. It shows photos of equipment you build from kits I send.

My Training Includes Television

Both my Servicing and Communications Courses include lessons on TV principles. You get practical experience by working on circuits common to both Radio and Television. My graduates are filling jobs, making good money in both Radio and Television. Remember, the way to a successful career in Television is through experience in Radio.

Send NOW for 2 Books FREE
Mail the Postage-Free Card NOW!

What will YOU be doing one year from today... will you be on your way toward a good job of your own in a Radio and Television service shop or business? Decide now that you are going to know more and earn more! ACT NOW! Take the important first step to a career and security. Send the postage-free card now for my FREE DOUBLE OFFER. You get Actual Servicing Lesson. Also my 64-page book, "How to Be a Success in Radio-Television." Read what my graduates are doing, earning; see equipment you practice with at home. Mail card now. J. E. SMITH, President, National Radio Institute, Washington 9, D.C. Our 39th year.

NRI Training Can Lead to Jobs Like These in RADIO-TELEVISION

- | | |
|--|---|
| BROADCASTING
Chief Technician
Chief Operator
Power Monitor
Recording Operator
Remote Control Operator | GOVERNMENT RADIO
Operator in Army,
Navy, Marine Corps,
Coast Guard
Forestry Service
Dispatcher
Airways Radio Operator |
| SERVICING
Home and Auto Radios
P.A. Systems
Television Receivers
Electronic Controls
FM Radios | AVIATION RADIO
Plane Radio Operator
Transmitter Technician
Receiver Technician
Airport Transmitter Operator |
| IN RADIO PLANTS
Design Assistant
Transmitter Design Technician
Service Manager
Tester
Serviceman
Research Assistant | TELEVISION
Pick-up Operator
Voice Transmitter Operator
Television Technician
Remote Control Operator
Service and Maintenance Technician |
| SHIP AND HARBOR RADIO
Chief Operator
Assistant Operator
Radiotelephone Operator | POLICE RADIO
Transmitter Operator
Receiver Serviceman |

I TRAINED THESE MEN



Handicapped but Successful

"I am now Chief Engineer at WHAW. My left hand is off at the wrist. A man can do if he wants to." R. J. Bulley, Weston, W. Va.



\$10 a Week in Spare Time

"Before finishing, I earned as much as \$10 a week in Radio servicing. In my spare time, I recommend NRI!" S. J. Petrucci, Miami, Fla.



Control Operator, Station WEAN

"I received my license and worked on ships. Now with WEAN as control operator, NRI course is complete." R. Arnold, Rumford, R. I.



Trained Men Make Money in TV

"I am now servicing Television. Your course enabled me to repair TV receivers without any trouble." R. Currier, Fair Haven, Vt.



Has Growing Business

"Am becoming expert Teletriple as well as Radiotriple. Without your course this would be impossible." P. Brogan, Louisville, Ky.



Got First Job Thru NRI

"My first job was with KDLR. Now Chief Eng. of Radio Equipment for Police and Fire Dept." T. Norton, Hamilton, Ohio.

Find Out What RADIO-TV Offers You



SAMPLE LESSON and 64-PAGE BOOK Both FREE

Cut out and mail postage-free card today!

FIRST CLASS
Permit No. 20-R
(Sec. 34.9, P.L.&R.)
Washington, D.C.

BUSINESS REPLY CARD

No Postage Stamp Necessary If Mailed In The United States

4c POSTAGE WILL BE PAID BY
NATIONAL RADIO INSTITUTE

16th and U Sts., N.W.

Washington 9, D. C.

Make Extra Money While Learning

Keep your job while training. Many NRI students make \$5, \$10 and more a week extra fixing neighbors' Radios in spare time while learning. I start sending you special booklets that show you how to service sets the day you enroll. Multi-tester you build with parts I furnish helps discover and correct Radio troubles.



Want Your Own Business?

Many N.R.I. trained men start their own business with capital earned in spare time. Let me show you how you can be your own boss... Robert Dohmen, New Prague, Minn., (whose store is shown at right) says, "Am now tied in with two television outfits and do warranty work for dealers. Often fall back to N.R.I. textbooks for information on installing Television sets."



Mac's Service Shop

(Continued from page 60)

to meet competitive prices and for not having limitless time at their disposal for working out every last bug from a new model. You do not seem to realize that you are second-guessing all of these errors. They might prove to be a lot harder to see if you were depending upon foresight instead of hindsight.

"And this prod is for your doing all your yelling where it will do no good. If you see a mistake has been made in the design of a chassis or a record-changer, why don't you sit down and write a courteous letter—not one of the smart aleck, how-can-you-be-so-dumb type—to the manufacturer telling him what you have found and making suggestions for correcting the trouble? You may be surprised at the appreciation he will show, and you can be certain he will not repeat the mistake in future models.

"I might suggest, too, O Bumptious One, that sometimes you are guilty of trying to blame your own lack of service skill and enterprise on to the set-maker. Time after time I have seen your kind try to persuade yourself that a poorly-operating set never did work any better, that it was *made* that way; consequently, nothing could be done about it. How you can make yourself believe anyone would pay his good money for a new receiver in that condition I'll never know. If you would concentrate more on improving your own knowledge and technique instead of always being so alert to catch the manufacturer off base, you'd be a better technician for it."

"Hey, lemme see that technician-doll of yours," Barney demanded as he grabbed it from Mac's hand. "Uh huh, it's just as I thought. Did you *have* to make him with red hair?" he asked plaintively.

"You know," he went on reflectively, "I'm beginning to think there is something in this voodoo stuff after all. I could have sworn that I actually felt some of those jabs you gave this little feller."

"Imagination—and a guilty conscience—can play strange tricks," Mac commented; "but let's get away from all this hocus-pocus and talk a little sense. I ran across something yesterday I think may interest you. A fellow came in with the complaint that his radio-controlled garage door had suddenly become very erratic in its behavior. It opened and closed of its own accord while the car that had the controlling transmitter was miles away and the transmitter was shut off.

"I went over and checked the thing over carefully, but I couldn't find a thing wrong with it; a good healthy signal from the transmitter was required to trip the pilot relay; there were no gassy tubes to cause trouble; running the line voltage up and down made no difference. First thought of

mine was that possibly a harmonic of a ham transmitter was getting into the receiver and making the relay trip, for I have read of that; but since Ten went dead none of the local gang are working the high-frequency bands; so I decided to look for something else. I asked the man if any new electronic equipment had been installed in the neighborhood lately, and after I explained what 'electronic equipment' was, he said all he could think of was a new TV set in the house across the street that had been in for a couple of weeks.

"Playing a hunch, I went over and asked the folks if they would mind turning on their TV receiver for a few minutes. As I stood in front of the receiver I could see the closed garage doors; and when I turned the channel selector to Channel 10, the doors opened up. I tried it two or three times, and every time the set was tuned to Channel 10, the doors worked. With the i.f. used in that set, the oscillator was on about 219 megacycles when the receiver was tuned to Channel 10, and that is squarely inside the 210-250 megacycle band in which the door-opener works. Fortunately, provision had been made for using any one of six different frequencies in the garage-door setup; so I just moved the transmitter to a different frequency and peaked up the receiver on that. When this was done the TV set could be switched to any channel without affecting the doors."

"That is one for the book," Barney said; "and it just goes to show you what a hefty signal is radiated from the oscillator of some of the TV receivers. No wonder we hams get the blame for a lot of blanking out and herringbone patterns that are caused by a neighbor's TV set tuned to a lower channel!"

-30-

Within the Industry

(Continued from page 26)

Transicil Corp. has appointed **DWIGHT W. BLOSER** to the post of chief engineer in the manufacture of control motors, induction generators, gear trains, and servo amplifiers.

* * *

DR. JOHN RUZE has been appointed director of research of *The Gabriel Laboratories, Division of The Gabriel Company.*



He joins the company from the Air Force Cambridge Research Laboratories, where he was assistant chief of the antenna laboratory. During the war he headed the antenna design section at the Signal Corps Engineering Laboratories.

A native of New York, Dr. Ruze received his doctorate from the Massachusetts Institute of Technology after completing his work for his MS degree at Columbia.

-30-

New Portable Battery-Operated Spring-Motor Tape Recorder



The Magnemite*

For all field recording without AC power! Smaller and lighter than a portable typewriter, the Magnemite* actually makes field recordings that can be played on any studio console equipment. Completely self-powered, the Magnemite* does away with bulky and cumbersome generators, storage batteries and rechargers.

Just check these unusual features:

- Noiseless and vibrationless governor-controlled spring-motor assures constant tape speed.
- 100 operating hours per set of inexpensive flashlight-type dry cell batteries.
- Earphone monitoring while recording, and earphone playback for immediate quality check.
- Operates in any position, and is unaffected by movement or vibration during operation.
- Warning indicator tells when to rewind, and shows when amplifier is on.
- Broadcast models weigh 15 pounds. Slow-speed models weigh only 10 pounds.
- Requires no more desk space than a letter-head, measuring only 11 x 8½ x 5½ inches.

There's a choice of 5 different models for any recording need. High fidelity units, meeting primary and secondary NARTB standards, which record and play back frequencies up to 15,000 cycles, are available for broadcast stations, critical music lovers, and scientific research. For investigation, missionaries, reporters, and general dictation while traveling, there are units which play up to 2 hours per reel of tape.

Write today for complete descriptive literature and direct factory prices.

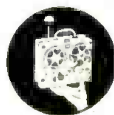

**AMPLIFIER CORP.
of AMERICA**

398 Broadway, N. Y. 13, N. Y.

*Trade Mark Reg.

McGEE'S \$250,000 PUBLIC ADDRESS SYSTEM SALE!

FEATURING 3-SPEED PHONO AND TWIN 12" ALNICO V SPEAKERS
IMMEDIATE SHIPMENT AT UP TO 60% SAVINGS!

5 Trailer loads—over \$250,000 worth of underwriters lab. approved public address systems on sale at McGee for a fraction of the original price. Purchased from one of the largest mail order companies in the United States. These amplifiers are made of the finest material to U. L. standards for 105 to 125 volt 60 cycle operation. Compare their weight with other amps and you can see for yourself. Follow our ordering instructions for immediate delivery.

HOW TO ORDER: Send full remittance and you save the added C.O.D. collection fee, or if you wish include a 25% deposit and the shipment will be made C.O.D. for the balance. All prices F.O.B. Kansas City, Missouri. Specify whether you wish shipment to be made by Express or Truck. Amplifiers are not available.



28 WATT \$150⁰⁰ LIST PORTABLE P. A. ON SALE \$69⁹⁵

3-SPEED PHONO TOP—TWO 12-INCH SPEAKERS
7-TUBES PUSH PULL 6L6'S HEAVY LEATHERETTE
COVERED PLYWOOD PORTABLE CASES
CRYSTAL MIKE \$8.95 EXTRA

STOCK NO. AP-28X. Portable 28 watt public address system. You get a 7 tube heavy duty push pull 6L6 amplifier with inputs for 2 mikes, either crystal or dynamic with separate mixing volume controls. One phono input. Fully variable tone control with high fidelity, wide range frequency response. The heavy duty output transformer has taps for 4, 8, 16, 125, 250 and 500 ohm speaker connections. Two heavy duty 12 inch alnico V P.M. speakers, each with 25 feet of speaker cable. Each speaker is mounted in separate carrying case. Each case has a snap out back and is large enough to give good speaker baffling. Each case is 21 x 16 x 13 inches. One is used to carry the amplifier. A 3 speed phono motor and pick up is mounted in the top of the amplifier to play 33 1/3, 45 and 78 rpm records. This portable P. A. system will put out 20 watts all day long and 28 to 30 watts peak audio. McGee offers you this \$150.00 list portable P. A. system at a terrific saving.

STOCK NO. AP-28X complete portable PA system with 3 speed phono and speakers as pictured (less mike) ship. wt. 71 lbs. \$69.95.

Electro Voice model D10 \$28.50 list crystal mike with 20 feet of cable and desk stand \$8.95 extra.

Floor type mike stand instead of desk stand \$4.95 extra.

(SEE OFFERING TO THE RIGHT FOR WALL SPEAKERS INSTEAD OF THE PORTABLE SPEAKERS.)

28-WATT AMPLIFIER WITH 12-INCH WALL SPEAKERS

The 28 watt amplifier shown to the left is also offered with-out the portable speakers. In their place we will ship two Seeburg walnut wall baffles with 12 inch heavy duty 12 inch alnico V magnet PM Speakers and 500 ohm line net speaker trans. Stock No. SS-28H 28 watt amplifier with 3 speed phono top with two 12 inch wall speakers. \$69.95. Extra 12 inch wall speakers \$11.95. Model 910 Electro Voice mike \$8.95 extra. Floor stand \$4.95 extra.



50 WATT \$250⁰⁰ LIST PORTABLE P. A. ON SALE \$99⁹⁵

3-SPEED PHONO TOP—TWO 12-INCH SPEAKERS
10 Tubes — 4 6L6's
Heavy Plywood Tan Leatherette Covered Cases

STOCK NO. AP-60X. Portable 50 watt public address system. You get a 10 tube amp with (4-6L6) push pull parallel 6L6 output tubes. Inputs for two mikes either crystal or dynamic, with separate mixing type volume controls. One phono input. Twin tone controls one for bass the other for treble high fidelity wide range frequency response. The heavy duty output trans. has taps for 4, 8, 16, 125, 250 and 500 ohm speaker connections. Two super heavy duty 12 inch 20 oz. alnico V magnet PM speakers with 25 foot cables and plugs. Each speaker is mounted in large separate cases, one is used to carry the amp. Each case is 21 x 21 x 13 inches with removable snap on back. Twice the ordinary size to give proper speaker baffling. This is the most powerful portable P. A. system we have ever offered. Most 4-6L6 amps of this size and weight are rated 60 watts. This amp will put out 40 watts all day long and 50 to 100 watts with ease. Equipped with a 3 speed phono motor and pick up to play all records. 33 1/3, 45, 78 rpm. A \$250.00 list value. Ship. wt. 100 lbs.

Stock No. AP-60X portable PA system as pictured less mike. Sale price \$99.95. Reg. \$45.00 list Electro voice model 610 dynamic mike with 20 feet of cable and desk stand \$11.95 extra.

If floor stand is desired instead of the desk stand add \$4.95.

(SEE OFFERING TO THE RIGHT FOR WALL SPEAKERS INSTEAD OF THE PORTABLE SPEAKERS.)

DYNAMIC MIKE \$11.95 EXTRA

50-WATT AMPLIFIER WITH 12-INCH WALL SPEAKERS

The 50 watt amplifier shown to the left is also offered with-out the portable speakers. In the place we will ship two Seeburg walnut wall baffles with 12 inch two super heavy duty 12 inch alnico V pm speakers with 500 ohm line trans.

STOCK NO. SS-60X 50 watt amplifier with 3 speed phono and 2 12 inch wall speakers. \$99.95. Electrovoice 610 dynamic mike \$11.95 extra. Floor stand instead of desk stand \$4.95 extra. Extra 12 inch speakers and wall baffles \$14.95.

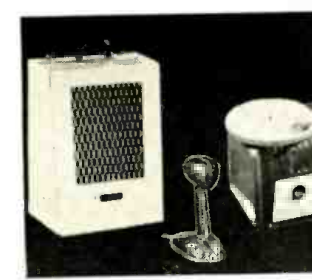

10 WATT \$90⁰⁰ LIST PORTABLE P. A. ON SALE \$42⁹⁵

STOCK NO. AP-11X. A 5 tube 10 watt (14 watts peak) push pull 7C5 U. L. approved amplifier with wide range frequency response. Inputs for one mike and one phono. Separate mixing volume controls. Fully variable tone control. Heavy plywood leatherette covered case is equipped with a heavy duty 10 inch Alnico V magnet PM speaker. The amp fits inside the speaker case. Case size 21 x 16 x 13 inches has removable snap on back. (note, this portable system has only one speaker whereas the 28 and 50 watt models shown above have two). The top of the amplifier is equipped with a 3-speed phono motor and pick up for all records. 33 1/3, 45, 78 rpm—this portable P. A. system has a list value of \$90.00. Offered by McGee at a terrific saving.

STOCK NO. AP-11X. 10 watt portable PA system with 3-speed phono. Ship wt. 41 lbs. Sale price as pictured less mike \$42.95. Crystal mike with non removable desk stand \$3.95 extra.

3-Speed Phono Top—Heavy Plywood, Tan Leatherette Case
10" Alnico PM Speaker—Crystal Mike
\$3.95 Extra

The 10 watt portable PA system shown on the left is offered less the phono top. Specify stock No. AP-11NO. Sale price \$34.95 less mike. Crystal mike with non removable desk stand \$3.95 extra.

McGEE'S \$62.50 LIST 15" COAXIAL SPEAKER, \$21.95

21 OZ. ALNICO V MAGNET—5" TWEETER



This is the finest 15" coaxial PM speaker value that we have ever offered. New 1952 production of a famous manufacturer of fine speakers. The 15" speaker has a 2 1/2 oz. Alnico V magnet, equal tweeter and woofer in one piece construction. Will reproduce low frequencies down to 20 cps. The 5" tweeter is coaxially suspended and has a ridged cone to reproduce only the high frequencies. It will respond up to 17,500 cps. The high pass filter is concealed under the pot cover, leaving only two wires to connect both the tweeter and woofer to any 8 ohm output transformer of a radio, or high fidelity music lover's amplifier. Stock No. P-15-CF. Shipping weight 13 lbs. Net price \$21.95.

12" COAXIAL SPEAKER, \$12.95



McGee offers the new 1952 model 12" coaxial PM speaker. Quality you would put in your finest sets if you were a manufacturer. 12" woofer has 6.8 oz. Alnico V magnet. Tweeter is coaxially suspended and has a metal diaphragm. High pass filter is under the pot cover. Only two wires to connect to your radio or audio amplifier. 8 ohm with 18 watt peak and 10 w a 11 average. Shipping weight 7 lbs. Stock No. CU-14Y. Sale price \$12.95 each; 2 for \$25.00.

12" JENSEN PM, \$15.95

Another McGee Scoop! Jensen Concert 12" 13 1/2 oz. Alnico V magnet PM speaker. 8 ohm voice coil. Will take 25 watt audio. You save dollars on this speaker. Just 100 to sell. Shipping weight 13 lbs. Stock No. P-12H. Sale price \$15.95; 2 for \$30.00.

G.I. 3-SPEED CHANGER WITH G.E. \$22⁹⁵

Another tremendous McGee Scoop! Brand new General Instrument variable reluctance cartridge with turn-about stylus. Plays all 3.3-speed automatic record changers. Complete with RPX-950 G.E. speeds automatically. 7", 10" or 12" records. Has reject button. Repeats last record. Base \$22.95. Shipping weight 14 lbs. Stock No. 700-GE. Scoop price, \$22.95.



G.I. 3-speed changer same as above, but with Webster flip-over twin needle cartridge. Stock No. GI-700. Sale price, \$21.95 each.

ESPEY 12-TUBE FM-AM CHASSIS, \$59.95

- ★ BUILT-IN PRE-AMP FOR G.E. VARIABLE RELUCTANCE PICK-UP
- ★ WIDE RANGE AUDIO
- ★ WHY NOT ORDER WITH A COAXIAL SPEAKER AND A RECORD CHANGER? SEE OUR SPECIAL OFFERING

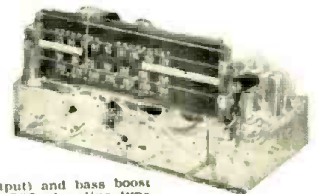

McGee's new 1952 model 12-tube FM-AM chassis. Latest design with 12 phono inputs for all types of record players, crystal or G.E. variable reluctance. Receives standard broadcast 550 to 1700 kc and FM 88 to 108 mc. Wide range audio response (push-pull 6V6 output) and bass boost. Loop antenna for broadcast and 300 ohm line type FM antenna may be obtained in cabinet. Attractive lighted slide rule dial. Chassis size, 13 1/2" x 7" high and 9" deep. Complete with tubes: 6BE6, 6BA6, 12AT7, 6BH7, 6AL5, 6SQ7, 6SQ7, 12AT7, 2-6V6GT and 5Y3GT rectifier. Shipping weight 20 lbs. Stock No. 7C-X Espey 12-tube 12" or 15" coaxial speakers. Sale price, \$59.95, less speaker. Output matches voice coil of our 12" or 15" coaxial speakers.

ESPEY DEAL (1), \$99.95

Espey 7-C chassis complete with 12" coaxial PM speaker CU-14Y and the Espey 3-speed changer equipped with a G.E. variable reluctance turn-about cartridge. Our best home music system. Extra cost = 2. Sale price \$118.95. With 15" coaxial PM speaker P15-CF instead of CU-14Y. \$10.00 extra.

ESPEY DEAL (2), \$118.95

Espey 7-C chassis complete with 12" coaxial PM speaker CU-14Y and the Espey 3-speed changer equipped with a G.E. variable reluctance turn-about cartridge. Our best home music system. Extra cost = 2. Sale price \$118.95. With 15" coaxial PM speaker P15-CF instead of CU-14Y. \$10.00 extra.

ESPEY DEAL (3) \$138.95

Espey 7-C chassis complete with THREE 12" coaxial PM speakers CU-14Y (these three 12" coaxial speakers give a cone area equal to an 18" speaker) and a Garrard 3-speed changer with G.E. variable reluctance turn-about cartridge. Espey Deal #3. Sale price \$138.95.

McGEE RADIO COMPANY

Prices F.O.B. K.C. Send 25% Deposit with Order. Balance Sent C.O.D. With Parcel Post Orders, Include Postage

TELEPHONE VICTOR 9045. WRITE FOR FLYER
1422 GRAND AVE., KANSAS CITY, MISSOURI

RADIO & TELEVISION NEWS

STANDARD BRANDS **TUBES** INDIVIDUALLY BOXED
 STANDARD WARRANTY **New Low Prices** BRAND NEW!!

024	.54	5Y3G	.39	6BA6	.54	6F6GT	.54	6W4GT	.54	12SQ7GTS	.63
1B3GT	.87	6AB4	.61	6BA7	.76	6H6	.57	6W6GT	.65	19BG6G	1.75
1L4	.65	6AC7	.98	6BC5	.65	6J5GT	.54	6X4	.49	19T8	.87
1R5	.65	6AG5	.64	6BE6	.57	6J6	.76	6X5GT	.43	25AV5GT	1.05
154	.76	6AG7	1.05	6BF5	.69	6K6GT	.54	12AT6	.47	25BQ6GT	1.08
155	.64	6AH6	1.05	6BG6G	1.86	6L6GA	1.05	12AT7	.76	25L6GT	.54
174	.64	6AK5	.94	6BH6	.72	6SA7GT	.61	12AU6	.54	25Z6GT	.49
1U4	.69	6AL5	.54	6BJ6	.61	6SC7	.76	12AU7	.65	35B5	.61
1U5	.61	6AQ5	.54	6BL7	.98	6SF5	.58	12AV7	.88	35C5	.61
1X2A	.79	6AQ6	.49	6BN6	.72	6SH7	.65	12BA6	.54	35L6GT	.61
3Q4	.75	6AR5	.54	6BQ6	1.08	6SJ7	.54	12BE6	.58	35W4	.41
3Q5GT	.72	6AS5	.62	6BQ7	1.08	6SL7GT	.65	12BH7	.82	35Z5GT	.39
354	.65	6AT6	.46	6C4	.49	6SN7GT	.73	12SA7GT	.62	50B5	.61
3V4	.65	6AU6	.54	6C5	.57	6SQ7GT	.49	12S7	.61	50C5	.61
5T4	1.31	6AV5GT	1.09	6CB6	.65	6SR7	.49	12SH7	.49	50L6GT	.59
5U4G	.54	6AV6	.46	6CD6G	1.82	6T8	.87	12SK7GT	.63	117Z3	.54
5V4G	.98	6B4G	.98	6E5	.76	6V6GT	.57	12SN7GT	.73		

Many other types equally low priced—include all your tube needs with your order.
 One of the largest stocks in the country!
 Min. Order \$25.00. Terms: 25% with order, balance C.O.D.
 All prices subject to change without notice, F.O.B. New York City. Mail order division.

Television Materials Corp.
 125 Cedar St., New York 6, N. Y. • COrtlandt 7-4307

RADIO Surplus Buys



CRYSTALS
 in FT 241-A Holders—1/2" Pin S.P.C. Marked in 5th OR 72nd Harmonic MC Freq. Listed below by fundamental frequency with fractions omitted.
 500 KC Crystals... **\$1.95**
 1000 KC Crystals... **\$3.95**

370	407	444	476	509
372	408	445	477	511
374	409	446	479	512
375	411	447	480	513
376	412	448	481	514
377	413	450	483	515
379	414	451	484	516
380	415	452	485	518
381	416	453	486	519
383	418	454	487	520
384	419	455	488	522
385	420	456	490	523
386	422	457	491	525
387	423	458	492	526
388	424	459	493	527
390	425	461	494	529
391	426	462	495	530
392	427	463	496	531
393	429	464	497	533
394	430	465	498	534
395	431	466	501	536
396	433	468	502	537
397	434	469	503	538
398	435	470	504	540
400	436	472	505	
401	437	473	506	
402	438	474	507	
403	440	475	508	
404	441			
405	442			
406	443			

\$1.00 Each
 10 for 58.00, Postpaid

FOLLOWING CRYSTALS AVAILABLE IN FT 243 HOLDERS 1/2" PIN SPACING

3500	7150	8075
3590	7350	8200
6075	8006.7	
6140	8025	
6150		
7075		

\$1.00 EACH
 11 for \$10.00 Postpaid

PLEASE ENCLOSE FULL AMOUNT WITH ORDER
 QUANTITIES AVAILABLE
 WRITE FOR YOUR REQUIREMENTS

C & H SALES CO.

Box 356-JT, East Pasadena Sta. • Pasadena 8, Calif.

ARKAY
 world's finest radio kits
 Write for free Brochure
 RADIO KITS, INC., 120 Cedar St., N. Y. 6

THE AUDIO PERFORMANCE OF

New
BROOK
 ALL TRIODE HIGH QUALITY
AUDIO AMPLIFIERS
 IS BEYOND DESCRIPTION

Let your Ears Pass Judgment

- Nine distinct positions for record playback provide complete bass and treble equalization for best-known recordings.
- Bass effective to 15 cycles results in improved transient response that makes all bass tones sound more natural.

Write for complete technical data, and be sure to listen to the new BROOK at your local dealer's Sound Department.

BROOK ELECTRONICS, INC.
 34 DeHART PLACE, ELIZABETH 2, N. J.
 Dept. RA-3

\$20.00 Amplifier
 (Continued from page 45)

The critical point here is that excessive feedback cannot be used, due to the phase shift of the circuits and the transformer, dependent on the instantaneous frequency. The attenuating resistance in the loop has been chosen to develop optimum feedback within the limits of the transformer.

Power was taken from an existing supply, but could as easily have been drawn from a radio or other source. Power supplies are all similar, and any discussion here would be redundant. All that is needed is 350-400 volts at 110-120 ma. The entire circuit is stable, as regards frequency response, and will operate as well with 350 volts as 400, with hardly noticeable loss of power under normal demands.

The cost of all the parts in this amplifier is \$20.00 or less.³ This sum can be flexible since almost endless variation is possible in the actual construction, limited only by the needs and ingenuity of the constructor.

Preamplifier

Because six different preamplifiers tried in the past year have been unsatisfactory, the circuit shown in Fig. 6 was built for use with the amplifier. The preamplifier is quite simple, and without complications. Immediately apparent is the absence of tone controls. Distortion created by tone controls is apparent to most listeners only when all tone controls are bypassed, and the sound is heard through a familiar system. The circuit is designed to develop sufficient voltage to drive the amplifier to peak undistorted power when used with a G-E RPX-040, or similar type, variable reluctance cartridge.

REFERENCES

1. Tele-Tech, January 1952, pages 90-91.
2. Audio Engineering: "An Ultra Linear Amplifier," November, 1951.
3. Allied Radio Corporation: Catalogue No. 127.

Fig. 6. Diagram of preamplifier designed to be used with the author's amplifier unit.

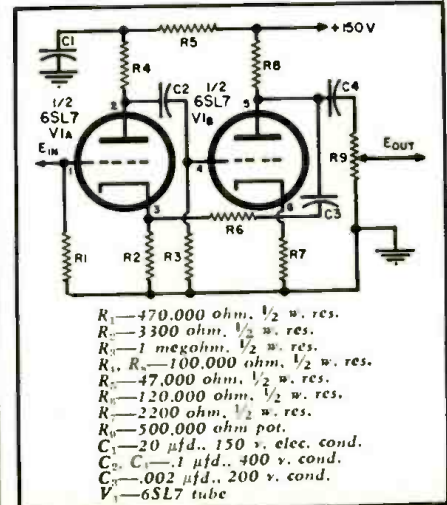

It's New!

It's Better!

Here's Proof!

Now, we have finally found the answer in your V8 antenna. Servicemen tell us its the best antenna we have ever had. It really does the job because it pulls in stations we could not get before.

**Here's How
the new RADIART
TELEVISION
V*8 ANTENNA
Solved Mr. Hartong's
Fringe Area Headaches**



**SEE FOR YOURSELF
Try One On Your
Toughest Location**



THE RADIART CORPORATION CLEVELAND 13, OHIO

VIBRATORS • AUTO AERIALS • TV ANTENNAS • ROTORS • POWER SUPPLIES

January, 1953

Burroughs
 TELEPHONE 3-0273
 711 SECOND STREET, N.W. CANTON 3, OHIO
 DISTRIBUTORS OF ELECTRONIC EQUIPMENT
 WHOLESALE ONLY

Radio, inc.

October 7, 1952

Mr. William Schoneberger
 Jobber Sales Manager
 Radiart Corporation
 3455 Vega Avenue
 Cleveland, Ohio

Dear Bill,

Just a word to let you know how we feel about your new V8 antenna.

As you know, our reception problem down here is difficult because of the fringe area position. Believe me, when I tell you almost everything that has come along has been tried.

Now, we have finally found the answer in your V8 antenna. Servicemen tell us its the best antenna we have ever had. It really does the job because it pulls in stations we could not get before.

Attached is another reorder, please keep them coming.

Sincerely yours,
 BURROUGHS RADIO INC.
D. R. Hartong
 D. R. Hartong

drh/iw

TV PROBLEMS? GRAYBURNE gives you EFFECTIVE answers!



TV-IF SIGNAL BOOSTER

An added stage of TV-IF wired up in Adaptor form. Produces excellent results in near-fringe areas and where a modest gain is required.

- Overcomes roof antenna restrictions
- Amplifies signal over 20% on all channels
- Eliminates or minimizes "snow"
- No switches or external connections
- Simple, permanent, easy installation inside cabinet

Write for free Technical Bulletin "Plug-In TV Booster" by Jack Grand. Model TSB-1 List \$995, plus extra tube required.

CLEAR-PIX TV INTERFERENCE FILTERS

4 Popular, Fast-Selling Models—reject 4 most common interference causes.

Incorporate scientifically designed and proved circuits. Have high rejection efficiency. Extremely simple to install—less than one minute.

Model #	Interference Rejected
CPF	FM
CPD	Diathermy
CPI	Ignition
CPH	Amateur (21 mc)

Low Cost: List \$198 each.



DUAL TUNABLE TV INTERFERENCE FILTERS

for Professional Installations and where Interference is intense.

Precision-engineered. Incorporate a dual set of coils and condensers center-tapped to ground for greater efficiency. Very easy to install and balance.

Model #	Interference Rejected
SW-10	10 meter band
SW-20	20 meter band
DT	Diathermy
FM	FM

List \$275 each

BE PREPARED! Keep 1 of each type of Filter in your Tool Kit at all times!

For complete Grayburne Catalog and name of your nearest distributor, write NOW to Dept. Z

GRAYBURNE

Grayburne means Quality Electronic Components

GRAYBURNE CORPORATION
103 Lafayette Street, New York 13, N. Y.

MANUFACTURERS' LITERATURE

Readers are asked to write directly to the manufacturer for the literature. By mentioning RADIO & TELEVISION NEWS, the issue and page, and enclosing the proper amount, when indicated, delay will be prevented.

UTC TRANSFORMERS

United Transformer Company, 150 Varick Street, New York 13, New York, has released a new catalogue which lists over 600 stock items covering the entire scope of electronic transformer applications.

The new publication is fully indexed, giving complete technical descriptions of all items. In addition, a center insert gives circuit details for high-fidelity amplifier equipment.

Transformers for high-fidelity systems, hermetically sealed units for military applications, special transformers for hams, and a replacement line are covered along with listings of high "Q" filter coils and complete audio filters.

CRYSTAL CATALOGUE

James Knights Company of Sandwich, Illinois, has issued a completely new catalogue covering its line of stabilized quartz crystals.

The catalogue lists 45 different crystals for use in communications equipment, laboratory instruments, medical and industrial equipment, etc.

Development engineers and others will find the new catalogue of interest. Copies may be obtained by writing the company direct.

SOUND SYSTEMS

Mark Simpson Manufacturing Co., Inc., 32-28 49th Street, Long Island City 3, New York, has issued its new general catalogue of 1952, revising its catalogue No. 50.

A complete line of school and institutional sound systems using control amplifiers with microphone, radio, and phonograph inputs for up to 40 locations is only one of the many groups of modern equipment featured.

Other items listed include high-power amplifiers, high-fidelity amplifiers, transcription equipment, mobile, and preamplification equipment.

ALLIED'S 1953 CATALOGUE

Allied Radio Corporation, 833 W. Jackson Boulevard, Chicago 7, Illinois, has released its 1953 general catalogue which contains 236 pages—the largest catalogue in the company's history.

Among the 18,000 items listed in the new publication are sound systems, television chassis, boosters, rotators and u.h.f. converters, table model and portable radio sets, professional and home recording equipment, public address amplifiers and complete systems, amateur receivers, ham transmitters and other gear, industrial v.h.f. radio and radiotelephone

equipment, as well as tools, books, hardware, kits, and other supplies.

The high-fidelity section has been expanded to include many units for custom installation: amplifiers, tuners, changers, speakers, preamps, and cabinets.

Copies of the new catalogue No. 131 are available on request to the company.

SOUND EQUIPMENT

A new eight-page, two-color catalogue illustrating and describing the fifteen 1953 models of *Califone* phonographs, transcription players, and sound systems has just been released by *Califone Corporation*, 1041 North Sycamore Avenue, Hollywood 38, California.

Accompanying the catalogue is a combined specification and price sheet for easy selection of equipment to fit the customer's requirements.

Copies of the new publication are available from the company direct.

ANNIVERSARY CATALOGUE

Burstein-Applebee Co., 1012-14 McGee Street, Kansas City, Missouri, is currently distributing copies of its 25th Anniversary catalogue, No. 531.

This 148-page catalogue lists thousands of parts and equipment items for dealers, technicians, schools, broadcasters, public utilities, experimenters, factories, engineers, laboratories, and hams.

A comprehensive index has been included to facilitate locating the part or unit desired.

Copies of the new catalogue are available without charge on request.

TRADE-IN GUIDE

Publication of the first television set trade-in guide, the "1953 NARDA TV Blue Book," has been announced by the *National Appliance Guide Company*, 2132 Fordem Avenue, Madison 1, Wisconsin.

The manual provides authentic, detailed, up-to-the-minute information on all popular TV sets of over 30 leading manufacturers and covers models produced from 1947 through 1952. The annual guide tells the dealer how to evaluate trade-ins, how to service them, and how to resell them to his and his customer's satisfaction.

Details on how copies of this manual can be obtained will be supplied by the company on request.

RADIO SHACK CATALOGUE

Copies of *Radio Shack Corporation's* 30th Anniversary Catalogue are now

New RADIO COURSE only \$2.50



MADE MONEY FIRST WEEK

"You should get more money for your Course. The first week I studied it, I made \$10.00 repairing sets. I built my own test outfit from details given in this course. I have repaired 100 radios to date."

Signed: *Robert C. Hammel*,
120 W. 13th, Davenport, Iowa.



COMPLETED IN 8 WEEKS

"I am very satisfied with the course. When I was at the twelfth lesson I started repairing radios. It took me two months to master your course." From a letter written by *Roger Langlois*, 1679 Poupart St., Montreal, Canada.



MODERN, UP-TO-DATE

"Your course is modern and up-to-date. There is not one page in the whole course which anyone can afford to miss. Your course started me on the road to a well paid job and has repaid me many times." *Charles Alsopach*, 433 Elm St., Reading, Pa.

AMAZING BARGAIN OFFER

Here is a practical home-study course that will teach you how to repair all radio sets faster and better. These newly reprinted 22 lessons cover all topics just like other correspondence courses selling for over \$150.00. Our amazing offer permits you to obtain the course complete for only \$2.50, nothing else to pay. Easy-to-follow, well illustrated sections on test equipment, circuit tracing, alignment, F.M., use of oscilloscope, amplifiers, and every other topic needed to be an expert in radio repairing. Trouble-shooting hints, circuits, short cuts, service suggestions, new developments. Send coupon today, and use the complete course at our risk. Satisfaction guaranteed. All 22 lessons, in large manual form, + self-testing questions, **\$2.50** complete, your cost only.....

INTRODUCTION TO TELEVISION

These practical lessons making up this course-book are easy to follow and apply to actual radio jobs. Use this training to get ahead in radio and as an introduction to television. Hundreds of radio facts that puzzled you will be quickly cleared up. You will find yourself doing radio repairs in minutes instead of hours — quickly finding faults or making needed adjustments. Every new radio development of importance and thousands of time-saving radio facts are packed into this complete course-manual. For example, there is a large lesson on servicing F.M. sets and another full lesson on audio amplifiers. Use coupon below to order Course for 10-day examination in your own home. Look over the material, read a few lessons, apply some of the hints. Then decide to keep the lessons at the bargain price of \$2.50 (full price), or return the material and get a cash refund. (Offer may be withdrawn at any time.)



Supreme Radio & TV Manuals

Your complete source of all needed RADIO and TV diagrams and service data. Most amazing values. Still sold at pre-Korean prices. Only \$2 for most volumes. Every Radio manual contains large schematics, all needed alignment facts, parts lists, voltage values, trimmers, dial stringing, and service hints. Each TV manual is a practical treatise on servicing the year's sets, with giant blueprints, patterns, waveforms, hints, charts, suggested changes. See coupon at right for a complete list of these low-priced manuals.

Supreme Publications

Sold by All Leading Radio Jobbers

NO-RISK TRIAL ORDER COUPON

SUPREME PUBLICATIONS, 3727 W. 13th St., Chicago 23, ILL.

Radio Diagram Manuals

- New 1952 Manual, \$2.50
- 1951 Radio
- 1950 Manual
- 1949 Radio
- 1948
- 1947
- 1946
- 1942
- 1941
- 1940
- 1939
- 1926-1938 Manual, \$2.50

EACH
\$2.50
PRICED
AT ONLY
\$2
EACH

Send Radio and TV manuals checked at left and below. Satisfaction guaranteed or money back.

- Complete RADIO COURSE (22 lessons +) \$2.50
- 1952 Television Manual, \$3.
- 1950 Television Manual, \$3.
- 1948 TV, \$3.
- 1951 TV, \$3.
- 1949 TV, \$3.
- 1947 TV & FM, only \$2.

- I am enclosing \$..... Send postpaid.
- Send C.O.D. I am enclosing \$..... deposit.

Name:

Address:

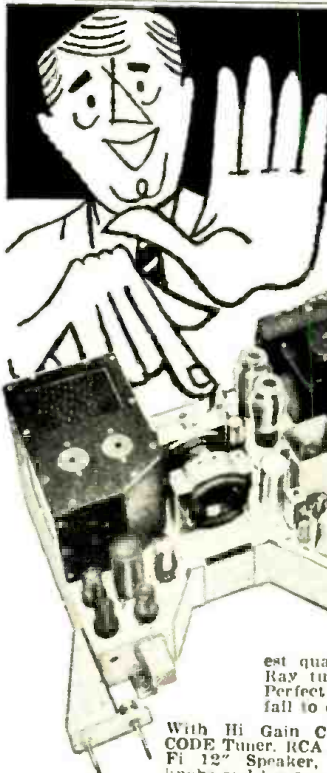

DON'T BUY BEFORE CHECKING STEVE-EL'S PRICES!

NEW IMPROVED 1953 630 TV CHASSIS

now only **\$146.50**

FEATURES: Manufacturer licensed under RCA patents • 30 tube TV receiver (including 3 rectifiers) • FREE replacement on defective tubes and parts • Full channel coverage • Discriminator-type FM sound system • Improved picture brilliance • AFC horizontal hold • Keyed AGC • Stabilized vertical hold • 3 stage sync. separator and clipper • Automatic brightness control • 4 Mc band width • High-Ray tube sizes and types. 16", 17", 19" 20" and 24" Tubes. Perfect for Fringe Area Reception.—Will work where most sets fail to operate.

With Hi Gain CAS-CODE Tuner, RCA Hi-Fi 12" Speaker, all knobs and hwre. **\$146.50**

630 DF Chassis—Extra power for fringe areas. No need for booster or complicated antenna ... **\$161.50**

Cathode Ray chassis mounting brackets for above \$4.95

SPECIAL TUBE SALE!

FULLY GUARANTEED—INDIVIDUALLY BOXED tubes at sensational low prices. Stock up now! Quantities limited!

1B3GT. \$.63	6B06 ..\$.76	6V6GT. \$.46	12SL7. \$.57
1U4 ..\$.48	6B07 ..\$.86	6V8 ..\$.83	12SN7 ..\$.54
1U5 ..\$.48	6CB6 ..\$.48	6W3 ..\$.44	12SQ7 ..\$.42
1X2 ..\$.68	6F6GT. \$.49	6W6 ..\$.52	19T8 ..\$.64
5W4GT. \$.46	6I6 ..\$.79	6X4 ..\$.34	25BQ5 ..\$.77
5Y3GT. \$.29	6L6G ..\$.89	7X7 ..\$.62	25W4 ..\$.48
6A7 ..\$.62	6SA7 ..\$.52	12AT6 ..\$.48	25L6 ..\$.48
6AG5 ..\$.59	6SG7GT. \$.49	12AU6 ..\$.48	25Z6 ..\$.42
6AK5 ..\$.14	6SK7 ..\$.49	12AU7 ..\$.56	35C5 ..\$.57
6BC5 ..\$.58	6SL7 ..\$.52	12AV6 ..\$.52	35L6 ..\$.48
6BE6 ..\$.48	6SN7 ..\$.54	12A27 ..\$.84	35Z3 ..\$.33
6BG6 ..\$.121	6SQ7 ..\$.42	12BA6 ..\$.47	50L6 ..\$.48
6BH6 ..\$.62	6T8 ..\$.74	12SA7 ..\$.52	80 ..\$.48
6BJ6 ..\$.53	6U6 ..\$.57	12SK7 ..\$.49	

TV PICTURE TUBES

10BP4 . \$17.95	16GP4 . \$26.00	19AP4 . \$31.40
12LP4 . 19.95	16HP4 . 19.95	20CP4 . 32.00
14BP4 . 19.95	16KP4 . 23.40	21EP4 . 34.40
16AP4 . 26.40	17BP4 . 23.40	24AP4 . 59.60

All brand new—standard brands

GUARANTEED FOR ONE FULL YEAR!

TAPE RECORDERS

Welcor 210	\$144.50
Pentron 9T3C	117.50
Tape Master PT-125 Recording Unit	89.50
SA-13 Power Amplifier and Speaker	69.50

FREE! FREE!

Write for latest catalog of hundreds of "rock bottom" values!

STEVE-EL ELECTRONICS CORP.

VISIT OUR NEW STORE

Dept. N-1 61 Reade St., New York 7, N. Y. CORtlandt 7-0086

FEDERATED OFFERS THE NEW LOW-PRICED RCA JUNIOR VOLTOHMST



FEATURES YOU WANT

- High input resistance on all ranges . . . 11 meg for D.C. . . . 0.2 to 2 meg for A.C.
- Zero centering for discriminator alignment
- Ohms Probe always positive
- Only 2 test leads — Direct probe measures A.C. and Ohms — D.C. probe slips over direct probe for D.C. measurements
- Flat frequency response: 30 cps to 3 mc. 50 Kc to 250 Mc with WG-264 X-tal diode probe (available as accessory)



RANGES

- D.C. Volts: 0-3, 12, 60, 300, 1200
- A.C. Volts: 0-3, 12, 60, 300, 1200
- Resistance: 0 to 1,000,000,000 ohms in 5 ranges . . . center scale values at 10, 1,000, 10,000, 1.0 meg. & 10 meg.

WV-77A

COMPLETE WITH TUBES, BATTERY, PROBES & CABLE AND INSTRUCTION BOOKLET. FULLY ASSEMBLED AND CALIBRATED . . . JUST PLUG-IN AND OPERATE!

NOW ONLY **\$47.50** NET

IN STOCK AT YOUR NEAREST **FEDERATED OUTLET**

*Registered U.S. Pat. Off.

Nation's Only Coast-To-Coast Electronics Distributor

Federated Purchaser

- New York City 7, N. Y., 66 Dey St.,
- Newark, N. J., 114 Hudson St.,
- Allentown, Pa., 1115 Hamilton St.,
- Easton, Pa., 925 Northampton St.,

WRL CATALOGUE

World Radio Laboratories, Inc., 744 West Broadway, Council Bluffs, Iowa, has announced the issuance of a new catalogue covering electronic components.

Comprising 130 pages, the new WRL catalogue lists many new items of interest to the purchasers of all types of amateur and other electronic equipment and components. Copies are available on request.

AUDIO CATALOGUE

Harvey Radio Company, Inc., 103 West 43rd Street, New York 36, New York, has issued a new catalogue devoted exclusively to high-fidelity audio equipment.

Designated as Catalogue No. 54, this new 36-page publication lists hundreds of items for the audiophile. Included are AM-FM chassis and tuners, amplifiers, baffles, cabinets, cartridges, changers, disc recorders, equalizer-preamps, high-fidelity speakers, pickups, phonographs, tape units, etc.

In order to insure maximum usability, the company has not only listed and illustrated each piece of equipment but provided technical data and performance information.

MAGNETIC DOOR LATCH

A catalogue sheet which describes all of the features of its new magnetic door latch is now available from Heppner Sales Company, Round Lake, Illinois.

The product described in the sheet is suitable for either wood or metal doors, retains its magnetic properties, and since it incorporates no working parts, will last indefinitely.

HAM BOOKLET

The Allied Radio Corporation, 833 West Jackson Boulevard, Chicago 7, Illinois, in cooperation with the ARRL, is distributing a free booklet to radio clubs, radio classes, and all other groups of radio or electronic students or hobbyists.

The booklet, "You Can Be There," is a dramatic story of the romance of amateur radio and the thrills that come with the hobby of operating a ham station.

Instructors of radio classes, officers

RADIO & TELEVISION NEWS

Standard R.M.A. Warranty	TUBES	Overnight Air or P.P. Service
0A2 \$.95	6AN5 2.00	310-A(WE) 5.95
0B2 1.10	6C449	40R-A(WE) 2.75
1N23-A 2.45	6J6 2.50	717 9.98
1N23-B 3.70	7C30 85.00	805 2.50
1N3464	12A665	807 1.59
1N34-A75	12AU769	868-A 1.55
1N5485	6CS-Hytron C.R. 872-A(GE) 3.75	
2C43(GE) 15.95	Tubes: 1616	1.74
2E24 2.75	17BP4A 24.75	1622/6L6M 1.95
2E30 2.15	20CP4A 38.50	162539
4X150-A 27.50	21EP4A 38.50	5E54 2.00
5PP7 1.95	250-TH 18.75	5E92 (RCA) 7.95
5U4-G85	304-TH 7.00	9001 1.35
5X4-G85	304-TL 8.75	9004 (RCA)39
6AK575		

SELENIUM RECTIFIERS—FULL-WAVE BRIDGE TYPES

Current (Continuous)	18/14 Volts	36/28 Volts	54/42 Volts	130/100 Volts
1 Amp.	\$1.35	\$2.15	\$3.70	\$7.50
2 Amps.	2.20	3.60	5.40	10.50
2½ Amps.	—	—	6.00	13.00
4 Amps.	4.25	6.75	10.25	—
5 Amps.	4.95	7.95	12.95	25.25
6 Amps.	4.75	9.00	13.50	33.00
10 Amps.	6.75	12.75	20.00	40.00
12 Amps.	8.50	16.25	25.50	45.00
20 Amps.	13.25	25.50	39.00	79.50
24 Amps.	16.25	32.50	45.00	90.00
30 Amps.	20.00	38.50	—	—
36 Amps.	25.00	48.50	—	—

- New, Selenium Rectifier Transformers
- 115V. PRI.—60 cycles in. 1 Amps. \$ 8.75
- SEC: 0, 12, 18, 24, and 36 12 Amps. 16.75
- volts. 24 Amps. 35.75
- 115V. PRI.—36V. 50 amp second XFMR. \$39.95
- 115V. PRI.—5V @ 190 Amp. SEC. \$59.95
- 115/230V. 60 cy. PRI. SEC.: 1.5, 30.5, 33.5, and 36.5V. @ 4 Amps. Term. Sealed \$6.50
- New Selenium Rectifier Chokes
- 4 Amps.—.07 hy.—6 ohm \$7.95
- 12 Amps.—.01 hy.—1 ohm \$14.95
- 24 Amps.—.004 hy.—.025 ohm \$29.95

We can manufacture other Selenium Rectifiers, Selenium Rectifier Supplies, XFMRs., & Chokes.

SOLA HEAVY-DUTY PLATE TRANSFORMER.
PRI: 200, 220, 240 volts—60 cy.
SEC: 700-0-700 @ conservative 200 MA. 3"X8"X
6½" NEW-Wt. 19 lbs. Special @ **\$17.50**

• CARTER DYNAMOTORS 6 V DC Input—500 VDC Output @ 150 MA. Only 7" X 4" X 3". **\$28.00**
In Orig. Mfr's Cartons. Only

• AR-11—SUPERNET RCVR. & 50 WATT XMTR w/built-in 110 vac. powr. supply. Unit 12"X8"X5" for 20, 40, & 80 meters. Brand New. A complete station for only **\$99.50**



136 Liberty Street, N. Y. 6, N. Y. REctor 2-2562.
Terms: 25% with order, balance C.O.D.—Send a few cents for postage—All merchandise guaranteed. F.O.B. N.Y.C. Remember, you may order tubes not listed!

ELECTRONIC'S LATEST TROUBLE-SHOOTER

A compact—complete—circuit analyzer

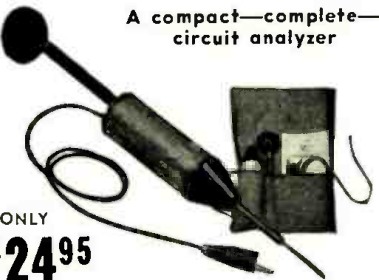

ONLY **\$24.95**

THE AMAZING TV SERVISSET

Model E-C (Pat. Pending)

A precision engineered professional quality electronic test instrument. Ideal for field or bench servicing of Radio, Television, Radar, Communications gear, etc.

Now—Quickly—Conveniently—At Low Cost

CHECKS: sync, sweep, video, audio elements, TV high voltage supplies (DC, RF, or Pulse), low voltage supplies, coils, condensers, resistors, tubes, transformers, speakers, etc. Will localize trouble to a particular stage, determine defective component and can actually be clamped in circuit to restore circuit operation temporarily in 80% of component or tube defects. Ideal for locating and confirming intermittents.

SPECIFICATIONS:

RF & AF Signal Tracer, RF & AF Signal Injector, AC & DC Voltage Indicator 0-60/550/20,000 DC Polarity Indicator 60/550/20,000 volts, Lo Ohms 0-5, Hi Ohms 0-500k-20 megohms, Tests Condensers .00025-12 mfd., Tests Resistors 2 ohms—20 megohms, 2 Capacitance Sub ranges .01-1 & 4-40 mfd., 3 Resistance Sub ranges 50-500 ohms, 5k-25k, 100k-1 meg.

Will complement your existing equipment and will outperform other testers costing many times more.

A MUST FOR THE MODERN TV AND ELECTRONICS SERVICE ENGINEER.

Comes in handy cloth pouch, complete with all accessories including ALNICO phone, TV high voltage adapter, phone extension cord, test lead, Klipzon adapter and complete detailed Instruction Manual, disclosing latest TV trouble-shooting techniques.

Be sure to ask for and see SERVISSET at your distributor or send today for complete information and name of your local distributor.

LEE ELECTRONIC LABS., INC.
233 Dudley Street Boston 19, Mass.

Six Months from Today Which will YOU hold?

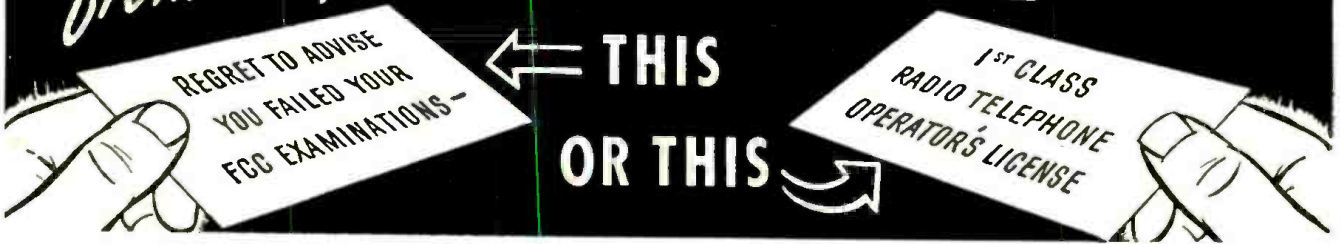

ADD TECHNICAL TRAINING TO YOUR PRACTICAL EXPERIENCE

GET YOUR FCC LICENSE IN A HURRY!

Then use our Amazingly Effective
JOB-FINDING SERVICE

Get this Valuable Booklet **FREE**



TELEVISION ENGINEERING included in our Training and Coaching

HERE IS YOUR GUARANTEE

TELLS HOW —

If you fail to pass your Commercial License exam after completing our course, we guarantee to continue your training without additional cost of any kind, until you successfully obtain your Commercial license, provided you first sit for this examination within 90 days after completing your course.

WE GUARANTEE

TO TRAIN AND COACH YOU
AT HOME

IN SPARE TIME UNTIL YOU GET
YOUR FCC LICENSE

If you have had any practical experience—Amateur, Army, Navy, radio repair, or experimenting.

TELLS HOW —

Employers make

**JOB OFFERS Like These
to Our Graduates Every Month**

Letter from Chief Engineer, Broadcast Station, North Carolina. "Need men with radio-telephone 1st class licenses, no experience necessary. Will learn more than at average station for we are equipped with Diesel Electric power, transmitting and studio equipment."
Telegram from Chief Engineer, Broadcast Station, Wyoming. "Please send latest list available first class operators. Have November 10th opening for two combo men."
These are just a few samples of the job offers that come to our office periodically. Some licensed radioman filled each of these jobs... it might have been you!

**HERE'S PROOF FCC LICENSES ARE OFTEN
SECURED IN A FEW HOURS OF STUDY WITH
OUR Coaching AT HOME in Spare Time.**

Name and Address	License	Lessons
Lee Worthy 2210 1/2 Wilshire St., Bakersfield, California	2nd Phone	16
Clifford E. Vogt Box 1010, Tania, Florida	1st Phone	20
Francis X. Foerch 39 Buehler Pl., Bergenfield, New Jersey	1st Phone	38
Sgt. Ben H. Davis 317 North Roosevelt, Letanion, Illinois	1st Phone	38
Albert Schoell 110 West 11th St., Escondido, California	2nd Phone	23

CLEVELAND INSTITUTE OF RADIO ELECTRONICS

CLARE E. SMITH, E. E., Consulting Engineer, President
Desk RN-4B, 4900 Euclid Bldg., Cleveland 3, Ohio

TELLS HOW —

Our Amazingly Effective
JOB-FINDING SERVICE

Helps CIRE Students Get Better Jobs
Here are a few recent examples of Job-Finding results:

GETS CIVIL SERVICE JOB
"Thanks to your course I obtained my 2nd phone license, and am now employed by Civil Service at Great Lakes Naval Training Station as an Equipment Specialist."
Kenneth R. Leiser, Fair Oaks, Md. Del., McHenry, Ill.

GETS STATE POLICE JOB
"I have obtained my 1st class ticket (thanks to your school) and since receiving same I have held good jobs at all times. I am now Chief Radio Operator with the Kentucky State Police."
Edwin P. Healy, 264 E. 3rd St., London, Ky.

GETS BROADCAST JOB
"I wish to thank your Job-Finding Service for the help in securing for me the position of transmitter operator here at WCAE, in Pittsburgh."
Walter Koschik, 1442 Ridge Ave., N. Braddock, Pa.

GETS AIRLINES JOB
"Due to your Job-Finding Service, I have been getting many offers from all over the country, and I have taken a job with Capital Airlines in Chicago, as a Radio Mechanic."
Harry Clare, 4537 S. Drexel Blvd., Chicago, Ill.

Your FCC Ticket is recognized in all radio fields as proof of your technical ability

OURS IS THE ONLY HOME STUDY COURSE WHICH SUPPLIES FCC-TYPE EXAMINATIONS WITH ALL LESSONS AND FINAL TESTS.



Get All 3 FREE

MAIL COUPON NOW

CLEVELAND INSTITUTE OF RADIO ELECTRONICS
Desk RN-4B—4900 Euclid Bldg., Cleveland 3, Ohio
(Address to Desk No. to avoid delay)

I want to know how I can get my FCC ticket in a minimum of time. Send me your FREE booklet, "How to Pass FCC License Examinations" (does not cover exams for Amateur License), as well as a sample FCC-type exam and the valuable booklet, "Money-Making FCC License Information."
 Tell me about your Television Engineering Course.

NAME

ADDRESS

CITY..... ZONE..... STATE.....

Paste on two-cent postcard or send air mail

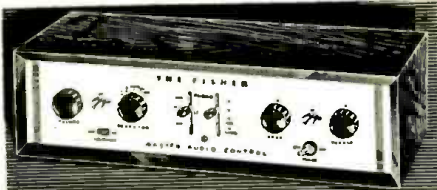

PREAMPLIFIER-EQUALIZER • MODEL 50-C

THE HIT of the
AUDIO FAIR!

The Fisher Master Audio Control

MODEL 50-C

■ This is the equipment (50-C and 50-A) used to reproduce WQXR's binaural broadcast to the AES Annual Banquet. You can pay considerably more but you cannot buy finer! THE FISHER Master Audio Control can be used with any amplifier. Intermodulation distortion is virtually unmeasurable; complete, professional phonograph equalization settings and tone controls; genuine F.M. loudness control; 5 inputs and 5 independent input level controls; cathode follower outputs. Finest preamplifier. Self-powered.

As shown, 50-C: \$97.50
Chassis only, 50-CII: \$89.50

The Fisher All-Triode Amplifier

MODEL 50-A

■ THE FISHER Laboratory Standard Amplifier is, beyond a shadow of a doubt, the world's finest all-triode amplifier—and yet moderately priced! FEATURES: High output—less than .3% harmonic distortion at 40 watts (.08% at 10 watts.) Intermodulation distortion below .8% at 40 watts. Uniform response within .1 db. 20-20,000 cycles; 1 db. 5 to 100,000 cycles. Hum and noise better than 98 db below full output. Quality components used throughout. Beautiful workmanship. \$159.50

Write for illustrated brochure

FISHER RADIO CORPORATION
39 EAST 47th STREET • NEW YORK
ALL-TRIODE AMPLIFIER • MODEL 50-A

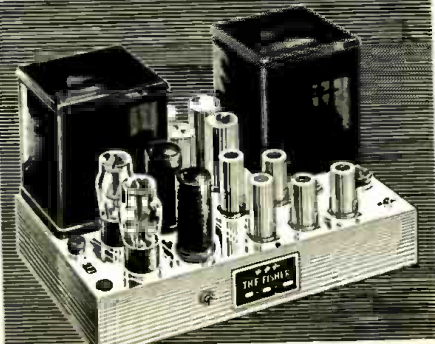

and sponsors of clubs and other groups can obtain any number of copies of the free booklet by writing to Zole Csolkovits, W9TXZ at the above address.

TRANSFORMER CATALOGUE

Milwaukee Transformer Company, 5231 North Hopkins Street, Milwaukee 9, Wisconsin, has just released a new, 16-page catalogue to the electronic trade.

Designated as catalogue MTR-1, the new publication describes a varied line of transformers, reactors, filter networks, and similar components which have been specially engineered to the rigid requirements of commercial and government agencies.

-30-

Headlight Dimmer

(Continued from page 35)

second stage because without heater excitation no plate current can flow. The current drain on all the batteries is very low and they should provide almost shelf life. The circuit could be designed to use the auto battery as one of the bias cells as well as for heater power but this is not advisable because the grid voltages are quite critical and the 6 volt system in an automobile varies considerably with engine speed.

A 0.01 μ fd. condenser is connected from grid to cathode of each stage to prevent any a.c. voltages from appearing at those points. If this precaution were not taken, the circuit might oscillate and would surely pick up ignition noise and possibly even r.f. It is the combination of C_1 and R_1 in the first stage that gives the circuit the slow reaction to changes of light intensity. This reaction can be slowed even more by increasing the value of C_1 .

The sensitive relay in the plate circuit of the second stage of the amplifier has a 10,000 ohm coil and can be adjusted to close at about 2 milliam-

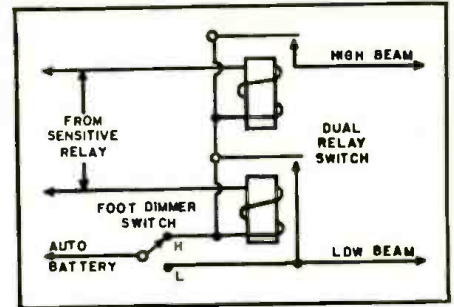

Wiring diagram for a conventional auto headlight system. See text for details.

peres. The contacts form a single-pole, double-throw switch. The armature of the relay is grounded. The normally-closed contact goes to the relay switch operating the "high" lights and the normally open contact goes to the relay operating the "low" lights.

The unit was constructed in a small aluminum box 8" x 6" x 4". Care must be taken to mount the sensitive relay in a horizontal position so the vibration of the auto cannot interrupt its operation. Also, the resistance between the grid and cathode of the first stage of the amplifier should be kept as high as possible because a resistance of less than 10 megohms will cause considerable loss of sensitivity. Four wires are brought out of the box—one for filament power, two for the headlight relay switches, and one for the phototube. The wire for the phototube is shielded to prevent any stray pickup. The entire unit is mounted on two aluminum flanges beneath the dash panel of the automobile. The phototube can be mounted behind the windshield in any convenient place.

This unit was installed on a 1946 Chevrolet and a dual headlight relay had to be installed on that car. The wiring of the headlight control system would have to be adapted to the particular car, of course. In any case, the foot dimmer switch should be wired to override the photoelectric dimmer as a safety precaution.

-30-

Over-all view of the complete photoelectric headlight dimmer unit.

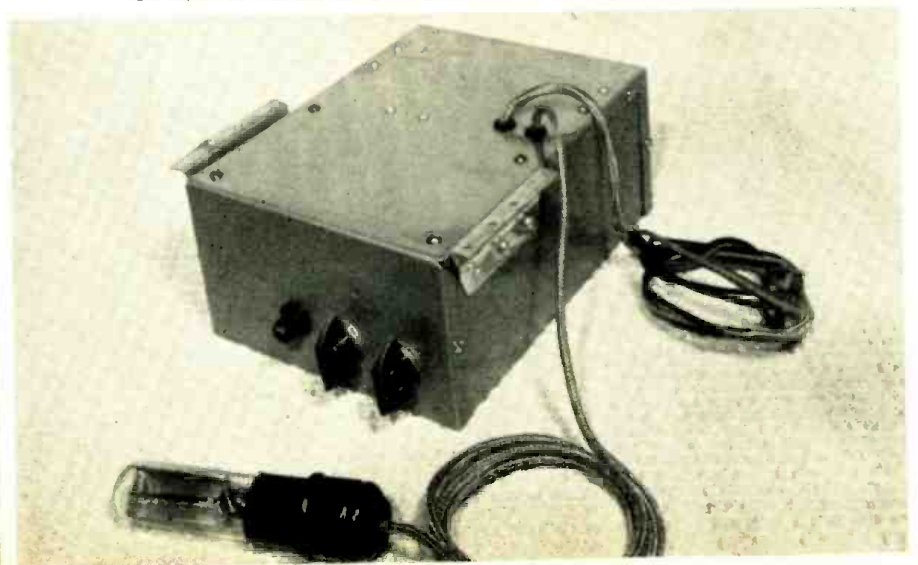

Great, New 1953 Model 630-DX CHASSIS

terrific savings immediate delivery

Includes newest developments—Cascode Tuner—30 Tubes—for 16" to 24" Picture Tube—Wonderful Savings! Adaptable for color and UHF!

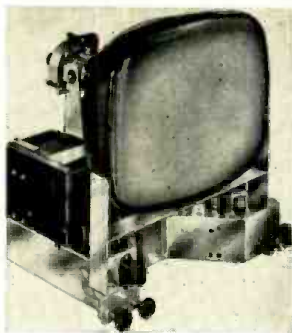

The great 630 with all the up-to-date improvements! Wonderful reception on long range up to 200 miles without a booster is yours today at this low-low price. Gives 3-times normal reception. Special super high-gain standard coil tuner gives greater sensitivity, top performance on any channel. Aligned and tested for 5 hours. molded condensers. 4 microvolts sensitivity. FM sound system. horizontal and linear lock and is directly adaptable for color and UHF.

Model 630 DX-1: RMA Guaranteed—Factory Wired, ready to play. Complete with 12" speaker, hardware and knobs.

14950
(less CRT)

FREE: New Trouble Shooting book with any chassis!

SUPER 630 DX-2 TV CHASSIS

Includes the same features as the 630 DX-1 chassis PLUS the following:

- ★ Keyed AGC level control
- ★ Cornell-Dubilier plastic molded condensers
- ★ 4.5 Megacycle wave trap to eliminate interference
- ★ Photo input & switch which cuts out high voltage supply
- ★ ICA matched 70° cosine yoke & Hi-Voltage transformer
- ★ Four 6.3 CB6 tubes in video IF strip
- ★ ICA 12" Speaker

Net Price Complete **15950** (less CRT)

SUPER DELUXE 630-DX-3 CHASSIS with Push-Pull Audio Output.

Includes same features as 630 DX-2 chassis, PLUS the following:

- ★ Push-Pull audio output
- ★ Frequency response from 80-15,000 cycles at ± 1.5 db.
- ★ Tapped for 4 & 8 ohm speakers
- ★ High quality ICA 12" PM speaker

Net Price Complete **16950**

Universal Mounting Brackets...\$5.95

SCOOP AM Radio tuner, made especially for any 630 or 630 DX Chassis. Complete with simple instructions, ready to install, fits in the well of TV chassis. **ROSE Special 1495 ca.**

Great Values	TV PICTURE TUBES	Full Year's Guarantee—Black Face—Brand New, Standard Brands			
108P4	\$19.95	16GP4	\$32.95	20CP4A	\$35.95
12LP4A	22.95	16KP4	26.95	21FP4A	36.95
148P4	23.95	17BP4A	23.95	24AP4	68.95
14CP4	23.95	19AP4A	35.95	27EP4	92.95
16AP4A	32.95				

ORDER NOW FOR IMMEDIATE DELIVERY

The ROSE Company

102 Park Place, Dept. R-1, New York 7, N. Y., COrtlandt 7-6195

WRITE FOR CATALOG: MIN. ORDER: \$5.00. 25% with order, balance C.O.D. Include postage with order. All merchandise subject to prior sale. Prices subject to change without notice. P.O.B. New York City.

BUILD 15 RADIOS AT HOME ONLY

With the New Improved 1953 Progressive Radio "EDU-KIT" **\$19.95**

NOW INCLUDES
SIGNAL TRACER
and
CODE OSCILLATOR



- FREE TOOLS WITH KIT
- ABSOLUTELY NO KNOWLEDGE OF RADIO NECESSARY
- NO ADDITIONAL PARTS NEEDED
- EXCELLENT BACKGROUND FOR TELEVISION
- 10 DAY MONEY-BACK GUARANTEE

WHAT THE PROGRESSIVE RADIO "EDU-KIT" OFFERS YOU

The Progressive Radio "Edu-Kit" offers you a home study course at a rock bottom price. Our Kit is designed to train Radio Technicians, with the basic facts of Radio Theory and Construction Practice expressed simply and clearly. You will gain a knowledge of basic Radio Principles involved in Radio Reception, Radio Transmission and Audio Amplification.

You will learn how to identify Radio Symbols and Diagrams; how to build radios, using regular radio circuit schematics; how to mount various radio parts; how to wire and solder in a professional manner. You will learn how to operate Receivers, Transmitters, and Audio Amplifiers. You will learn how to service and trouble-shoot radios.

You will learn code. You will receive training for F.C.C. license. In brief, you will receive a basic education in Radio exactly like the kind you would expect to receive in a Radio Course costing several hundreds of dollars.

THE KIT FOR EVERYONE

The Progressive Radio "Edu-Kit" was specifically prepared for any person who has a desire to learn Radio. The Kit has been used successfully by young and old in all parts of the world. It is not necessary that you have even the slightest background in science or radio.

The Progressive Radio "Edu-Kit" is used by many Radio Schools and Clubs in this country and abroad. It is used by the Veterans Administration for Vocational Guidance and Training.

The Progressive Radio "Edu-Kit" requires no Instructor. All instructions are included. All parts are individually boxed, and identified by name, photograph and diagram. Every step involved in building these sets is carefully explained. You cannot make a mistake.

PROGRESSIVE TEACHING METHOD

The Progressive Radio "Edu-Kit" comes complete with instructions. These instructions are arranged in a clear, simple and progressive manner. The theory of Radio Transmission, Radio Reception, Audio Amplification and servicing by Signal Tracing is clearly explained. Every part is identified by photograph and diagram. You will learn the function and theory of every part used.

The Progressive Radio "Edu-Kit" uses the principle of "Learn by Doing." Therefore you will build radios to illustrate the principles which you learn. These radios are designed in a modern manner, according to the best principles of present-day educational practice. You begin by building a simple radio. The next set that you build is slightly more advanced. Gradually, in a progressive manner, you will find yourself constructing still more advanced radio sets, and doing work like a professional Radio Technician. Altogether you will build fifteen radios, including Receivers, Transmitters, Amplifiers, Code Oscillator and Signal Tracer.

The Progressive Radio "EDU-KIT" Is Complete

You will receive every part necessary to build 15 different radio sets. Our kits contain tubes, tube sockets, chassis, variable condensers, mica condensers, paper condensers, resistors, fine cords, selenium rectifiers, tie strips, coils, hardware, tubing, hook-up wire, solder, etc.

Every part that you need is included. These parts are individually packaged, so that you can easily identify every item. Tools are included, as well as an Electrical and Radio Tester. Complete, easy-to-follow instructions are provided.

In addition, the "Edu-Kit" now contains lessons for servicing with the Progressive Signal Tracer, F.C.C. instructions, quizzes. The "Edu-Kit" is a complete radio course, down to the smallest detail.

TROUBLE-SHOOTING LESSONS

Trouble-shooting and servicing are included. You will be taught to recognize and repair troubles. You will build and learn to operate a professional Signal Tracer. You receive an Electrical and Radio Tester, and learn to use it for radio repairs. While you are learning in this practical way, you will be able to do many a repair job for your neighbors and friends, and charge fees which will far exceed the cost of the "Edu-Kit." Here is your opportunity to learn radio quickly and easily, and have others pay for it. Our Consultation Service will help you with any technical problems which you may have.

FREE EXTRAS IN 1953

- ELECTRICAL AND RADIO TESTER
- ELECTRIC SOLDERING IRON
- BOOK ON TELEVISION
- RADIO TROUBLE-SHOOTING GUIDE
- MEMBERSHIP IN RADIO-TELEVISION CLUB
- CONSULTATION SERVICE
- QUIZZES
- TRAINING FOR F.C.C. LICENSE

The Progressive Radio "Edu-Kit" is sold with a 10-day money-back guarantee. Order your Progressive Radio "EDU-KIT" Today, or send for further information.

We pay shipping charges all over the world. If you send check or money order for \$19.95 with your order. On C.O.D. orders, you pay cost of delivery.

PROGRESSIVE ELECTRONICS CO.

497 UNION AVE., RN-14, Brooklyn 11, N. Y.

NOW!
A
T.V. TEST PATTERN
WHENEVER
You NEED one

use
MODEL CB-101
UTL PATTERN GENERATOR
SIMPLE • EFFICIENT • ACCURATE
for a STEADY NON-SHIFTING
VERTICAL or HORIZONTAL
TEST PATTERN

HERE'S WHY YOU'LL LIKE IT...

- ★ Makes horizontal and vertical linearity, width, height and centering tests.
- ★ Checks relative gain of video stages; isolates defects in video amplifier.
- ★ Tests performance of kinescope directly.
- ★ Checks overall image reproduction when used to modulate TV signal generator.
- ★ Uses sync impulse of receiver to insure steady line or bar pattern.
- ★ No removal of chassis necessary; special leads connect to tube pins.

— Ask your distributor about it.

Send for free folder No. 32

\$29.50
COMPLETE WITH SHIELDED LEADS

UNITED TECHNICAL LABORATORIES

Engineers • MORRISTOWN, N. J. • Manufacturers

THE NEW

Regency

VB-1 Voltage Booster*

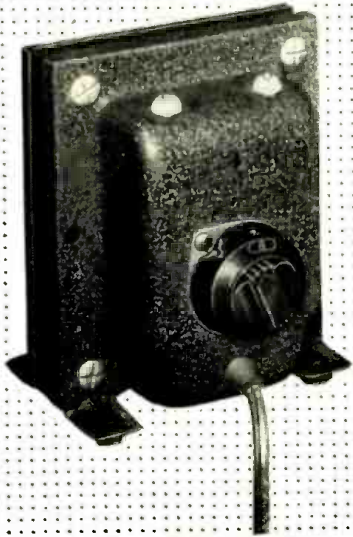

Get peak performance from your TV set or any electrical device drawing 350 watts or less. This manually operated autotransformer maintains full 117 volt power supply. Insures full size TV picture when low line voltage shrinks picture size.

THE VB-1, \$19.95 LIST

*by the makers of the Regency VHF TV booster and UHF TV converter

Ask any radio parts jobber for further information or write:

I.D.E.A., INC., REGENCY DIVISION
7900 Pendleton Pike, Indianapolis 26
Cherry 2466

TV Signal Tracing (Continued from page 51)

of the horizontal-output tube, its effect can be reduced to an insignificant level by both direct contact of the probe tip to the tube cap and manipulation of the probe body for minimum capacitance pickup. Actually, direct contact lowers the probe input impedance, making it less sensitive to the crosstalk field.

The small short ripple, which follows the pulse in Fig. 2B but is not apparent in Fig. 2A, is a characteristic found at the deflection voltage level. It is referred to by design engineers as the "Spook". (The spook may be noticed on television screens as a fine vertical line very close to the left edge of the raster.)

Hum

Hum also presents a continuous but not too serious problem in high-voltage signal tracing in that it spreads the horizontal lines of a high-voltage waveform vertically, as shown in Fig. 3. Very little hum interference comes through the probe-tip contact because a rather high ratio of high voltage to hum voltage exists at that point. Hum introduced near the handle of the probe, however, mixes with the high-voltage signal after the signal level is reduced by the probe resistor. Fig. 3 shows amplitude expansion of horizontal lines due to hum voltage originating in the field of a *Variac* placed near the probe handle. If the source of hum cannot be removed, movement of the probe to a different angle of approach will usually reduce the hum effect to an insignificant level. As a matter of note, strong video signals or vertical-deflection signals, or either of these mixed with hum, will cause distortion similar to hum alone.

Effect of Reduced Voltages

Low supply voltage (low line voltage, low "B+" voltage, or low boosted "B+" voltage) is another possible cause of waveform distortion, particularly because it affects pulse shape and amplitude. The three exposures in Fig. 5 are expanded trace views showing how pulse amplitude diminishes with decreasing supply voltage. These pictures, obtained by probe contact at the plate of horizontal output tube, show a simultaneous reduction of the wavetrain following the pulse.

Reduction of heater voltage at the damper tube may also cause reduced pulse amplitude along with distortion in the wavetrain as shown in Fig. 6. Reduced cathode emission within the damper tube produces a similar effect.

The use of a d.c. oscilloscope for examination of these waveshapes has one special advantage; three standard conditions of "B" voltage can be rechecked conveniently when desired. The triple exposure in Fig. 4, made with probe contact at the damper-

CODE SENDING RECEPTIVE SPEED

HIGH SPEED WITHOUT NERVOUS TENSION

REVEALING BOOK shows how "crack" operators develop high speed and proficiency. Learn code for Amateur or Commercial Radiotelegraph License, or improve your sending and receiving.

With the Candier System which develops radiotelegraph experts and code champions.

CANDLER SYSTEM CO. FREE

Box 928, Dept. 2-A, Denver, Colo.

BENDIX 4-CHANNEL E.C.O.

Channel 1 1050-1700 KC Channel 2 2000-3400 KC Channel 3 3000-4800 KC Channel 4 4370-7000 KC



Unit is front end of TA-12B transmitter by band switching each channel is a complete oscillator uses a 4SK7 or 12SK7 in each channel by adding an 807 driver and a pair of 807's for a final you have a 50 watt trans. each case section is completely shielded and mounted on an aluminum chassis with var. cond. shafts extended ready to add voltage. GOVT. COST OVER \$150.00 NEW. WHILE THEY LAST. For That New Ham Band 3700 KC. \$5.95

McCONNELL'S

3834 Germantown Ave. Phila., Penna. RA 5-6033

L. A. HAM SHACK SELLS FOR LESS

METERS

WESTON • SANGAMO
ALL NEW • ALL D. C. • 2" SQUARE

0-5 Ma	} EACH	\$3.29
0-15 Ma		
0-50 Ma		
0-100 Ma		
0-200 Ma		
0-300 Ma	or	3 for
0-500 Ma		\$9.00

0-2 Ma \$3.95

Mfg's inquiries: lots over 100

"S" METER
Illuminated face. Full scale reading of 5 ma. A standard value for most "S" Meter Circuits. 2 3/8". Black face.
New \$2.49
Amp Meter. No. 60-0-60. New \$1.29

COMMAND AND/OR ARCS TRANSMITTERS and RECEIVERS

3-6 MC Receiver	Used \$8.95—New \$17.95
6-9.1 Receiver	Used 8.95—New 12.95
Triple Receiver Rack	1.95
V.H.F. ARCS Transmitter or Receiver, Complete w/tubes	Used 24.95

4-5.3 MC Transmitter with tubes	Used 8.95	New
5.3-7 MC Transmitter with tubes	8.95	
7-9.1 MC Transmitter with tubes	9.95	\$19.95
3-4 MC Transmitter with tubes	18.95	
28V Receiver Command Dynamotors	0.97	

MODULATORS

BC-456 with Tubes, less dyn.	2.95
MD-7 Modulator Dynamotor, 28V	2.95
BC-433 Receiver—with tubes	24.95
MN-26C Compass Receiver	24.95
MN-26Y Compass Receiver	24.95
BC-357 Marker Beacon Rec. W.O. Tube	5.95

Cash with order. Prices subject to change without notice. California orders please include 3 1/2% Sales Tax. Please include approximate postage—Excess will be refunded. What Have You in Surplus? Submit

CIVIL AIR DEFENSE or 2 METERS

ARC-4, W/tubes. Good, used	\$24.95
522 Trans.-Receiver. W/tubes. Good, used	69.50
Modulation Transformer. BC-375. New	2.49
BC-306 Antenna Loading	1.95
GP-7 Navy Transmitter: 100 watt master os. Can use on any freq. from 350-9050 kc. by using proper plug-in. With 1 tuning unit.	\$17.95
FL8 Filters—A's, B's, C's	New 1.95
FL5 Filters	New .95
Hand Keys—J-38	New 1.19
Heineman Circuit Breakers	115 V., 20 amp. 1.39 115 V., 5 amp. .97

TRANSFORMERS

12V 24V 2am 110V primary	\$2.95
BC-434 Control	Used—\$1.95 New—\$2.95
Code Tapes for TG-10 15 rolls. New	7.95
BC-906 Absorption Type Freq. Meter Range 150-225 mc. 0.500 DC Microm.	Used \$11.50
Field Phones E-E B's.	Used \$29.50 pr.

DYNAMOTORS

PE103 New Case	\$29.95
PE-73 29V @ 20 amps. output 1000V @ .350 amps.	New 9.95
PE-77 14V @ 40 amps output 1000V @ .350 amps.	New 24.95
RL-42B Antenna Reel Ass. Less wire.	New 9.95

OIL CONDENSERS
Standard Mokes—New

2 mfd 600V	\$0.49
4 mfd 600V	1.39
1 mfd 1000V	.69
3 mfd 4000V	7.95
5 mfd 2500V	1.49
10 mfd 600V	2.95
2 mfd 2500V	3.95
2 mfd 5000V	\$8.95
2 mfd 7500V	29.50

HEAD SETS

HS-30	New \$1.95
HS-23	Used \$2.95
Matching Transformer for HS-30	.69
RG-7U Coax Cable, 97.5 ohms.	foot .08
MIKE CHEST SET "F-1" button	New 2.95

Cash with order. Prices subject to change without notice. California orders please include 3 1/2% Sales Tax. Please include approximate postage—Excess will be refunded. What Have You in Surplus? Submit

L. A. HAM SHACK 1306 BOND STREET, at PICO LOS ANGELES 15, CALIFORNIA

tube cathode, shows zero voltage at the base or lower line, the "B+" voltage above it, and boosted "B+" voltage and pulse waveshape at the top. The "B+" voltage alone remains when anything happens to eliminate the high-voltage pulse.

Typical Waveforms

As previously mentioned, deviation from the normal waveform at the plate of the horizontal output tube indicates failure of components in the high-voltage section of a TV receiver. The series of examples that follows is typical of modern high-voltage circuits. An RCA 17T153 television receiver chassis was employed during waveform photography. In receivers with different circuits, some modification of waveforms can be expected.

Although the normal waveform in Fig. 7A is not entirely clear of cross-talk, it is typical of waveforms found to be satisfactory as a reference for signal tracing. Subsequent illustrations each show singular changes from this normal state. The testing arrangement employed to obtain the normal signal indication of Fig. 7A was retained for all other pictures in the group.

Baseline Distortion

Figs. 7B and 7C illustrate the bent baseline caused by reduced damper-tube emission. In the previous exhibit of this condition in Fig. 6, the general bend in base line is lost because of trace expansion. It can be seen, therefore, that it is advantageous to examine at least a complete cycle of the waveform, digressing only temporarily to observe detail by trace expansion.

Fig. 8 indicates loss of pulse amplitude due to damper tube heater-to-cathode leakage. Usually such leakage is quickly checked by tube replacement but may even be traced to paths external to the tube.

Short-circuited or leaky components place undue loading on the entire deflection circuit and result in loss of pulse amplitude and base-line warping. Various degrees of such conditions are illustrated in Figs. 7B, 7C, 8, 10, 12, 13A, and 14.

Distortion of Pulse Shape

Analysis of the cause of a distorted waveform should also include inspection of the pulse shape. The shape of the pulse is closely related to the proper performance of the deflection output components, such as the horizontal output transformer, the yoke, or the damper tube. The pulse-forming circuit which includes these components has a resonant frequency of approximately 65 kilocycles and there-

Fig. 12. Waveform at plate of horizontal output tube. This pattern is obtained when there is a shorted condenser between "B+" and boosted "B+" circuit.



FREE!
1953 CATALOG

HERE ARE JUST A FEW OF THE
BIG VALUES
IN THE LATEST 148 PAGE
B-A CATALOG

WRITE US IF YOU HAVE NOT RECEIVED IT

BURSTEIN-APPLEBEE CO.

1012-14 McGee St., Kansas City 6, Mo.

Send Free B-A Catalog No. 531.
 My order is attached for items from below.

\$..... enclosed.

Name.....

Address.....

City.....

State.....

35 MA—130 VOLT
SELENIUM RECTIFIER



Very compact 3/4"x1/2" dia. in tubular fibre sleeve, sealed with high temp. wax—easy to mount anywhere with the self supporting 2" tinned wire leads.
An exact replacement for Standard B51 and many other TV boosters and ideal for countless other rectifier needs.
No. 15A1172 35c 10 Lots 29c
Spec. Ea.

16MFD—150 WKG. V.—225 P.V.
TUBULAR ELECTROLYTIC

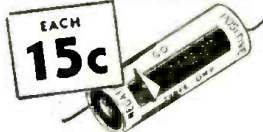

Top make, hermetically sealed in aluminum tube with kraftboard insulating jacket and 3" tinned wire leads. Compact only 1 3/4"x3/8". Fresh stock—fully guaranteed, a widely used capacity at a crazy Low Price.
No. 14B995 15c 10 Lots 13c
Spec. Ea.

36 MOLDED PLASTIC
TUBULAR
CONDENSERS

\$11.70 List Value

\$3.88

Compact, yet with the rugged construction needed to withstand the high temperature in TV, Auto and AC-DC sets. Top quality. Fully guaranteed by the maker as well as B-A.
Kit of 36 all 600 Volt: 4 each .001, .002, .005 and 6 each .01, .02, .05, .1.
No. 15A263 Your Cost..... **\$3.88**
Kit of 36 Paper Tubulars all 600 volt assorted as above. \$10.50 List Value. No. 15A389. **\$2.39**
Kit of 36.....

MIDGET
POWER TRANSFORMER



117 V., 60 cycle AC primary, 110 V. @ 20 MA H.V. Secondary 6.3 V @ .3 amp for Filament. Fully enclosed, compact, size 1 1/2"x1 1/2"x1 1/2"—mtg. ctr. 2 1/2". Color coded leads.
An exact replacement for many popular TV Boosters as well as for use in construction of phono pre-amps, bios. supplies, phono oscillators, etc.
No. 19C714 89c 10 Lots 79c
Special Each
As above: 110 V. @ 40 MA H.V. Secondary. 6.3 V. @ 1 amp. for Filament. Size 1 3/4"x1 3/4"x1 1/2"—2 3/8" ctrs.
No. 19C731 \$1.29 10 Lots \$1.19
Special Each

6AK5 TUBES



Made by Sylvania and bears the name "Standard" because they were originally intended for use in Standard Boosters—otherwise the identical 6AK5 you would get if buying tubes bearing the Sylvania name and for which you pay up to \$2.00 Net Each (List Price \$3.90 Ea.) Here you get 6 for little more than the regular price of 2 and believe us—they are perfect—new—fully guaranteed—a popular type widely used in Radio, TV, Boosters, etc.
No. 70A98. Pkg. of Six 6AK5 Sylvania Made Tubes **\$4.79 ONLY**

ROTARY SWITCHES

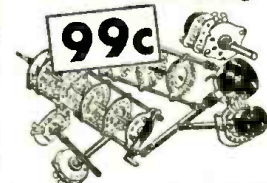

Assortment of TEN—any one of which is worth more than the Price of the lot. Anyone experimenting or building will find Good use for all.
No. 18A436. **99c**
Per Assmt. of TEN.....

SWITCH ASSORTMENT



10 Assorted—toggle, push-button and slide type switches. The use of only several will pay for the lot.
18A935. Per Assmt. Only **\$1.19**

PAPER & MICA CONDENSERS

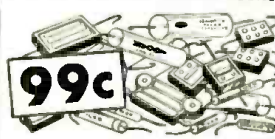

25 assorted useable capacities paper tubular, paper molded and mica condensers. Regular values up to 25c each.
18B203. A Wonderful Value. **99c**

INSULATED RESISTORS



Do not confuse with non-insulated, foreign makes etc. offered by others.
50 Assorted top quality 1/2 watt insulated resistors in most popular capacities.
17A871. Per Assmt. of 50. **\$1.49**
ASSORTMENT OF 100
Consists of 75-1/2 watt and 25-1 watt insulated 1/2 quality resistors
No. 19B79c **\$2.49**
Per Assortment of 100.....

A HEAP OF PARTS



Assembly consists of 140mmf midget variable coil socket, dual crystal socket, RF coil socket, 10 contact terminal strip, resistors, etc., neatly assembled on metal chassis with fibre bottom plate 4" x 1 1/4" x 1 1/8" high. Easy to dis-assemble.
No. 18B1044. **29c**
Per Assembly Only
10 Lots Each **25c**

TRIMMER CONDENSERS



25 Assorted ceramic base mica trimmer condensers. Popular capacities. Regular cost up to 20c each. You can afford to have several assortments, even if the use is only occasional.
No. 18A156. **39c**
PER ASSY. ONLY

6 FT. BROWN AC CORDS



All are of U/L approved size 18-2 conductor zip apart cord and top quality plugs.
No. 19B911 **\$1.69**
Per Bundle of 10.....

FLEXIBLE
MICROPHONE CABLE

Special silver stranding gives extreme flexibility plus unusual tensile strength. Top quality filler, shielding and overall rubber covering. Only 3/8" dia.
No. 28132. **100 Ft. \$2.95**
Per 25' Coil **95c Ft.**

INCLUDE ALLOWANCE FOR POSTAGE—ALL OVERPAYMENTS WILL BE REFUNDED

BURSTEIN-APPLEBEE CO.

1012-14 MCGEE ST.,
KANSAS CITY, MO.

WANTED!

• **RADCOM** pays
• highest prices for surplus
• equipment, parts and tubes

- TCS-7 and up
- SCR 274N, SCR-300
- SCR 399 Equipment JB 70, JB 60, BC-939A, BC-610-E, RA-63, EE8, BC-614-E, PE95, PE197, Trailer K-52, Cords, LS-3
- SCR-508 . . . BC-604, BC-603, FT-237, Crystal Sets
- SCR-506 . . . BC-653-A, BC-652-A, DM-40-A, FT-253-A, BC-658-A
- BC312, 342, 348, 1000 Receivers
- SCR522 Equipment, RA-34 Rectifiers

- ARC-1, ARC-3, ART-13
- Transmitters BC 696, R89/ARN-5A MN 62. Test Equipment SCR-211, I-208, BC211
- Selsyns—All kinds
- Generators—GN 45—All kinds
- 5 KW Gas Generators PE 75, PE 95, PE 197
- Plugs and Connectors. Technical Manuals
- Magnetrons 4J-52, 720-AY—Others
- Tubes—Special Purpose, Lots

Telegraph WUX, Newark

Bigelow 2-6666

Always Right With Earl White

RADCOM Engineering Co. 8 Livingston St. Newark 3, N. J.

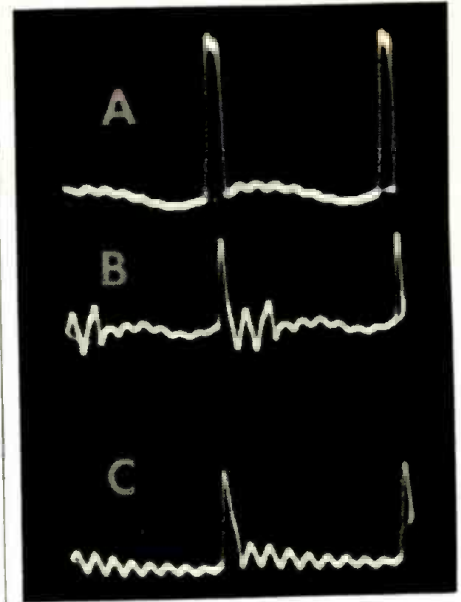

Fig. 13. Waveform at plate of horizontal output tube. Short between horizontal and vertical yoke windings. (A) Low side "H" to "Center V." (B) High side "V" to "Center H." and (C) Low side "V" to "Center H."

DOW SURPLUS

HEADSETS HI-IMP. USED. SPECIAL	\$1.95
HEADSETS H533 LOW-IMP. NEW	5.95
HEADPHONE & CHEST SET NI 2454-B L.N. EA.	2.95
A62 PHANTOM ANTENNA 10 METER. NEW	1.98
1 SECTION 35MMFD VARIABLE CONDENSER	.29
HEINEMANN DUAL CIRCUIT 8 AND 25 AMP	3.49
4 POSITION PUSH BUTTON SWITCH 3 FOR 1.00	
A.C. VOLTMETERS 115V 60CY A.C. LINE	5.95
RANGES 120, 150, NEW	
TELEPHONE WIRE W-130 2-CONDUCTOR 1000 FT. REELS. WEIGHT ONLY 8 LBS.	3.95
GE RELAY COIL & FRAME LESS CONTACTS 12 VOLTS	.49
3 GANG 365 MMFD PER SECT. COND.	.98
4 GANG 365 MMFD PER SECT. COND.	2.95
4 GANG 150 MMFD	.98
5 GANG TUNING CONDENSER	3.95
BAC FUSE POST. NEW	7 FOR 1.00
6V AT 6 AMP BATTERY CHARGER. NEW	6.95
RESISTOR KIT ASSORTED.	100 FOR 1.95
POWER RHEOSTATS	
STANDARD BRANDS: 5 OHM OR 100 OHMS	

TUBES SURPLUS	FUSES
HY615 .50.39	1/8 RAG .03 .25 \$1.95
NE48 .29	1/8 RAG .03 .25 1.95
RK73 .38	1/8 RAG .03 .25 1.95
5561 .29.85	1/8 RAG .03 .25 1.95
VR150 .89	1/8 RAG .03 .25 1.95
1L4S .48	1/8 RAG .03 .25 1.95
2J21A .49.5	1/8 RAG .03 .25 1.95
30P1 .1.95	1/8 RAG .03 .25 1.95
30P1 .1.95	1/8 RAG .03 .25 1.95
5B1 .3.89	1/8 RAG .03 .25 1.95
5DP1 .4.95	1/8 RAG .03 .25 1.95
5F7 .1.49	1/8 RAG .03 .25 1.95
6AC7 .70	1/8 RAG .03 .25 1.95
6AL5 .54	1/8 RAG .03 .25 1.95
6BG6 .1.59	1/8 RAG .03 .25 1.95
6C4 .49	1/8 RAG .03 .25 1.95
6N6 .90	1/8 RAG .03 .25 1.95
6M6 .59	1/8 RAG .03 .25 1.95
6N7 .90	1/8 RAG .03 .25 1.95
6X5 .65	1/8 RAG .03 .25 1.95
6SN7GT .79	1/8 RAG .03 .25 1.95
6SJ7 .89	1/8 RAG .03 .25 1.95
12KB .79	1/8 RAG .03 .25 1.95
41 .89	1/8 RAG .03 .25 1.95
81 .1.69	1/8 RAG .03 .25 1.95
250R .5.95	1/8 RAG .03 .25 1.95
304TL .6.95	1/8 RAG .03 .25 1.95
801A .45	1/8 RAG .03 .25 1.95
803 .3.49	1/8 RAG .03 .25 1.95
805 .3.65	1/8 RAG .03 .25 1.95
837 .1.45	1/8 RAG .03 .25 1.95
843 .39	1/8 RAG .03 .25 1.95
878 .1.45	1/8 RAG .03 .25 1.95
919 .2.49	1/8 RAG .03 .25 1.95
958A .2.49	1/8 RAG .03 .25 1.95
2 FOR 1.00	1/8 RAG .03 .25 1.95
1616 .75	1/8 RAG .03 .25 1.95
1625 .75	1/8 RAG .03 .25 1.95
1629 .29	1/8 RAG .03 .25 1.95
2051 .1.15	1/8 RAG .03 .25 1.95
8012 .2.60	1/8 RAG .03 .25 1.95
8025 .5.39	1/8 RAG .03 .25 1.95
9002 .95	1/8 RAG .03 .25 1.95

EDWARDS BUZZERS	CARBON MIKE	KEYS
1892-115 V-60 cycle .05	RS83, NEW 1.95	J-5A .50.49
15-size 0-12V DC works on 6V less cover. Fine for Code Practice Sets. Ea.	THROAT MIKE	J-30 .1.25
10 for \$4.95	T30, NEW \$1.00	J-32 .1.25
	T-17-D MIKE	J-38 .1.25
	NEW MFG. GUAR	J-41A .89
	T-17-D MIKE	J-47 .1.25
	SURPLUS, GUAR	J-48 .1.25
	470 MFG. CO-AX	
	ANTENNA \$1.95	
	TU-10 TUNING	
	UNITS, New 2.95	
	TU-5 TUNING	
	UNITS, NEW 5.95	

GP 7 TUNING UNITS, B. C. O. E. EA. 2.95	RHEOSTATS	PANEL METERS
	Watts Ohm ea.	NEW SURPLUS
	25 1R \$1.49	3" RD JBT 30F
	25 1R 1.49	48-52 & 58-62 \$14.50
	25 1R 1.49	3" O-1 MA. BASIC 3.95
	25 25 1.49	3" RD 0.15VDC 3.95
	25 100 1.49	3" RD 0.2 VDC 4.95
	25 145 1.49	3" RD 0.5 DB 1.95
	25 150 1.49	3" RD 0-8VAC 3.95
	25 170 1.49	3" WEST 3.95
	25 500 1.98	3" 100-0-100 MIL 4.95
	25 1000 1.95	3" SQ 0-800 MA 4.95
	25 5000 1.95	3" SQ 0-800 MA 4.95
	100 5 3.95	DE JURE 4.95
	100 100 3.95	2" RD 0-3MIL DC 4.95
	150 500 3.95	2" RD 0-5 AMP 2.99
	150 5000 3.95	RF WEST 2.99

Write us for your meter wants. Over 3,000 in stock. Write for Our 16-Page Bulletin.
DOW RADIO, INC.
1759 E. Colorado St. Pasadena 4, Calif.
PHONE: SYcamore 3-1196
\$1.50 min. order 25% deposit with orders
Send full remittance to save C.O.D. charges
All merchandise fully guaranteed. Subject to prior sale.

PEN-OSCIL-LITE

Extremely convenient test oscillator for all radio servicing: alignment • Small as a pen • Self powered • Range from 700 cycles audio to over 600 megacycles u.h.f. • Output from zero to 125 v. • Low in cost • Used by Signal Corps • Write for information.

GENERAL TEST EQUIPMENT
38 Argyle Buffalo 22, N. Y.

Triplet Meters

All Brand New In Boxes

Model	Description	Price
341	0-500 ma. RF 3" rd.	56.50
337A	0-1 amp. A.C. 3" sq.	6.50
232	0-10 volts A.C. 2" rd.	6.50
334	0-15 volts A.C. 3" rd.	6.50
221	400 micro amp. volt-ohm scale 3" rd.	5.00
327A	0-1 ma. D.C. 0-100 bad-good scale 3" sq.	6.50
321T	1-0-1 ma. D.C. zero center scale 3" rd.	8.50
327A	0-60 micro amp. D.C. 0-1000 ohm scale 3" sq.	6.50
327A	0-400 micro amp. D.C. 0-25-50-100 A.C.V. scale 3" sq.	6.50
671	0-5 ma. A.C. 0-5-10-25 A.C. ma. scale 3" sq.	6.50
327A	0-35 ma. D.C. 3" sq.	6.50
327A	6.5 ma. (100 M.V.) 0-5-10-25 D.C. amp. scale 3" sq.	6.50
327A	0-1 ma. 0-10 volts D.C. good-bad scale 3" sq.	6.50
327A	150-0-150 volts D.C. 125 ohms volt 3" sq.	6.50
327A	0-1 ma. D.C. 0-25-50-100 D.C. volt scale 3" sq.	6.50
242T	0-1 ma. D.C. 0-100 scale 2" rd.	5.00
221	0-8 ma. D.C. 0-100 scale 2" rd.	4.50
242T	1.2 ma. D.C. 0-100 scale 2" rd.	4.50
421A	20 ma. D.C. (50 MV.) 0-1 scale 4" sq.	5.00
431	0-300-600 A.C. volts 4" sq.	6.50
1200	Dual 3" meter—50 MV. D.C. 0-100 D.C. amps. and surpressed 3 to 9 volts D.C.	10.50

Our warehouses contain large quantities of Aircraft Instruments, Dynamotors, Capacitors, Switches, Relays, Hydraulic Parts, Potentiometers, etc.

SEND FOR A FREE CATALOGUE
OR CALL ARMOY 4-8989

Electro Devices
INCORPORATED
247 BROADWAY PATERSON, N.J.

by controls the return trace or flyback time. The repetition rate of the pulse is determined by the 15,750 cycle horizontal-oscillator frequency.

Weaknesses in pulse forming circuits, such as open yoke windings, cause the pulse to become broad at the base and round at the top, as shown in Fig. 9B. Pulses having little change in base width but showing deformed peaks indicate trouble in the resonant pulse-forming circuit. Because the tuning of this circuit depends on the proper operation of a number of components, a change in any one of them, or a change in their distributed capacitance, can be responsible for pulse-peak distortion.

Defects in the yoke, the output transformer, the width control, the high-voltage condenser, the horizontal-output tube, the damper tube, or the high-voltage rectifier tube, or even in the associated leads, can individually be the cause of detuning the pulse-forming circuit. With such defects, the pulse shape suffers as shown in Figs. 9A, 11, 13B, 13C, and 14.

Short circuits between horizontal and vertical yoke windings produce different reactions depending upon the sections involved. Fig. 13A shows little change in pulse shape due to a short at the low end of the horizontal winding. When half of the horizontal yoke is involved, however, rapid pulse decay occurs as pictured in Figs. 9A, 13B, 13C, and 14.

Fig. 14. Waveform at plate of horizontal output tube. Condenser shorted and series resistor across half of horizontal yoke winding subsequently was burned.



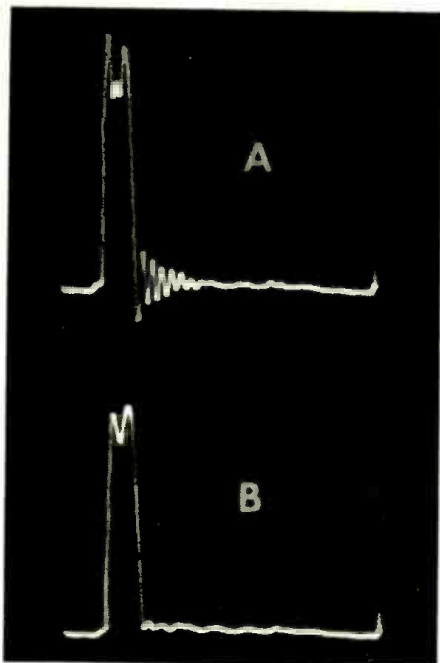

Fig. 15. Horizontal pulse as seen with high-voltage probe at high side of yoke connection. (A) Additional damped wave due to open condenser across half of yoke. (B) Normal waveform with new condenser.

Fig. 14 depicts the waveform associated with a common cause of trouble in the yoke circuits, a shorted neutralizing condenser, and subsequent burnt series resistor across half of the horizontal windings of the yoke. Three principal signs of distortion are evident. 1. The pulse, severely reduced in amplitude, indicates excessive loading of the horizontal deflecting system. 2. The bent baseline is associated with reduced damper-tube conduction, which is concurrent with insufficient pulse power. 3. The rapid decay in pulse shape agrees with other examples of excessive loading across part of the horizontal yoke winding.

If the yoke-neutralizing condenser is open-circuited instead of shorted, it causes no noticeable change in the waveform at the plate of the horizontal-output tube. Open yoke condensers, however, are known to cause "ringing," which is a condition easily recognized by the presence of a series of vertical bars at the left half of the raster. Fig. 15A shows a waveform distinctly associated with this condition. This waveform exhibits the ringing as a damped wavetrain immediately following the pulse. Connection for this test was made by probe contact at the yoke terminal connected to the high side of the horizontal winding.

Although waveforms may differ somewhat with various makes of TV receivers and detailed symptoms may not agree because of circuit or component design differences, high-voltage signal tracing can be universally applied to horizontal-deflection, pulse-type, high-voltage power supplies.

The author wishes to extend a note of appreciation to Mr. B. V. Vonderschmitt for his helpful suggestions.

—R—

at Last!

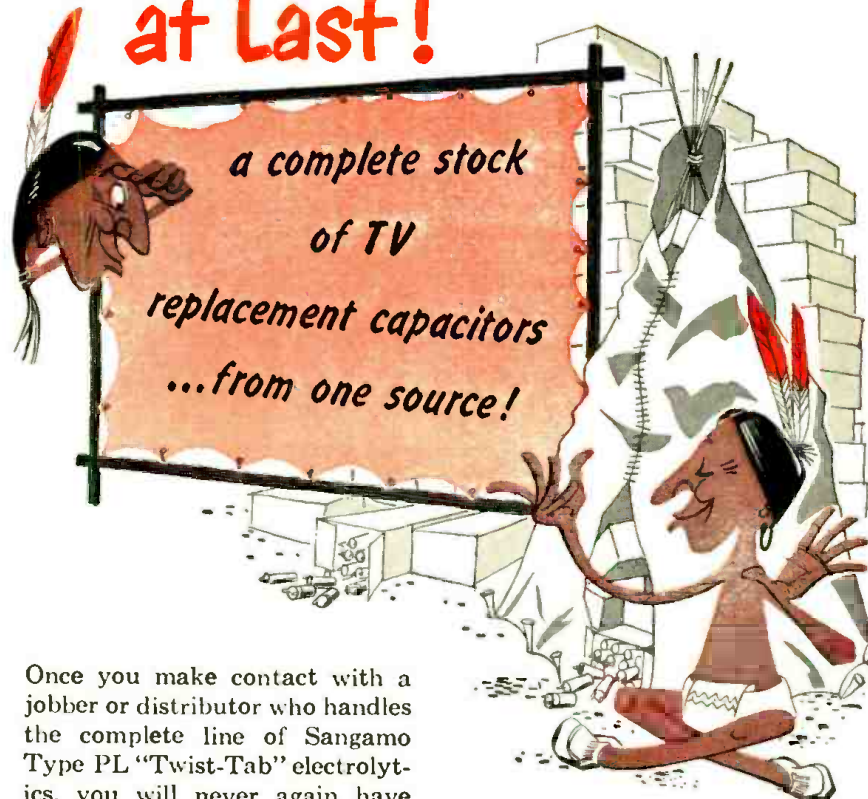

Once you make contact with a jobber or distributor who handles the complete line of Sangamo Type PL "Twist-Tab" electrolytics, you will never again have to "shop around" for odd sizes or capacities. Why? ... because the Sangamo line is the most complete in the industry.

Used by all leading manufacturers of TV sets, Sangamo Type PL "Twist-Tab" electrolytics are exact replacements. They assure long life and dependable performance at 85° C and under conditions of high surge voltages and extreme ripple currents often found in TV applications.

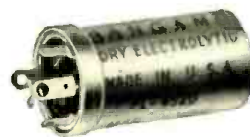

Ask your distributor for a copy of the Sangamo TV Replacement Catalog. It's easy to use and helps you choose the right replacement every time.

Deal with your Sangamo "Head-quarters."

Those who know ... choose Sangamo



SANGAMO ELECTRIC CO. MARION ILLINOIS

MAKE THIS YOUR HOME FOR IMPORTANT WORK UNDER IDEAL CONDITIONS!

- TEST & INSPECTION ENGINEERS • FIELD ENGINEERS
- ELECTRONIC ENGINEERS • LAB. TECHNICIANS
- TV RECEIVER DESIGN ENGINEERS

NEEDED TO WORK ON: YOU BENEFIT FROM high wages, a modern, air-conditioned plant, paid vacations and holidays, group insurance and a good chance for advancement. Housing immediately available in the beautiful suburban and country areas that surround the Bendix Radio plant.

Write, Phone or Wire Mr. E. O. COLE, Dept. O

Bendix Radio

DIVISION OF BENDIX AVIATION CORPORATION
BALTIMORE 4, MARYLAND



'SCOPES ARE "GOLD MINES"

... when you know how
to use them fully on all
types of service jobs

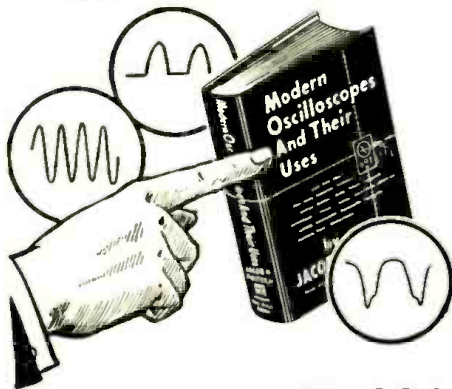

... AND THIS BOOK
MAKES IT EASY TO LEARN
ALL ABOUT THEM!

No question about it! The cathode ray oscilloscope is the handiest, most useful instrument in radio-TV servicing today. Servicemen who master it get the best jobs—make the most money—work lots faster—and are headed for even bigger things in the future!

MODERN OSCILLOSCOPES AND THEIR USES

By Jacob H. Rutter, Jr.
of Allen B. DuMont Laboratories, Inc.
326 pages. 370 illustrations. \$6.00

- ✓ When, where, why and exactly how to use them
- ✓ How to interpret patterns
- ✓ How to handle tough jobs easier and faster

Now the oscilloscope won't "stump" you—not when you have the clear explanations given by this famous book! It contains no involved mathematics—no puzzling and complicated discussions. Instead, it goes right to work explaining oscilloscopes fully and showing you exactly how to use them in lab work and on AM, FM and TV service work—from locating troubles to handling tough realignment jobs. Each operation is carefully explained including determining where and how to use the 'scope; making connections, adjusting circuit components, setting the controls and analyzing patterns fast and accurately. About 370 illustrations including pattern photos make things doubly clear.

No other type of specific service method training can mean so much to you in terms of efficiency and greater earning power! Send for it today. See for yourself how this book can help you—before you buy!

READ IT 10 DAYS ... at our risk!

Dept. RN-13 RINEHART BOOKS, Inc.,
Technical Division,
232 Madison Ave., New York 16, N.Y.

Send MODERN OSCILLOSCOPES AND THEIR USES for 10-DAY EXAMINATION. If I decide to keep the book, I will then remit \$6.00 plus a few cents postage in full payment. If not, I will return book postpaid and owe you nothing.

Name

Address

City, Zone, State

Employer's Name & Address

OUTSIDE U.S.A.—Price \$6.50 cash only.
Money back if book is returned in 10 days.

WHAT'S

New in Radio

For additional information on any of the items described herein, readers are asked to write direct to the manufacturer. By mentioning RADIO & TELEVISION NEWS, the page and the issue number, delay will be avoided.

RC OSCILLATORS

Hewlett-Packard Company, 395 Page Mill Road, Palo Alto, California, is currently introducing two new wide-range RC oscillators which are small in size and simple to operate.

The new instruments, Models 200AB



and 200CD, have high stability and quickly resettable tuning circuits. Operation is simplified and only three front panel controls are used. They are small in size, lightweight, and are mounted in an aluminum case with carrying strap for maximum portability.

The Model 200AB, for general audio tests, offers a frequency range of 20 cps to 40 kc. and a full watt output. The Model 200CD, for wide-range measurements at lower power levels, provides constant voltage output from 5 cps to 600 kc.

The company will supply additional details on request.

OIL-FILLED TUBULARS

A complete line of easy-mounting, single-stud tubular oil-filled condensers is now being offered by the Industrial Condenser Corp., 3243 N. California Ave., Chicago 18, Illinois.

The new units are oil-impregnated and filled with Indco Oil "A." Pyroteen filled units are also available. Standard capacity tolerance is +20% -10%. The temperature range with the Indco Oil is -40 degrees to +70 degrees C. and with Pyroteen -70 degrees to +90 degrees C. Power factor is .4% with the Indco Oil and .2% with Pyroteen.

A four-page illustrated catalogue, containing complete data on the new G and H types, is now available from the company.

PUSH-BUTTON SWITCH

Grayhill, 4524 West Madison Street, Chicago 24, Illinois, has developed a new push-button switch which meas-

ures only 1.047 inches from the end of the plunger to the end of the terminal tips. It is 1/2" in diameter at the widest point.

Designated as the Catalogue No. 23-1, the new switch is normally open and has a s.p.s.t. momentary contact arrangement. It is rated at 1/4 amp., 117 volts, noninductive. The bushing, providing single hole panel mounting, has a 5/16-32 thread.

Complete information on this new push-button switch is available from the company. Address letters to Mr. B. Doran.

FASTENING GUN

Of interest to service technicians is the newly-developed, hand-held automatic fastening gun which has been introduced by The Heller Stapler Company, 2153-E Superior Avenue, Cleveland 14, Ohio.

This compact unit is operated by just one hand, leaving the other hand free to guide the cable or hollow tube lines being installed. The force of the machine will drive bands around cables and tubes into hard or soft woods, plaster walls, flooring, joists,

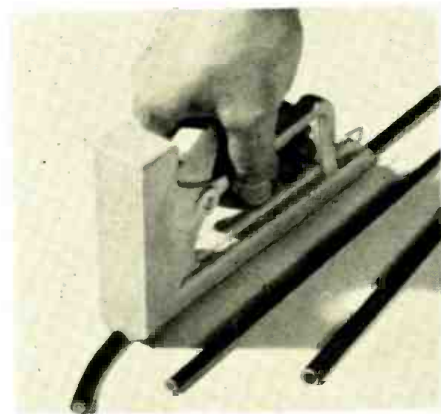

and even mortar joints and cinder or mineralite building blocks.

An extra-size band, with leg lengths varying from 3/16" to 1/2", is used with the new fastening gun.

BASS REFLEX CABINET

Argos Products Co., 310 Main Street, Genoa, Illinois, is now offering a new bass reflex cabinet to the trade.

Featuring a solid mahogany front and matching leatherette top and sides, the new cabinet has a single grille cloth covering the entire front panel, thus concealing the two separate sound openings and giving a more modern appearance.

Known as the "Deluxe Model DBR-15," the new cabinet is designed to accommodate either a 12" or 15" speak-

RADIO & TELEVISION NEWS

Flying Saucers?

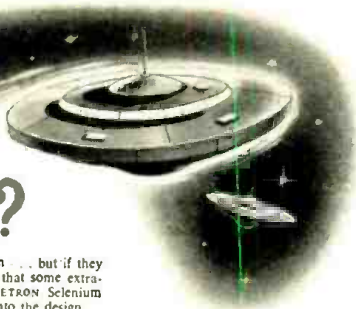

Frankly we don't know if they're fact or fiction... but if they are fact it wouldn't surprise us a bit to learn that some extra-terrestrial manufacturer has incorporated SELETRON Selenium Rectifiers and R. R. Co. Germanium Diodes into the design.

That's because—as pioneers in the field of electronic development—we've had our hand in some of the most difficult projects and met some of the stiffest requirements ever worked up! Making drawing board dreams come true are daily chores at Radio Receptor Co.!

GERMANIUM DIODES

Radio Receptor's new Germanium Diodes feature polarity at a glance combined with simplicity of construction and sound design principles. The tapered shape speeds assembly because operators can see at a glance the correct direction of assembly. Users are enthusiastic over the quality of the product which is currently being used in walkie-talkies, computers, TV sets, tuners and other electronic applications.

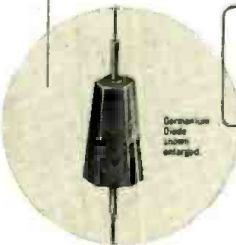

Germanium Diode shown enlarged.

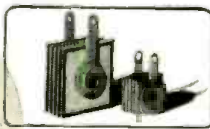

Our Germanium Diodes and Seletron Selenium Rectifiers may hold the answer to many of your problems. Radio Receptor Engineers will be glad to study your requirements and submit their recommendations on both of these products.

Germanium Transistors available in limited quantities.



SELENIUM RECTIFIERS

Seletron Selenium Rectifiers, in both miniature and industrial types, are in constant demand by an increasingly large number of engineers throughout the world because they are completely dependable under the most grueling conditions. Years of experience have given Radio Receptor Co. a deep insight into the idiosyncrasies of rectification.

Seletron and Germanium Division

RADIO RECEPTOR COMPANY, INC.

Since 1922 in Radio and Electronics
SALES DEPT.: 251 West 19th Street, New York 11, N. Y. • FACTORY: 84 North 9th Street, Brooklyn 11, N. Y.

IT'S A SHAME

to throw away that beautiful old Console... replace the obsolete radio with a modern, easily-installed

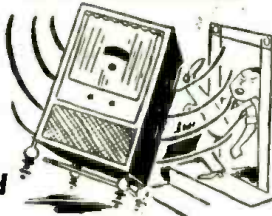

ESPEY AM/FM CHASSIS

(Enjoy Hi-Fidelity Reception)



It is not necessary to spend a large sum of money to modernize your old radio or to become a "High Fidelity" enthusiast. ESPEY chassis provide the Highest Quality at moderate prices.

Fully licensed under RCA and Hazeltine patents. The photo shows the Espey Model 511-C, supplied ready to play. Equipped with tubes, antenna, speaker, and all necessary hardware for mounting. **NEW FEATURES**—Improved Frequency modulation circuit, drift compensated • 12 tubes plus rectifier, and pre-amplifier 12AT7 tubes • 4 dual purpose tubes • High quality AM-FM reception • Push-pull beam power audio output 10 watts • Switch for easy changing to crystal or variable reluctance pick-ups • Multi-tap audio output transformer supplying 3.2—8—500 ohms.

Write Dept. RN-1 for literature and complete specifications on Model 511-C and others.

ESPEY Makers of fine radios since 1928
TEL. TRofelger 9-7000
MANUFACTURING COMPANY, INC.
520 EAST 72nd STREET, NEW YORK 21, N. Y.

Compare... prove EMC superiority



model 102

(1000 ohms per volt meter) • 3" SQUARE METER • 3 AC CURRENT RANGES (0-30/150/600 ma.) • Same zero adjustment for both resistance ranges 0-1000 ohms, 0-1 megohms) • 5 DC & 5 AC Voltage Ranges to 3,000 volts • Also 4 DC Current Ranges **\$14.90**



model 103

(1000 ohms per volt meter) • 4 1/2" SQUARE METER • 3 AC CURRENT RANGES (0-30/150/600 ma.) • Same zero adjustment for both resistance ranges (0-1000 ohms, 0-1 megohms) • Same Ranges as Model 102 • Also 5 DB Ranges **\$18.75**
Model 103-S with plastic carrying strap..... **\$19.25**



model 104

(20,000 ohms per volt meter) • 4 1/2" SQUARE METER (50 microamperes-Alnico magnet) • Includes carrying strap • 5 DC Voltage Ranges at 20,000 ohms volt to 3,000 V.; 5 AC Voltage Ranges to 3,000 V. • 3 Resistance Ranges to 20 megs • Also 3 AC & DC Current Ranges • 5 DB Ranges **\$26.95**
HVT 30,000 Volt Probe for Model 104 **\$7.95**

— See them at your Jobbers —

EMC

Write Dept. RN-1 for Free Complete Catalogue of these and other Instruments.

ELECTRONIC MEASUREMENTS CORPORATION
280 LAFAYETTE STREET • NEW YORK 12, N. Y.

EXPORT DEPARTMENT 136 LIBERTY STREET, N. Y. C. 6, N. Y.

NEW! 2ND EDITION of the only complete reference on AUDIO!

"The Recording & Reproduction of SOUND"

by OLIVER READ



Completely revised and vastly enlarged new edition

OVER
800
PAGES

A "Must" for
Sound Engineers, Hi-Fi
Enthusiasts, P. A.
Men, Broadcasting
Stations, Recording
Studios, Students

largest selling
book in its field

CONTENTS:

A Partial List of Authoritative Chapters:

Behavior of Sound Waves; Basic Recording Methods; Lateral Disc Recording; Microgroove Recording; The Decibel; Phono Reproducers; Stylis; Microphones; Loudspeakers and Enclosures; Dividing Networks and Filters; Attenuators and Mixers; Home Music Systems; P.A. Systems; Amplifiers; AM and FM Tuners—PLUS HUNDREDS OF OTHER SUBJECTS

Now you can have all the *right* answers to *any* subject in the field of Audio. Learn how to select and get the most out of recording equipment. Tells you how to select the proper amplifier for given applications, how to test amplifier performance, how to eliminate hum. Explains microphone, speaker and pickup principles and selection factors. Shows how to utilize inverse feed-back, expanders and compressors. Covers hundreds of subjects—a vast wealth of reliable information found in no other single volume. If you work in the field of Audio, this book belongs in your library. Order your copy today!

6" x 9" **ONLY \$7.95**
Hard Covers
800 pages 700 illustrations

**ORDER
TODAY**

Order from your Parts
Jobber, or write direct to
HOWARD W. SAMS & CO., INC.
2203 E. 46th St., Indianapolis 5, Ind.

My (check) (money order) for \$.....
is enclosed.

Send copy(ies) of *The Recording &
Reproduction of Sound (RR-2)*. \$7.95 per copy.

Name.....

Address.....

City..... State.....

er. The cabinet measures 23 $\frac{3}{8}$ " wide, 30" high, and 14 $\frac{3}{8}$ " deep. It is available in either blonde or mahogany finishes. All the necessary mounting hardware is included, along with a mounting board for 12" speakers.

A data sheet on these new bass reflex cabinets is available from the company on request.

FM TUNER

Browning Laboratories, Inc., of Winchester, Mass., has recently introduced a new FM tuner which has been designated as the Model RV-31.

The new tuner features an all-triode r.f. section and follows the *Armstrong* receiving method with dual cascade limiters for most effective noise quieting. Input signals of 3 microvolts will

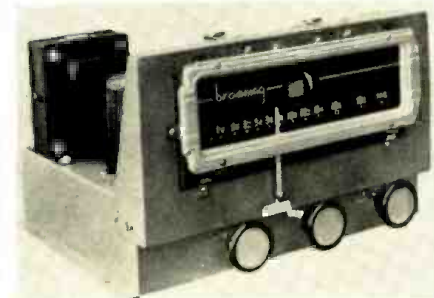

produce 20 db of quieting. An a.f.c. circuit locks the local oscillator into correct tuning but may be switched off if desired. A selector switch permits FM, phono, TV, or recorder playback to be fed through the tuner volume control to the main amplifier.

The RV-31 is suitable for custom installations where space is limited since it measures 11" wide, 9 $\frac{3}{8}$ " deep, and 6 $\frac{1}{2}$ " high. Knobs and dial escutcheon are furnished in black and silver to complement the black dial background.

EXTENSION SPEAKER

Auto radio sales and service technicians will be interested in a recent announcement from *Lowell Manufacturing Company*, 3030 LaClede Station Road, St. Louis, Missouri that it is now in production on an easily-installed rear-seat auto extension speaker baffle kit.

This "extra profit" item comes complete. It includes a 9" x 7" stamped metal louvre plate with tamperproof screening, a three-way switch, screws for mounting dial plate to car dashboard, complete mounting hardware, and detailed instructions.

The company will supply additional details on request.

VARNISH REMOVER

A non-inflammable, impregnating varnish remover that rapidly strips all types of impregnating varnish from baskets, jigs, etc. has been announced by *London Chemical Company*, 325 W. 32nd Street, Chicago 16, Illinois.

The new "Lonco" remover is designed for fast stripping, at room temperature, of all types of varnishes used in the electrical field. The only equipment necessary is a covered tank large

G. E. RELAYS*



CR2792B116A3
SPST—50 Amp Contacts. Operates from 22-30 VDC. Coil Res. 200 Ohms. Completely enclosed in transparent plastic case, which may be removed for adjustments..... **\$1.59**

GE#CR2791B116W3

Same as above, except additional terminal brought out from contact arm..... **\$1.74**

GE#CR2791-F100D3

Differential: DPST. Norm. open. Dual coil, 1500 ohms per coil—25 Ma. Operating Current. **\$2.25**



GE#CR2791F100G3

Same as above, except has extra 1A contact. Rated 5 Amp..... **\$2.35**

GE#CR2791D101F3

All Ceramic Insulation. DPDT. Coil 12VDC. 100 Ohms DCR. Contacts designed for fast operation. Rated at 5 Amps..... **\$1.25**



GE#CR2791B106J3

3PDT. 5 Amp contacts. Coil rated 22-30VDC. 150 Ohms DCR. Contacts are designed for fast operation, and enclosed by clear plastic cover. **\$1.35**



GE#CR2791B106C3

SPDT. Dual Contacts will handle 20 Amps. Coil: 18-28VDC 125 Ohms DCR..... **\$1.25**



THESE RELAYS AVAILABLE* IN MFRS. QUANTITIES

DYNAMOTORS

Type	Input Volts Amps	Output Volts Amps	Radio Set
PE85	28 1.25	250 .060	RC 36
DM416	14 6.2	330 .170	RU 19
DM33A	28 7	540 .250	BC 456
PE101C	13/26 12.6 6.3	400 .135 800 .020	SCR 515
BD AR 93	28 3.25	375 .150	
23350	27 1.75	285 .075	APN-1
ZA0515	12/24 4/2	500 .050	
B-19 pack	12 9.4	275 .110 500 .050	MARK 11
D-104	12	225 .100 440 .200	
DA-3A	28 10	300 .060 150 .030	SCR 522
		14.5 .5	
5053	28 1.4	250 .060	APN-1
PE73CM	28 19	1000 .350	BC 375
CW21AAX	13 12.6	400 .135	
	26 6.3	80 .020 9 1.12	
PE94	28 10	300 .200 150 .101 14.5 .5	SCR 522

RECTIFIER TRANSFORMERS

Pri: 115V. 60 Cy. Sec: 28V/3.1A. 26V/8.4A
7.3V/14A..... **\$12.95**
Pri: 210/215/220 225 235/235 240V. 60 Cy. I
Phase. Sec: 11/10/7.5/5VCT @ 35A..... **19.50**
Pri: 115V 60 Cy. Sec: 20V @ 10A..... **3.95**
Pri: 115V 60 Cy. Sec: 8.1 V @ 1.5A..... **1.39**

FILTER CHOKES

Stock	Description	Price
CH-366	20H/3A.....	\$ 6.95
CH-322	.35H/350 MA—10 Ohms DCR.....	2.75
CH-141	Dual 7H/75 MA.....	4.69
	5KV DC Test.....	2.79
CH-119	8.5H/125 MA.....	2.35
CH-69-1	Dual: 120H/17 MA.....	1.79
CH-8-28	2 x .5H/380 MA/25 Ohms.....	2.25
CH-276	1.28H/130 MA/75 ohms.....	2.35
CH-343	1.5H/145 MA/1200V Test.....	1.75
CH-43A	104H/15 MA—850 ohms DCR.....	12.95
CH-917	10H. 450 MA. 10KV TEST.....	69.55
CH-366	20H 300 MA.....	1.95
CH-999	15HY 15 MA—400 ohms DCR.....	2.45
CH-511	6H 80 MA—310 ohms DCR.....	2.79
CH-3-50	2x5H/400 MA.....	1.79
CH-188M	5HY 200 MA.....	1.79
CH-303	300H/02A. 2500V Test.....	7.95
CH-932	SWING 9-60H/4-.05A. 10KV.....	7.95

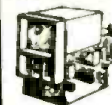

BC 605 INTERCOM

Easily converted to an ideal inter-communications set for office, home, or factory. Original. New w/conversion. Diagram..... **\$4.75**

Send M.O. or Check. Shipping Chgs. C.O.D.
COMMUNICATIONS EQUIPMENT CO.
131 Liberty St. Dept. N-1, New York City 7, N. Y.

enough to accommodate the piece to be stripped.

Attack on the coating begins immediately and parts are normally stripped clean in 1/2 to 4 hours. Overnight immersion will remove heavy coats up to 3" in thickness.

Further information and a free sample are available from the company.

TAPE RECORDER

Allied Radio Corporation, 833 W. Jackson Boulevard, Chicago 7, Illinois is currently offering a low-priced tape recorder which incorporates many new features for a variety of applications.

The "Knight" 96-485 has "automatic keyboard" control. Five piano-key type push-buttons permit the quick and easy selection of the operating functions including "fast forward," "play-back," "stop," "record," and "fast reverse." The "fast forward" speed enables the user to locate that portion of the recorded tape desired for play-back.

Two speeds and a dual-track recording head provide four recording times. At the speed of 3.75" per second, a 7" (1200 foot) reel records continuously for one hour, or two hours by recording on the second half of the tape width. At the 7.5" speed, the recording times are one-half hour continuously and one hour over-all. Frequency response is flat from 70 to 8500 cps at 7.5" and 90 to 6000 cps at 3.75".

The unit is housed in a sturdy, two-tone green, luggage-type case which measures 14" x 12" x 7". It weighs less than 22 pounds. Ready for operation



from any 105-120 volt, 60-cycle a.c. outlet, the unit comes complete with crystal microphone. 8 feet of mike cable, a 600-foot reel of type "A" tape, a 5" take-up reel, and all tubes.

HAM XMTR. KIT

E. F. Johnson Company of Waseca, Minnesota, is now in production on a new ham transmitter kit known as the "Viking II".

Rated at 130 watts c.w. output, 100 watts phone, the new transmitter has been designed for operation on every amateur band from 10 to 160 meters, including the recently-assigned 15-meter band. The pi-network amplifier matches a wide variety of antenna impedances. A crystal selector assem-

January, 1953

M I R R O S C O P E

MODEL 476

Simpson

Advanced design in oscilloscopes. Vertically mounted 5" cathode ray tube is reflected in the adjustable mirror. Mirroscope can be used by technician seated or standing merely by adjusting mirror angle—not necessary to move the instrument.

A quality instrument with tomorrow's features.—Dealer's net price, \$179.50

Optically surfaced mirror gives distortion free image of cathode ray tube

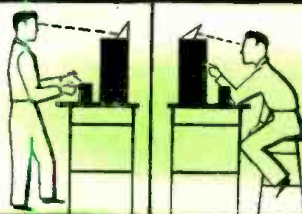

Ask your jobber for full information or write

Simpson Electric Company
5200 West Kinzie Street
Chicago 44, Illinois
CO 1-1221

Another reason why Simpson is the world's largest manufacturer of test equipment.

BURTON BROWNE ADVERTISING



GET in on the fun of operating your own licensed transmitter. I guarantee you will memorize the International Morse Code alphabet within two hours by my simple picture method, or return method within five days and I will refund your money.

COMPLETE COURSE ONLY \$1
NOTHING ELSE TO BUY!
OTTO LUTHER, NEW PRESTON, CONN.



RADIO SERVICEMEN!
Write for SENSATIONAL CATALOG
HENSHAW RADIO SUPPLY
3619 TROOST KANSAS CITY, MO.



Vertical design of microscope gives larger control panel area—better spacing of controls for easy adjustment. All connections made in front.

MODEL 276 OSCILLOSCOPE CALIBRATOR



To take full advantage of your microscope—Model 276 Oscilloscope Calibrator. Accurate voltage readings of the oscilloscope wave forms. For use with any oscilloscope. Dealer's net price \$29.50.

This much space ordinarily required

Base is only 9" x 8"

Base dimension or bench area only 9" x 8"—less than half of the bench area used by old style oscilloscopes—you gain valuable working space with the microscope.

You save this bench space

Unlimited Opportunities in RADIO ENGINEERING

DEGREE IN 27 MONTHS

Complete Radio Engineering course, including Telev., U.H.F. and E.M. Bachelor of Science Degree also in Mech., Civil, Elect., Chem., and Aero. Eng.; Bus. Adm., Acct. Extensive campus, modern buildings, well equipped labs. Low cost. Prep courses. Personalized, practical instruction. Founded 1881. Placement service. Growing shortage of engineers. Prepare now for unlimited opportunities ahead. Approved for Korean vets. Enter January, March, June, September. Write for catalog.



TRI-STATE COLLEGE

1613 College Avenue, ANGOLA, INDIANA

DEPEND ON CONCORD

For OUTSTANDING VALUES!

STANDARD BRANDS—NEW—GUARANTEED

TUBES 60% OFF LIST!

TYPE	LIST	YOUR COST	TYPE	LIST	YOUR COST
1B3	\$2.55	\$1.02	6AL5	\$1.80	\$.72
1R5	2.10	.80	6AU6	1.80	.72
1T4	2.10	.84	6BG6G	4.80	1.92
1U4	2.10	.84	6AQ5	2.00	.80
3V4	2.00	.80	6SN7GT	2.20	.88
5U4GT	1.50	.60	6V6GT	2.00	.80
5Y3GT	1.10	.44	12AU7	2.40	.96
6AG5	2.25	.90	12AT7	2.90	1.16

60% off on all other Receiving Tubes.



NATIONAL TURRET BOOSTER

Finest turret tuner ever designed. Built-in Power supply. Brand New! Lots of 6
ea. **\$10.00**
Lots of 3.....**\$10.95 ea.**
Singly **11.95**

VM 2-SPEED RECORD CHANGER

With automatic changer and shut-off. 33 1/3 and 78 RPM. Positive intervals of 10", 12" records. Jam-proof!
\$18.95



10 Element Conicals

Superb low-priced "all aluminum signal getter."



\$3.15 ea.

Lots of 6—**\$3.95 ea.**
Single lots

"V" ANTENNAS

Factory assembled for top electrical and mechanical performance.

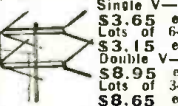

Single V—**\$3.65** ea.
Lots of 6—**\$3.15** ea.
Double V—**\$8.95** ea.
Lots of 3—**\$8.65** ea.

INTERLOCK TV LINE CORD

6 ft. line cord—for all popular TV sets.
27c



3 1/2" STANDOFF

Fully adjustable, easy to mount.



50 for... **\$3.95**

LIGHTNING ARRESTOR

For Twin lead or open transmission line. Mounts flat or on mast. **1.25** List.
63c



3 1/2" SCREWEYE

Insulated stand-off. High quality. Low price.
\$2.75
100 for ...



MAGNIFICENT BRITISH HI FIDELITY 5" PM SPEAKERS

A sensational value! 50—12,000 CPS range. Outperforms most 8" and 10" units. Highly efficient for general use in amplifiers, radios, TV sets and stereo combinations. 4.8 ohm impedance—1.5 oz. Alnico magnet. Buy now while we still have stock on hand!
Stock No. 99-A-850P. Singly **\$1.69** EACH **\$1.59**
In lots of 4—

1/2 MEG VOLUME CONTROL with SWITCH **29c**
Singly 33c, Lots of 6..... ea.
300 OHM TWIN LEAD. 100 ft. **\$1.39**
1,000 ft. **\$10.95**

ALL C.O.D.'s 25% DEPOSIT
MINIMUM ORDERS: \$5.00

CONCORD RADIO

53-L Vesey Street, New York 7, N. Y.

Phone: Dlgby 9-1132

OPEN WEDNESDAYS UNTIL 9 O'CLOCK

CONCORD RADIO, 53-L Vesey Street, N. Y. 7 Dept. N1

Please include my name on your Special Bargain Mailing List. Free of charge.

Name

Address

City State

bly permits the selection of any one of 10 crystal frequencies from the front panel, with an 11th position provided for use with an external v.f.o.

All stages are metered and dual power supplies are designed for econ-



omy and operating convenience. For novice operation, the final amplifier input may be reduced to 75 watts without transmitter modification.

The transmitter, TVI suppressed, is enclosed in a heavily copper-plated steel cabinet. The lid is bonded with silver-plated, phosphor bronze contact fingers. Special shields are included for the meter, dial window, and v.f.o. power socket.

A free bulletin, No. 714, giving complete specifications on the new transmitter kit, is available on request.

COMPACT CONVERTER

The Terado Company, 1068 Raymond Ave., Saint Paul 8, Minnesota has introduced a compact d.c. to a.c. converter, the "Trav-Electric Super," Model No. 6-71160.

This unit converts 6 volts d.c. (car battery) to 110 volts, 60 cycle a.c. Capacity is 60 watts continuous and 75 watts intermittent. Suggested uses for the new unit include the operation of wire recorders, dictating machines, portable phonographs, radio receivers, small electric drills, hand vacuum cleaners, electric shavers, lights, and test equipment.

A catalogue sheet describing this and other converters in the company's line is available on request.

SOLDERING MACHINE

Sunrise Products Company, P. O. Box 173, Hawthorne, New Jersey, is currently featuring a new soldering unit, the Model XK-72.

This compactly-designed resistance soldering unit incorporates a sensitive interval timer (1/5 to 90 seconds) and an adjustable heat controller to per-



mit fast, precision soldering without overheating or warping of the parts to be soldered.

The electrode holder, L-14, measures 6" long and weighs just 3 1/2 ounces.

Trav-Electric

\$15.95 LIST

Model 6-1160

MIGHTY MIDGET CONVERTER

Just plug into
Cigar Lighter on Dash

Converts 6 volts D.C. to 110 volts A.C. 60 cycles 40 watts.



PORTABLE PHONOGRAPH



IN THE CAR—IN THE TRUCK



DICTATING MACHINE



ELECTRIC SHAVER



IN BOATS



AT PICNICS—OUTINGS

Ideal for phonographs and turntables at beach, or picnic.

Radios, short wave or broadcast bands in car, truck and cabin, etc.

Small dictating machines... ideal for salesmen, business or professional men.

Electric shaver works beautifully when it is plugged into Trav-Electric. A great time saver.

Boats—the 110 volts A.C. operates radios, lights, etc.

Ideal for outdoor musical entertainment from table radio to phonographs, including most wire and disc recorders.

Fully Guaranteed

THOUSANDS IN USE
See your Electronic Dealer or Jobber, or write direct



Model 6-1160

Size 2 1/2" x 2 1/2" x 3 1/2"

TERADO Company

Mfrs. of Precision Equipment

1068 Raymond Ave., St. Paul 14, Minn.
In Canada, write: Atlas Radio Corp., Ltd., 560 King Street West, Toronto 28, Canada

Three tips, 1/8", 1/4", and 5/16" diameter, are available for use with this unit.

A brochure describing the Model XK-72 and other units in the company's line is available without charge upon request.

H.V. TEST JACK

Alden Products Company, 117 North Main Street, Brockton, Massachusetts has introduced a new, skirted test point jack, the 110BCSH, which permits safe circuit voltage readings up to 3000 volts a.c. peak from the front of equipment panels.

Its high collar protects the operator from flashover during high voltage checks. Actual flashover breakdown-to-chassis occurs at 7-8000 volts a.c. (r.m.s.).

This new miniature test point jack has a beryllium copper contact, made to critical accuracy in progressive dies to insure resilient, long-life contact action. Its pre-tinned soldering tab is suitable for use with up to 14 gauge wire.

For complete information on this new product, address requests for additional data to Mr. Nelson Hearn at the company's address.

AUTOFORMER

Halldorson Transformer Company, 4500 Ravenswood Avenue, Chicago 40, Illinois, has announced the availability of a new "Varivolt Autoformer" which permits the adjustment of line voltages of 65, 75, 90, 100, 115, 130 and 145 volts to 115 volts, or to other voltage levels within the unit's range.

Voltage is set by means of a seven-



step rotary switch and indicated by a voltmeter having a red-line marker at 115 on its 0-150 volt scale. Each unit is equipped with a conventional six-foot plug-in line cord and a standard output receptacle.

The line is currently available in four wattages (resistive load rating): 150, 350, 500, and 750.

UNIDIRECTIONAL MIKE

The Astatic Corporation, Conneaut, Ohio, has announced the addition of a unidirectional dynamic model to its line of microphones.

Known as the "Dynabar" Model DR-11, the new microphone employs the company's exclusive sintered metal method of acoustic phase shifting. This accomplishes a front-to-back

SENSATIONAL '53 STANDARD SURPLUS VALUES

NEW 12 VOLT BATTERIES
 For Mobile Or Light Airplanes. In original factory boxes. Weight: 37 Lbs. Size: 5 1/2" wide x 10" long x 10" high. Signal Corps Type BB-53. 12 Volt. 34 AH.
 A real terrific surplus value while they last. all new. **\$9.95 Ea.**

MIDGET SELSYNS
 A10 type operates from 6-12 Volts 60 Cycle. Use as both transmitter and receiver. These compact little units draw almost no current and work fine for all remote position indicating applications. OD 2 1/2 x 2 1/4 x 2". Has spring return shaft. All New (Appr. wt.).
 1 lb. Each **\$2.50**
 A-V-5 Type, same as above but has a continuous rotating shaft. These compact units are all new. **\$4.95**

WILLARD 2 VOLT RADIO BATTERY
 NEW. Uncharged (Appr. wt. 4 lbs.) TYPE 20-2. **\$2.50 Ea.**
 Complete set of three with box and connections to make a 6 volt, 20 Amp. hrs. Battery Uncharged **\$8.95** (Appr. wt. 15 lbs.) ... Set

2 VOLT VIBRATORS. V18A Synchronous Type. Used in all portable radios having 2 volt wet cell supply. All new. **\$1.00 Ea.**

PROP PITCH MOTORS
 For your Beam Antenna. 20 Volt to 32 Volt. A.C. or D.C. 1 1/2 H.P. Motor. 154 RPM Gear Reduction. 9000 to 1. ALL BRAND NEW. **\$16.95 Ea.**

12-24 VOLT TRANSFORMER
 Open frame type 0-12-24 Volts @ 2 Amps. 115 Volts. 60 Cy. Input. Limited Quantity. All New. **\$3.50 Ea.**

HI AMP. TRANSFORMER
 11 Volt 65 Amp. Output—115 Volt 60 Cy. Input. Ideal for welding or Heavy Fil. Tubes or Heat Treating. Approx. Wt. 50 Lbs. SPECIAL AT **\$15.95 Ea.**

SCR-283 RADIO SET
 Brand new—Consisting of 1-BC129 Receiver (similar to RU-18) and 1-RC130 Transmitter with Coils, and All Tubes, Dynamotor, Control Boxes, Mounting Brackets, Instruction Book, Antenna, Relay, etc. Less Cables. All New. **\$39.95 set**

DYNAMOTORS

TYPE	INPUT V.	OUTPUT V.	M.A.	PRICE
DM-10C	12	210	20	\$14.95
DM-34	12	220	80	8.95
DM-77	12	1000	350	29.95
PE-86	24	220	80	4.95
DM-106	24	220	80	4.95
DY-2	28	250	60	3.95
ARC-5	28	500	100	4.95
RU-16	28	330	135	6.95
	18	450	100	2.95

REVERSIBLE MOTOR
 1/40 H.P. Ball-bearing 3450 R.P.M. in Blast-proof case. Needs only a capacitor for starting. All Brand New. 110 V. 60 Cy. Special Low Price. **\$4.95** Starting Capacitor. **\$0.69 Ea.**

B-3A INTERVALMETERS
 This unit was used to release bomb loads at different time intervals and now can be used ideally for dark room timers, etc. Complete with ten 2050 tubes; four sensitive relays and other related parts. Excellent condition. **\$6.95 Ea.**

12 VOLT BLOWER MOTOR
 The famous Trade Winds Blower for use on Trucks, Boats, Etc. Ideal for Engine Room use as motor. Is completely enclosed and Sparkproof. 4" outlet. All Brand New. **\$9.95 Ea.**

ARC-4 TRANSCEIVER
 140-144 MC. Ideal for 2 meters. Complete with 20 tubes and control box. BRAND NEW. **\$29.95**

BC 357 MARKER BEACON
 75 Mc. uses 1-2AQ7, 1-12CB Tubes. Excellent condition. Less Tubes. **\$3.95** With Tubes. **5.95**

ARC 5 EQUIPMENT:

TRANSMITTERS
 3 to 4 MCS. **\$14.95**
 4 to 5.3 MCS. **8.95**
 5.3 to 7 MCS. **7.95**
 All above complete with all tubes and crystal. In excellent condition.

R-4-ARR-2 RECEIVER—234-258 MCS
 Complete with all tubes a B-3 dynamotor. Excellent condition. **\$19.95**

RECEIVERS
 190 to 550 KC **\$16.95**
 3 to 6 MCS. **9.95**
 6 to 9 MCS. **9.95**

All above Receivers complete with all tubes and dynamotor. In excellent condition.

COMPONENTS
 MOUNTING RACKS
 Single Trans. **\$1.00 Ea.**
 Double Trans. **1.75 Ea.**
 RE-2ARC-5 ANTENNA RELAY UNIT
 Comp. with Meter and 50 MMFD vac. cond. **\$4.50**
 MD-7 ARC-5-PUSH PULL MODULATOR UNIT
 Comp. w. tubes and dynamotor. Etc. **\$11.50**

MODEL 60-9 TRANSMITTER
 ONLY A FEW LEFT
 All brand New. 100 Watts CW, or MCW, emission. Operates from 110 V., 800 Cycle, easily converted to 60 Cycle operation. Low frequency range, 300 KC. to 600 KC. High frequency 3,000 KC. to 15,000 KC. using an E.C.O. We furnish complete conversion data with each transmitter. Complete with an E.C.O. schematics. **\$25.95**

DIAL TELEPHONES
 French type phone made by Kellogg. Can be used for standard extension phone. Used. **\$12.95 Ea.**
 With Dial **\$9.95 Ea.**
 Without Dial **\$9.95 Ea.**

TELEPHONE DIALS
 Standard Phone Dials ideal for use in any remote control relay circuits. **\$2.95 Ea.**

GYRO MOTOR UNITS
 Dual Gyro Unit which was used in conjunction with Auto-Pilot equip. Both Gyro Motors mounted on a single base, wired in parallel for 12 or 24 Volt operation. One used as the Azimuth control and the other as an elevation control. When ordering these Units, specify 12 or 24 Volt. Our price—Special. **\$4.95 Ea.**

SOUND POWER HANDSETS
 Use these phones without any external or internal voltage source. They can be used with only 2 wires interconnecting them. Use for TV installation, house to house or house to garage. All new. Per Pair **\$19.95**

SOUND POWERED HEAD AND CHEST SET
 Use same way as Hand Set except you have freedom of hands. No batteries or power source needed for operation. Excellent Condition. Per Pair **\$11.95**

HOBBY MOTORS
 Operates from 110 Volts. 60 Cy., AC. Two Types Geared Motors: Type A; 3 Speeds: 1,000 RPM., 1,500 RPM., 2,250 RPM. Type B; 3 Speeds: 1,000 RPM., 200 RPM., 5 RPM. These motors can be used for Bar-B-Que stoves, blenders or any low speed application. Each speed on a separate shaft. Can be used separately or at the same time. All New. **\$12.95 Ea.**

CAPACITORS • FIXED • OIL FILLED
 Solar, Pyralol, C.O., Etc.
ALL O.C. VOLTAGE RATINGS

2 MFD. 400 V.	1.95	2 MFD. 1000 V.	\$1.25
3X3 MFD. 400 V.	2.95	3 MFD. 1000 V.	3.95
10 MFD. 400 V.	2.95	10 MFD. 1000 V.	4.95
1 MFD. 600 V.	.75	1 MFD. 1500 V.	1.50
4 MFD. 600 V.	1.95	4 MFD. 2000 V.	2.25
5 MFD. 600 V.	1.95	6 MFD. 1500 V.	2.95
6 MFD. 600 V.	1.95	1 MFD. 2000 V.	1.95
8 MFD. 600 V.	1.95	2 MFD. 2000 V.	1.95
8X8 MFD. 600 V.	2.25	3 MFD. 2000 V.	3.50
10 MFD. 600 V.	2.95	4 MFD. 2000 V.	3.95
15 MFD. 600 V.	2.95	1 MFD. 3000 V.	3.95
20 MFD. 600 V.	2.95	4 MFD. 3000 V.	5.95
3 MFD. 1000 V.	1.00	1 MFD. 3000 V.	5.95

CAPACITORS TRANSMITTING VARIABLE
 K 1 MMFD. to 75 MMFD. 1/4" Spacing. **\$1.95**
 *D 12 MMFD. to 125 MMFD. 3000 V. Peak. **3.50**
 *E 28 MMFD. to 110 MMFD. 5000 V. Peak. **3.95**
 *F 12 MMFD. to 150 MMFD. 3000 V. Peak. **3.50**
 *G 7 MMFD. to 80 MMFD. 1500 V. Peak. **1.00**
 *H With National "Vee-Vent" Vernier Dial. All New Hammerhead, Gardwell, Etc.

ARMY AMMUNITION CANS
 Type M-3 50 Cal. Cans 12" Long x 6" Wide x 7 1/2" Deep.
 Type M-1 Cans 16 1/2" Long x 3 1/2" Wide x 8 1/2" Deep.
 All aluminum with Leather Handle and Hinged Top with hasp. Use for all your small parts or tools. O.D. Color, clean. Each **\$1.50**

MICA CAPACITORS

CAP.	W. VOLTS	PRICE
.003	500	\$1.50
.005	1000	1.00
.015	3000	2.50
.03	3500	1.25
.05	5000	1.50
.00015	5000	1.95
.0002	5000	1.75
.0003	5000	2.25
.000375	5000	2.50
.0005	5000	3.00
.0005	5000	2.75
.0005	5000	3.25
.00072	5000	3.35
.00075	5000	2.75
.0008	5000	3.25
.001	5000	3.25
.0011	5000	2.95
.0015	5000	3.25
.002	5000	3.25
.004	5000	3.50
.005	5000	3.75
.006	5000	3.50
.001	6000	3.50
.0001	7500	2.95
.001	7500	3.95
.00015	600	.35
.01	1200	.75
.001	1200	.65
.005	5000	3.50
.01	2500	1.50
.002	2500	1.00
.0005	2500	.75
.00025	2500	.65
.00005	2500	.75

COAXIAL CABLE
 52 OHM Transmission Cable. Made to J.A.N. Specification. Same as RG-5U. All unshielded. On Reels of approximately 1,000 FT.
 100 Ft. **7c per Ft.**
 1,000 Ft. **5c per Ft.**
 10,000 Ft. **5c per Ft.**
 RG-7U-95 OHM Coaxial Cable **6c per Ft.**

All Mail Orders Promptly Filled, F.O.B., San Francisco. All California Orders—Add 3% Sales Tax. Do not send postage stamps. Write for our 1953 free booklet listing our stock and prices on Radio, Electronics, Tools, Hardware, Motors, Wire, Meters, Batteries, Aluminum Sheets, etc. 20% Dep. on all C.O.D. orders. All items subject to prior sale and prices subject to change without notice. On Purchases under \$5.00, send full amount.

STANDARD SURPLUS 1230 Market St., San Francisco 3, Cal. Telephone HEMlock 1-3106

THE Original

WRENCH WITH THE SCREWDRIVER ACTION!

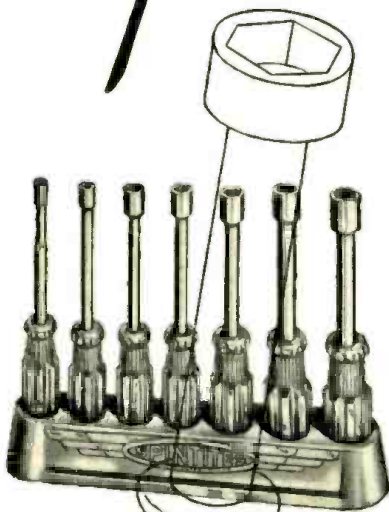

SPINTITE
REG. U. S. PAT. OFFICE

120 STYLES and SIZES

for

- ASSEMBLY WORK
- REPAIR WORK
- RADIO
- TELEVISION
- INDUSTRIAL
- AIRCRAFT



STEVENS WALDEN, Inc.
WORCESTER 4, MASS.

pickup differential of approximately 15 db, which makes the microphone, for all practical purposes, dead to extraneous noise and drone, according to the company.

The internal dynamic element is floated in rubber to help insure stability. An impedance selector switch provides operating impedance of 50, 200, 500, and high impedance. The switch is located at the back of the microphone housing, flush with the surrounding grillework to prevent accidental turning. It has a center slot for easy turning with coin edge or screwdriver.

Output level is -54 db (1 volt-per-microbar) and the range is 40 to 10,000 cps. Standard equipment includes an *Amphenol* cable connector and 18 feet of two-conductor shielded cable.

PROGRAM EQUALIZER

Production on a new program equalizer, the Type 4031-B, has started at the Burbank, California plant of *Cinema Engineering Co.*

The new instrument has wide applications in sound and electronic laboratories for research and control; broadcasting, recording, and motion picture



uses include providing corrections for frequency response in audio equipment, sound pickup, and transmission lines.

Easy operation of two control knobs allows wide range of over 395 available curve combinations. Controls provide for independent adjustment of the high and low frequencies in 2 db steps. Input level minimum is -70 dbm and maximum +20 dbm.

The equalizer uses standard RTMA rack mounting and is available either from the company's New York representative, *Audio & Video Products*, 730 Fifth Avenue, or from the manufacturer direct.

RCA SHOWS EXPERIMENTAL TRANSISTOR GEAR

RCA recently demonstrated a series of electronic gear in which a wide range of transistor applications useful to radio, television, and the industry were incorporated.

Each development was in the form of a laboratory model which, it was emphasized, is still in the preliminary and experimental stage. None of the units is commercially available at the present time.

Among the equipment demonstrated at the David Sarnoff Research Center of RCA in Princeton, N. J., was a portable public address system, a personal radio which was transistorized except for one tube, an all-transistor personal radio, a portable FM receiver, a transistor portable phonograph, a wireless phono jack, a roving microphone, a toy piano, a transistor ukelele, and a portable television receiver.

Ten types of RCA developmental and experimental transistors, three of the point-contact variety and seven of the junction transistor family, were used in the equipment. The three point-contact types and one of the junction types are to be offered on a limited sampling basis for engineering advanced development to industry representatives. The other six junction-type transistors are still classed as experimental.

Among the experimental items which attracted considerable attention was a portable, battery-operated television receiver, tubeless except for the picture tube. In another approach transistors were introduced in part of the circuits of a standard television receiver. Transistors were also employed in circuits of industrial TV equipment and the "Walkie-Lookie" portable TV camera equipment to point up savings in weight, size, etc.

In summarizing the demonstration, Dr. E. W. Engstrom, vice-president in charge of RCA Laboratories Division, said:

"These demonstrations highlight the fact that transistors are today no longer entirely a research concern. They are,

in the fields of radio and television, an immediate problem for advanced development by industry engineers who can learn how to put them to work in evolving more versatile, smaller, sturdier, and eventually lower cost equipment for industry and the public."

D. D. Holmes, staff member of the David Sarnoff Research Center of RCA at Princeton, N. J., demonstrates the simple replacement of a junction-type transistor in an auto receiver operating solely from 11 developmental and experimental transistors instead of the customary electron tubes. The use of transistors makes it possible to eliminate the usual high-voltage power supply. The transistors operate directly from the car's 6-volt storage battery so that the receiver has only 10 per cent of the usual drain on the automobile battery.



Audio Oscillator

(Continued from page 64)

power supply shown be adopted as all parts are standard and the over-all cost is low.

The theory of tuned RC nets has too many ramifications to be discussed here; those interested are referred to the bibliography at the end of this article. However, a brief description of oscillatory action in this circuit will be given. As stated before, the circuit is essentially a two-stage RC-coupled amplifier, with the output of the second stage brought back to the input of the first. There are three necessary components for oscillation: a gain-producing element, a phase-controlling element, and a frequency-selective element. The two-stage amplifier represents the gain-producing element. However, the output is fed back negatively through the lamp in the cathode circuit of the first stage, which limits the gain of the amplifier to slightly more than three times. Simultaneously, positive feedback is coupled through the RC net to the grid. This net is frequency selective due to its transfer-phase shift characteristic. At some frequency, depending upon the values of R and C, the voltage at the grid will be in-phase with the voltage impressed across the entire net and equal to 1/3 of the impressed voltage. At any other frequency, for the same RC values, the grid voltage will either lead or lag the impressed voltage by some angle. Thus for only one frequency will the second stage output and the first stage input be in phase. At this frequency the grid and cathode voltage are in phase, and the negative feedback voltage developed across the lamp must be just slightly less than the voltage developed between grid and ground, i.e., a slight net positive signal, for oscillation to occur at this frequency. At all other frequencies the negative feedback voltage is greater than the positive feedback voltage; hence oscillation will occur at one and only one frequency.

Although single-frequency oscillation is assured with sufficient positive feedback, good waveform is not. It is with the greatest of ease that this circuit can and will produce almost any desired waveform. Continuous sine waves are only one of a great variety, and are the result of critical damping, to borrow a mathematical term. Over-damping produces a damped wave train, usually sinusoidal in form; under-damping is multivibrator action. For continuous sine waves, the negative feedback must be adjusted so that an over-all gain of unity results. This is the condition where the energy fed back positively just cancels the circuit losses. While it is relatively easy to make this adjustment for one frequency, to do so for a wide range of frequencies requires another variable element.

RADAR COMMUNICATIONS—TEST EQUIPMENT

- AN-ARC-1—Transceiver 100-156 MCS
- APN-1—Pulse Analyzer
- ARC-1—Airborne Radio Altimeter
- ARC-4—VHF Transceiver 140-180 MC
- ARN-5—Glide Path Receiver, \$69.50
- ARN-7—Airborne Direction Finder
- ARR-2—Homing & Receiving Equipment
- BC-223—30-Watt Transmitter 2-5.2 MC
- BC-342—Receiver—1.5 to 18 MC 110v AC
- BC-348—Receiver—1.5 to 18 MC 28v DC
- BC-375E—Radio Transmitter
- BC-640—VHF Receiver 100-156 MC, \$400.00
- BC-640—VHF Transmitter 140-156 MC
- BC-1206—Beacon Receiver 200-400 KC
- RC-103—Airborne Localizer Receiver
- SCR-269—Radio Compass, \$129.50
- SCR-274N—Command Equipment
- SCR-284—Field Radio Station, \$365.00
- SCR-291—Semi-Portable Direction Finder
- SCR-300—Field Transmitter and Receiver
- SCR-522—VHF Transmitter and Receiver, \$129.50
- SCR-536—Handi-Talkie
- SCR-555—Semi-Portable Direction Finder
- SCR-694—Portable Field Transceiver
- SCR-718A-AM-C—High Altitude Altimeter
- T-50—Radio Telegraph Transmitter

- TS-3 AP—S-Band Power Frequency Meter
- TS-10/AP—APN-1 Test Set, \$25.00
- TS-12/AP—X-Band V.S.W.R. Test Set
- TS-13/AP—X-Band Signal Generator
- TS-14/AP—X-Band Signal Generator
- TS-15/AP—Flux Meter
- TS-18/AP—APN-1 Test Set, \$29.95
- TS-18/AP—Capacity Test Set
- TS-23/APN—SCR-718 Test Set
- TS-33/AP—X-Band Frequency Meter
- TS-44/AP—Synthesizer, complete with accessories, \$290.00
- TS-35/AP—X-Band Test Set
- TS-36/AP—X-Band Power Meter, \$140.00
- TS-45/APM-3—X-Band Signal Generator
- TS-59/APN—APN-1 Test Set
- TS-59/AP—X-Band Echo Box, \$140.00
- TS-62/AP—X-Band Echo Box
- TS-69/AP—300-1000 MC Frequency Meter, \$69.50
- TS-69/AP—Pulse Voltage Divider
- TS-98/AP—Pulse Voltage Divider
- TS-102/AP—Hantke Calibrator
- TS-111/AP—S-Band Wavemeter
- TS-118/AP—Power Meter
- TS-125/AP—S-Band Power Meter
- TS-127/AP—X-Band Signal Generator
- TS-170/ARN-5—S-Band Test Set
- TS-184/AP—Test Set
- TS-226/AP—300-1000 MC Power Meter
- TS-268/UP—Crystal Test Set
- TS-278/AP—APN-1 Test Set
- IE-19—SCR-522 Test Set, \$290.00
- IE-36—SCR-522 Test Set
- BC-221—Frequency Meter, \$125.00
- BC-227—S-Band Signal Generator, \$275.00
- TRN-3EV—Thermistor Bridge
- CW-60 ARB—S-Band Frequency Meter
- FLUX METER—500-4000 gauss, \$32.50

- APA-10—Panoramic Adaptor
- APA-17—Automatic Direction Finder 250-1000 MC
- APQ-5—Low Altitude Tracking & Bombing Equip.
- APR-1—Radar Search Receiver 40-3400 MC
- APR-2—Radar Search Receiver 85-1000 MC
- APR-4—Radar Search Receiver 38-4000 MC
- APR-5—Radar Search Receiver 1000-3100 MC
- APR-6—Radar Search Receiver 3000-6000 MC

RECEIVING TUBES

0A2	50.95	6AK5	50.88	6B7T	50.98
0A4G	1.05	6AK6	1.09	6BU7GT	2.75
0B2	1.05	6AL5	.52	6E7	.98
0B2	.59	6AL6	.57	6E7T	1.35
1A3	.70	6AQ6	.85	6V6GT	.65
1A7GT	.80	6AR5	1.25	6W4	.65
1E-18 R016	1.85	6AT6	.65	6X4	.80
1C5GT	.75	6AU5	1.19	6X5GT	.65
1D8GT	.65	6AU6	.59	6Y6GT	.95
1G5GT	.65	6B6	.75	6Z6	.75
1L4	.67	6B4C	1.25	7A6	.75
1L4A	.85	6B7	.95	7B7	.75
1L6	.98	6B6	.75	7C7	.75
1L8A	.98	6B8A	.65	7C7	.75
1LCS	.75	6BC5	.75	7F7	.75
1L4	.67	6B8B	.65	7N7	.75
1LN5	.75	6BF6	.72	7Y4	.59
1NSGT	.75	6BGGG	1.89	12A6	.65
1P5GT	1.69	6B8	.85	12C7	.90
1R4	.69	6B8E	.95	12AH7GT	1.19
1R25	.65	6B8G	1.25	12AT6	1.55
1S4	.65	6C5	.57	12AT7	1.10
1S5	.65	6C5	.60	12AU6	.88
1T4	.65	6C6	.59	12AU7	.88
1U4	.65	6C8G	.85	12BA6	.69
1V	.65	6D8	.72	12CR	.69
1X2	1.36	6DB	.85	12NE6	.69
2A3	1.30	6E7	.79	12N8	.72
2X2	.50	6F6	.85	12SA7GT	.79
2K2A	.65	6E7	.85	12SC7	.85
3A4	.65	6H6	.65	12SG7	.85
3A5	.85	6HG6T	.65	12SJ7GT	.85
3B1 1291	.42	6J5	.65	12SK7GT	.60
3B2 1299	.43	6J5GT	.65	12SL7GT	.75
3C4	.63	6J6	.65	12SN7GT	.85
3C5GT	.75	6J7	.65	12SQ7GT	.72
3Q4	.74	6J8	.60	12SR7	.72
3V4	.74	6K6GT	.65	14D6	.75
5R4Y	1.65	6K3	.75	14H7	.90
5T4	1.32	6K8GT	1.15	25L6	.65
5U4G	.69	6L6	2.25	25Z5	.65
5V4G	.98	6L6G	1.50	25Z6GT	.68
5W4	.79	6L6GA	1.50	41	.69
5V3GT	.45	6L7	.85	43	.65
5Y4G	.67	6M7GT	.85	45	.75
5Z3	.85	6R7	.75	50A5	.89
5Z4G	.95	6SA7GT	.65	50B5	.78
6A5	.65	6F7	.65	50C5	.65
6A6	.82	6SF7	.75	50L6GT	.65
6A7	.89	6S6T	.75	50Y6	.72
6B8GT	.95	6H7	.65	50Z7	.65
6B8T	.98	6S17	.75	53	.68
6AC5GT	1.05	6SK7GT	.72	75	.82
6AC6	.65	6L7GT	.75	80	.65
6AG5	.75	6SN7GT	.75	84	.95
6AG7	1.45	6S07	.65	83V	.92
6AG8	.95	6H7GT	.60	84	.92
6AJ5	1.95	6S57	.80	84 6Z4	.75

WANTED! WANTED!

Needed for Government Defense Projects—all types of military electronic gear with the prefix TS, BC, SCR, API, APS, etc. Highest prices paid or will exchange for your needs. No offer too small or too large.

Prices subject to change without notice. F.O.B. NYC. minimum order \$10.00. 20% deposit required. All merchandise guaranteed. Open account to established firms. Telephone DREG 9-0347.

RADIO HAM SHACK INC.

189 GREENWICH STREET • NEW YORK, N. Y.

- APS-2—S-Band Search Radar
- APS-3—X-Band Search Radar
- APS-4—X-Band Search & Homing Radar
- APS-6—X-Band Search & Gun Laying Radar
- APS-15A—X-Band Blind Bombing Radar
- APT-4—Radar Jamming Xmitter 165-780 MC
- APT-5—Radar Jamming Xmitter 352-1400 MC
- SO-13—S-Band Marine Radar, Lightweight
- SQ-10 CM Portable Radar, \$850.00
- TPS-1—Portable Search Radar
- TPS-3—L-Band Search Radar
- UPN-1 & 2—S-Band Portable Beacon Battery or 110v AC
- RA-34—Power Supply for BC-375E, \$225.00
- RA-62—Power Supply for SCR-622
- BC-1016—Ink Tape Recorder
- PE-103—Dynamotor Power Supply, \$24.50
- CN-58—Hand Cranked Generator W/Legs & Seat
- SCR-578—Gibson Girl (Emergency Xmitter)
- CRT-3—Victory Girl Dual Freq. Emergency Xmitter Sound Powered Chest & Headsets MI-2451-B; Type O. Mfg. ICA.
- AS-32/APX-1—Antenna, \$2.75
- AN/CRC-7—V.H.F. Handi-Talkies 112MC Xtal Controlled
- MN/26-V—Compass Receiver
- BC-733D—Receiver with Tubes
- BC-1284—Lighthouse Tube Preamplifier
- BC-996—Interphone Amplifier, \$6.75
- RL-42—Motor Antenna Rev. \$5.25
- 30 MC—i.F. Strips Using 6AK5
- RD-7/APA-23—Recorder for APR
- AS-27/ARN-5—Antenna
- ARA—Receiver—500-1500 KC
- IB-80/APA-17—Indicator
- R-28 ARC—Receiver—100-156 MC, \$24.50
- RM-29—Remote Control
- BC-455—Receiver—5.9 MC
- BC-454—Receiver—3.6 MC
- BC-800—Transmitter/Receiver
- BC-950—Transmitter—100-156 MC, \$34.50
- RA-300—FM Exciter (Mfg. Tempo)
- FL-8—Filter
- FL-5—Filter, Less Cables
- 3C-16-D GSAP—Gun Camera Computers with All Accessories in Carrying Case, \$14.50
- AT-2A/APN-2—Antenna, \$3.75

PANEL METERS

- 2" SQUARE WESTON—SANGAMO
- 0-20 Volts D.C. \$2.95
 - 0-40 Volts D.C. 2.95
 - 0-5 Amp. R.F. 2.95
 - 0-5 Ma. \$2.95
 - 0-500 Microamp. 4.95
 - 0-100 Ma. (0-300 scale) 2.95

XMITTING TUBES

0A3	V75	\$1.04	15R	50.69	86GA	\$1.35
0B3	V950	1.19	2N07	1.95	866J	1.29
0C3	V1910	1.19	30 Spec.	.45	869B	65.00
0D3	VR150	1.19	45 Spec.	3.32	872A	2.95
1B23	9.75	45 Spec.	3.32	872A	2.95	
1B27	9.75	100TH	7.95	878	1.59	
1B27	1.21	100TH	7.95	878	1.59	
1B29	2.45	250TH	19.95	882A	1.39	
1N21B	3.25	250TH	17.95	918	1.10	
1N23	2.39	274B	2.95	923	1.25	
1N23B	3.69	304TH	8.95	927	1.05	
1N34	1.95	307A	8.95	930	1.10	
1N34A	.97	307A RK75	3.95	931A	4.25	
2A40	10.95	316A	6.65	954	.25	
2C40	14.95	328A	8.95	955	.49	
2C43	14.95	350A	6.45	956	.39	
2C46	1.19	350B	3.95	957	.39	
2C46	1.19	350B	3.95	957	.39	
2C51	6.25	371A	.95	959	2.25	
2C52	1.35	371B	.69	991 NE16	.35	
2E22	4.65	393A	3.95	1619	.79	
2E24	4.65	394A	3.95	1613	.49	
2E24	3.15	417A	8.75	1616	.69	
2K25	723AR	4340	27.50	1619	.79	
2K26	28.75	446A	1.15	1622	2.45	
2K33A	32.50	446B	3.75	1624	1.45	
3A1	9.95	501A	5.25	1626	.35	
3B24W	9.95	703A	5.75	1629	.25	
3B26	2.59	703B	13.95	1630	.75	
3C22	115.00	714AY	7.95	1632	.72	
3C24	24G	715B	8.75	163R	.45	
3C24	24G	715B	8.75	1603	1.55	
3CP1	1.95	717A	19.95	2051	1.18	
3CP1S1	1.95	721A	2.45	5670	6.95	
3DP1A	6.95	723A	2.50	800R	5.95	
3DP1-52A	8.95	724R	3.25	8011	.90	
3E29	13.95	726A	18.95	8012	2.65	
3F27	1.65	730A	29.50	8013	2.59	
4-12SA	27.50	800	1.75	8020	.98	
4-250A	37.50	803	3.25	9001	1.50	
4AP10	4.45	804	11.75	9002	.98	
4C35	27.50	805	11.75	9003	1.65	
4E27	14.95	806	24.95	9004	.35	
5AP1	3.45	808	2.69	9005	1.45	
5B1	4.45	810	9.50	9006	.27	
5B2	4.45	811	2.25	C1A	9.95	
5C1	4.59	812	2.25	CGJ	6.39	
5CP7	11.75	813	11.75	CK1005	.48	
5DP1	19.95	814	11.75	F123A	7.75	
5FP7	1.85	815	2.35	F127A	27.50	
5GP1	2.45	816	1.05	FG2A	89.50	
5JP1	22.50	828	9.95	FG2B	8.89	
5LP1	22.50	829	10.95	FG27	4.95	
6AN5	3.30	830B	2.75	FG32	8.95	
6A56	2.50	832	6.75	FG42	1.95	
6A57	4.35	832A	8.55	FG44B	8.95	
6C21	21.00	836A	3.49	FG72	4.95	
6J2	6.75	837	1.45	FG77	8.95	
7B7	6.25	838	2.25	FG82	1.95	
7DP4	14.50	845W	4.25	FG110	3.49	
9LP7	4.95	849C	27.50	FG105	17.95	
10BP4	17.45	851	12.95	FG122A	2.25	
10Y	.39	860	3.95	FG127	33.00	
12DP7	14.75	861	22.50	FG143A	29.95	
13E	8.65	865	98	FG150A	1.79	
				HF000	22.45	
				HF000B	69	
				MY115	6.95	
				ML101	47.50	
				REL21	2.95	
				RK60/1643	2.25	
				RK65	26.50	
				RK72	.48	
				VT127A	2.45	
				WL616	34.50	

Thousands depend on PHOTOFACT! THEY TELL YOU WHY

Unsolicited letters tell what the world's finest TV and Radio Data means to Service Technicians



William T. Duarte
8 Harbour Road
Johnston, 9, R. I.

"Thanks for introducing me to such a well-compiled and tremendously helpful data service as your PHOTOFACT."



N. A. Jacobsen
562 Martha St.
Grand Rapids, Mich.

"Your folders were recommended to me by another serviceman. I'm discovering that I should have them before I tackle any job that looks the least bit tough. It sure was my lucky day when I was introduced to your folders. Really, I don't know how one could service a set intelligently without having the PHOTOFACT Folder on it."



John J. Duplex
Duplex TV & Radio
5153 W. Huron St.
Chicago, Ill.

"I find your PHOTOFACTS a necessary must, and would not consider servicing without them."

NOW! GET THE PROOF FOR YOURSELF!

FREE

We'll send you a Free Photofact Folder on any receiver listed in "PF Index & Technical Digest."

Learn for yourself—at our expense—how PHOTOFACT pays for itself by earning bigger repair profits for you! Select any Folder from the PF Index (if you haven't an index, get a copy from your distributor). When you write us for your Free Folder, be sure to state Photofact Set and Folder Number as shown in the Index. Get your Free Folder now. Examine, use, compare—see why you can't afford to be without PHOTOFACT!

HOWARD W. SAMS & CO., INC.
2203 E. 46th St., Indianapolis 5, Ind.

HOWARD W. SAMS & CO., INC.

Preferably this element should act automatically, for adjustment of two controls when changing frequency is to be frowned upon. This function can be obtained in a number of ways, all of which resolve into an impedance element that varies with voltage or current. In other words, it does not follow Ohm's Law. Such an element may be as complex as the a.v.c. circuit in a receiver; thermistors, or a diode also exhibit the nonlinear characteristic; so does an iron wire, such as a pilot lamp. This is a convenient form, and relatively inexpensive. The 3-watt, 117-volt lamp is almost universal in this application.

The action of the lamp in automatically adjusting its magnitude or resistance to maintain the amplitude of oscillations at a constant level may be seen by the characteristic curve of such a lamp, shown in Fig. 2. In this curve resistance is plotted as a function of impressed voltage, and clearly shows the nonlinear nature of this function. The dashed vertical line indicates the approximate limit of voltage that may be applied to obtain regulator action. Don't expect any light from the lamp—even the faintest red glow of the filament indicates improper adjustment. The characteristic that permits the use of a lamp for regulation is that the voltage developed across it increases more rapidly than the current sent through it. It is the slope of the curve, that is, the incremental resistance, at any point rather than the resistance value at that point that governs the action (Fig. 4). An amplifier with such an element as the negative feedback resistance becomes a very nonlinear device. No matter what magnitude of signal is applied, the output is nearly constant. The range of input is, however, limited by the range of the nonlinear element.

Calibration of the dial involves a known frequency (from a standard oscillator, or the 60 cps power line) and a CRO. With the oscillator feeding the vertical amplifier and the reference signal feeding the horizontal amplifier, Lissajous figures will be produced. Any stationary pattern indicates an integral relationship between the two frequencies. The ratio may be calculated by counting the number of tangent points to a rectangle enclosing the figure. Let the number of tangent points along the top be H ; similarly, the number of tangent points along one side is V . Then H/V is the frequency ratio, and H/V multiplied by the reference frequency gives the frequency of the oscillator. In this manner 10 cps division marks can be made on the lowest band using the 60 cps power line for reference. If the condenser decading is within 1%, no further calibration is necessary up to 200 kc.

A method of checking distortion content of any waveform was mentioned. This requires a CRO and an oscillator with very low distortion. A Lissajous figure of unity ratio is formed. Of



SONOCRAFT FM TUNER \$89.95

Modern design throughout. Compact size (only 4½" high x 10" wide) permits use as a replacement in almost any type of music system, bringing it up to present day standards.

DESIGN FEATURES

- Novel blackout tuning indicator in VTVM circuit
- Drift free—Automatic Frequency Control
- 5 Microvolts sensitivity
- AFC can be disabled in strong signal areas
- Full Armstrong circuit—completely shielded
- Exclusive design of dial plate provides for simple cabinet installation

NOW OPEN A new studio designed for you—right in the heart of New York City. America's finest and most flexible sound demonstration studio—At last you may experience the breathtaking realism of reproduced music.



FREE

WRITTEN FOR
MUSIC LOVERS
BY
IRVING GREENE

124 pages — chock full of valuable information and listings of high fidelity components.

**ALLIED SOUND
CORPORATION**

115 WEST 45 STREET (3rd FLOOR)
NEXT TO TIMES SQUARE
NEW YORK 36, N. Y. LUXEMBURG 2-1750

course, the possibility of two signal sources maintaining a precise phase relationship for more than a few seconds is remote. Therefore the figure will apparently rotate, changing from a circle to an ellipse, to a straight line, and back again. It is the straight line that provides the desired criterion: any harmonic distortion greater than 1% will appear as a bump or loop in the straight-line pattern.

BIBLIOGRAPHY

1. Southworth, Glen; "Build a Sweep Frequency Audio Oscillator," *RADIO & TELEVISION NEWS*, Feb. 1950.
2. Watkins, Loren C., Jr.; "An Audio Oscillator and V.T.V.M.," *RADIO & TELEVISION NEWS*, June, 1950.
3. Sulzer, P. G.; "Wide Range RC Oscillator," *Electronics*, Sept., 1950.
4. Turner, Rufus P.; "Phase Shift Oscillator," *RADIO & TELEVISION NEWS* Oct., 1950, page 112.
5. Dorf, Richard H.; "An RC Beat-Frequency Oscillator," *RADIO & TELEVISION NEWS*, Nov., 1950.
6. Edwards, C. M.; "Precision Decade Oscillator for 20 cps to 200 kc.," *Proceedings of the I.R.E.*, Mar., 1951.
7. Gallagher, Jack D.; "A Bridged-T Audio Oscillator," *RADIO & TELEVISION NEWS*, June, 1951.
8. Heikman, N. C.; "Constant-Amplitude Oscillator," *Electronics*, July, 1951.

-30-

Modernizing the SCR-274/N

(Continued from page 59)

for the final. The use of a stand-off insulator-type r.f. choke makes this easy, using the existing hole between the 1625's for the mount, and the existing plate "B-plus" feedthrough mica insulator for power connections.

Connect the parallel-feed as shown in the top chassis photo and the diagram, forming a conventional pi-type network system, after soldering the top of the coil to the top-chassis left-hand condenser, and the bottom of the coil to the top-chassis right-hand condenser. (Positions as viewed from front of panel.) Use bits of the former tank coil wire for all this, since that silver is hard to beat for r.f.

The hole in the lower right-hand side of the front panel, due to the removal of the dial assembly, etc., is an ideal spot for the midget closed circuit jack J_1 , to which is wired a lead from the final amplifier cathodes, for keying the rig.

A $\frac{3}{8}$ in. punched hole, to the right of the meter, provides for a coaxial fitting, to carry the pi-tank output to the antenna, which can be almost anything, from a short whip to a fancy array. (With some type of antennas, it may be necessary to solder a .0001 μ fd., 2500 volt mica condenser in parallel with the loading condenser, RH pi-net condenser, to get proper and adequate loading.) In our case, we can load to a hundred-and-fifty mils, with approximately 450 volts on the final, which was considered good enough.

The former neutralizing condenser, shown on the chassis lip in the under chassis photo, was not used in our case: it can be left disconnected.

Power for the rig is from a typical junk-box job, using a husky 500 volt,



AN/APS-4
Airborne radar. New.
Complete P.U.R.

AN/APS-6
Airborne radar set. New.
Complete P.U.R.

AN/APR-4
RECEIVER & TUNING UNIT P.U.R.

RADAR TEST EQUIPMENT
Complete line. What are your needs?

Check these Items - Write for Prices!

BC-733-D LOCALIZED RECEIVER. Complete with tubes and crystals.
DM-53-A DYNAMOTOR for above.
FT-293 MOUNT for 733
BC-732 CONTROL BOX for 733.
ARN-7 Complete installation.
SCR-269-G Complete installation.
BC-639 VHF TUNABLE RECEIVER 100-156 MC.
SCR-522 VHF. Complete installation.
DY-112 V DYNAMOTOR—For converting Command Receivers to 12 V. operation.

MT-68 MOUNTING RACK for RTA-11B, R89/ARN-5 GLIDE PATH RECEIVER, R57 GLIDE PATH RECEIVER, BC-638-A FREQUENCY METER, BC-376-H TEST OSCILLATOR, ID6/APN-3 LOBAN INDICATOR, R9/APN-4 LOBAN RECEIVER POWER SUPPLY, RT34/APS-13 TRANSMITTER 420 MC, TS-24/ARR-2 SIGNAL GENERATOR 234-358 MC, BC-640 50 W. VHF XMTR Crystal control 100-156 MC, AN/APS-6 AIRBORNE RADAR SET

Monthly Specials!

RT-34/APS-13 420 MC. TRANSMITTER with 5 stages of 30 MC. 1F amplifier strip. Less tubes & R.F. section. With dynamotor. **\$9.95**

AN/ARC-5
R-28/ARC-5 RECEIVER 100-156 MC. **\$49.50**
With tubes. Like New.
T-23/ARC-5 TRANSMITTER 100-156 MC. With tubes. Like New. **\$17.50**
BOTH UNITS FOR ONLY **\$92.50**

2 TRANSMITTERS
BC-457 (4-5.3 MC) and BC-458 (5-3.7 MC). Command transmitters. Shipment Just In. Limited quantity. Less tubes and xtals. Good cond. EACH \$4.95 PER SET \$9.50

SCR-625 FAMOUS MINE DETECTOR
For prospectors, miners, oil companies, plumbers, etc. New. **\$59.50**
WHILE THEY LAST!

COMMAND EQUIPMENT (SCR-274N)

	Used	New
BC-442 ANTENNA RELAY. Less cond. with cond.	\$1.95	
BC-451 TRANSMITTER CONTROL BOX		\$ 3.95
BC-450 3-RECEIVER REMOTE CONTROL BOX		1.50
MC-215 MECHANICAL DRIVE SHAFT. Per length		2.95
BC-496 2-POSITION RECEIVER CONTROL BOX		2.95
BC-459 Less tubes	12.95	2.95
BC-455 6-9 MC RECEIVER. With tubes	9.95	14.95
Less tubes	7.95	
BC-454 (1-6 MC) With tubes.	9.95	
Less tubes	6.95	

	Used	New
BC-453 With tubes	\$19.95	
Less tubes	14.95	
MC-211 90° ANGLE COUPLING UNIT		\$0.95
FT-234 MOUNTING RACK for single transmitter	2.95	3.50
FT-226 MOUNTING RACK for 2 Command Xmters.		3.95
FT-221 MOUNTING PLATE for FT-220		1.50
FT-220 MOUNTING RACK for 3 receivers		2.25
FT-225 MOUNTING PLATE for BC-456		2.25
BC-456 MODULATOR. For SCR-274.		4.50
Complete set of 4 tubes for transmitter		1.95

TCS

12 V. operation. Transmitter-Receiver Antenna Loading Coil. 1 $\frac{1}{2}$ -10 MCS. 45 W. P.U.R.

LEAR ACTUATOR

24 VDC. Turns 11,000 r.p.m. Geared to 1,100 r.p.m. Excellent condition. **\$9.95**
SPECIAL.

ARC-4 TRANSCEIVER

140-144 MC. Complete with control box, tubes, 12/24 VDC dynamotor with schematic. This is a special reduction for this month only. **\$32.50**
Like new
MT-101 ARC-4. New \$1.50

234-258 MC RECEIVER

11-tube UHF tunable receiver with schematic. New **\$17.95**
Rack \$3.50
Control Box 1.50

Miscellaneous Specials!

HS-18 HEADSET. 8,000 ohms. New	\$2.45
HS-23 HEADSET. High imp. New	4.95
HS-30 HEADSET. Featherweight type. Low imp. NEW	\$2.49 USED 1.49
HS-33 HEADSET. Low imp. New	6.95
HS-38 HEADSET. USED, excel. cond. NEW	1.49 3.50
T-26 CHEST TYPE MIKE. With cord and plug. New	2.75
T-32 DESK STAND MIKE. Good, used cond. Lip Mike. Navy type. New	2.75 .98

BC-709 INTERPHONE AMPLIFIER. With tubes. Less tubes. With manual. NEW	3.95 1.95
PE-101 DYNAMOTOR. Used. ONLY FEW LEFT.	9.95
CD-307 EXTENSION CORD. For HS-23-33. NEW	4.95
RS-38 MIKE. NEW	1.75
Used	
BC-605 INTERPHONE AMPLIFIER. With dual mike input circuit. NEW	5.95
RM-13 COMPLETE REMOTE CONTROL BOX. For 3 separate transceivers. With TS-13 handset, de-coupled output meter and RE-8 ringer unit. 110 V. AC operated. Excel. cond.	29.50
FL-8 RANGE FILTER	1.95

TUBES!	TUBES!	TUBES!	TUBES!	TUBES!
16P4 \$19.95	304TH \$8.95	6CP1 \$4.95	3P17 \$2.25	5P7 \$2.25
16AP4 24.95	804TH 8.95	4.95	JAP10 1.49	000289
16DP4 19.95	830-B 2.75	5P7 2.25	21D69	000199

MP-22 MOBILE ANTENNA. MOUNTING RACK. Complete with hardware. New **\$ 3.95**
TU-17 TUNING UNIT (2-3 MC.) For BC-223 Xmt. Used **2.95**
1-70 75 MC. TUNING METER. NEW **2.50**
WOBULATOR. See p. 43 Dec. '51 RADIO NEWS **5.95**
BC-1023 75 MC. MARKER BEACON RECEIVER. Complete with tubes, mtr. rack. NEW **10.95**
TU-25 TUNING UNIT. (3.5-5.2 MC.) For BC-223 Xmt. Used **2.95**

IN-4A L.R. TUNING METER. Used. **\$ 3.95**
FL-5 RANGE FILTER **1.75**
TS-13 HAND SET TELEPHONE. NEW **7.75**
BC-1033 75 MC. MARKER BEACON RECEIVER. Complete with tubes. P.U.R.
FIELD TELEPHONE. FE-8. Complete BRAND NEW. SPECIAL. ONLY **27.50**

INDUSTRIAL CORPORATIONS

We carry one of the most complete stocks in U. S. of Military Electronic Equipment, Test Equipment, and Aircraft Electronics. Call or write for free catalogue.

COMBO

BC-624 VHF RECEIVER. Freq. range 100-156 MC. Less tubes & crystals, with conversion dope. Used, good cond. **\$19.95**
BC-625 VHF TRANSMITTER. Freq. range 100-156 MC. Less tubes & crystals, with conversion dope. Used, good condition. **\$12.95**
BOTH TRANSMITTER & RECEIVER. Per Set **\$29.95**

\$5.00 MINIMUM ORDER ACCEPTED. All items subject to prior sale. All shipments F.O.B. warehouse, Calif. residents add tax with remittance. 20% deposit required. Please specify shipping instructions with order. EQUIPMENT WANTED! Highest prices paid for all types of Electronic Gear!

ARROW SALES, INC. 7460 Varna Ave., Dept R
North Hollywood, California
PO Plan 5-1810
Cable Address: ARROWSALES

**Preferred
for Original
Equipment**

**Proven
for
Replacement**

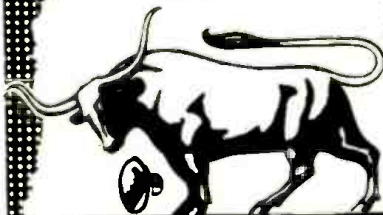
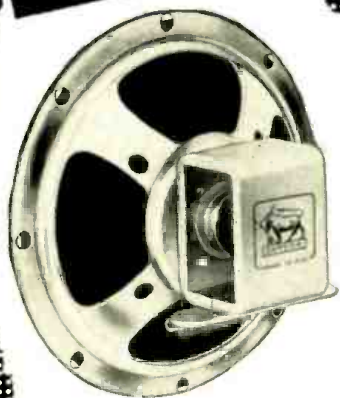

OXFORD

Speakers

There is an application for every Oxford Speaker... and an Oxford Speaker for every application.

**OXFORD
ELECTRIC
CORPORATION**

3911 S. Michigan Ave.
Chicago 15, Illinois

EXPORT: ROBURN AGENCIES,
NEW YORK CITY

200 ma. power transformer, dual chokes, and two 8 μ d., 600 volt condensers, with a VR-150 (OD3) for the regulated 150 volts to the oscillator. A recommended supply is shown in the diagram, with pin connections shown as used by the author. A five-wire cable handles things nicely, and we simply soldered the wires directly to the socket on the rear chassis drop, using a Cinch plug for the power supply chassis end of the cable.

If any difficulty is encountered in resonating the final with your particular antenna set-up and loading condenser capacity used, short out approximately five turns of the pi-net tank coil. The final resonating condenser will then work nicely. To those not familiar with this type tuning net, a review of the pertinent chapter in current "Handbooks" is recommended. Briefly, the input condenser is the resonating one, by which the plate current of the 1625's is dipped, and the output condenser is the loading one, by which the current drawn from the 1625's is placed at a desired value. It is a simple, efficient means of power transfer, and has the happy faculty of giving a wide range of impedance matching.

It has been found in practice that almost any setting of the final pi-net will deliver an almost constant power to the antenna, with a wide frequency range covered on the oscillator tuning condenser, giving virtually one dial control, but allowing any loading desired on the final—a desirable condition.

The rig packs quite a wallop, the rule-of-thumb light bulb test showing a full 40 watts going into the antenna, which can make quite a noise. We feel the equivalent rig, if built from scratch by the ham, would entail a considerably larger monetary outlay, and much more work. So all in all the SCR-274, in its modern garb, has proven to be, for us, the answer to a long-felt problem. For a small auxiliary rig it is ideal, and for the beginner or confirmed low-power c.w. man we feel it is pretty hard to beat.

-30-

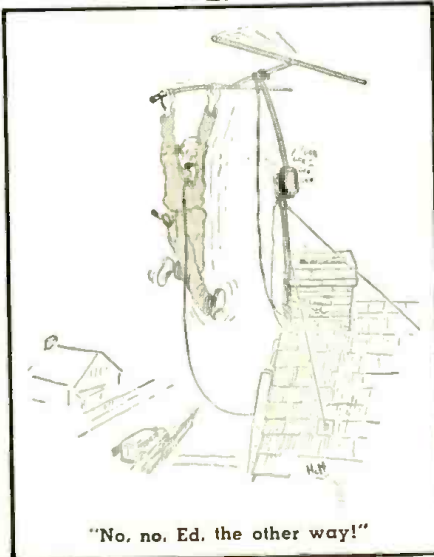

"No. no. Ed. the other way!"

**FL-8 FILTER
AND
"FILTER FACTS"
BOOKLET**

BRAND NEW!

Both for

\$1.25

CONDENSER TESTER

• One of our best sellers! Useful, versatile laboratory item, in kit form. Simple, and easy to build in less than an hour. Checks condenser leakage and continuity up to 8 megs. Will test any paper, electrolytic, mica or oil capacitor from 50 mmf. to 50 mfd. Self-contained power supply and neon bulb indicator with socket and bezel. Drilled metal cabinet. Complete instructions and diagrams included with each kit. Only **\$5.00.**



U-V LIGHT SOURCE

8 watt ultra-violet light source. In kit form including Sylvania black-light tube, (for U-V light in the 3660 Angstrom unit region) ballast, starter, mounting panel, reflector, line cord/plug, hardware, instructions. An invaluable device for schools, labs, service shops, home workshop, etc. Here is a genuine value. Complete kit, (less outer housing) . . . only **\$4.95**

FONE PATCH!

Now available, the superior new O-R, Z6008 phone patch. Provides you with exactly what you need to patch your phone into transmitter or receiver. Featuring a hi-impedance input suitable for XLR mike. Both hi and lo impedance outputs to insure proper match to your particular receiver. Unit is complete—"sure-fire" ready to go to work for you. Only **\$4.95 ea.**



NOVICE TRANSMITTER KIT

A two tube, crystal controlled transmitter covering 3700 to 3750 kcs. . . can be used later for all bands, 20 to 160. Has pi coupler output to match most antennas. Uses 6V6 and 6L6. 35 watts input. Less coils, tubes and crystals. **\$9.90**
Matching Power Supply Kit. **9.90**
One coil, (specify band) **1.05**
Tube kit, (3 tubes) **3.95**
Crystals, (Specify frequency band) **2.75**

SENSITIVE RELAY

Miniature type (1 1/2" overall) SP-ST contacts. Coil resistance 6500 ohms. (2 ma.) An excellent relay for voice control or model applications. **\$2.50 ea.** Manufacturers write for quantity prices.

**SPLINED TUNING KNOB
FOR 274N RECEIVERS**

An exclusive O-R item manufactured for us. Fits BC-183, BC-451 and other 274N receivers. This is a really hard to obtain item. Only **.89c ea.**



TRANSFORMERS-CHOKES:

325-0-325 @ 225 ma. 6.3 @ 5A. 5V @ 3A. Pri. 110V, 60 cy AC. Size, 4 1/8" x 4 1/8" x 3 1/4". Only **\$6.95 ea.**

Isolation transformer. Useful for AC-DC supplies. Pri. 117V. Sec. 120V. AC. at 50 ma. Also 6.3V at 1/2 amp. Only **\$1.80 ea.**

Isolation transformer. Pri. 117V AC. Sec. 120V. AC. at 50 ma. Also 6.3V at 2 amps.

920-0-920 or 740-0-740 AC @ 200 ma. Pri. 115V, 60 cycle, AC. Upright shielded case. Excellent for 807's. Only **\$10.80 ea.**

5V, 25A. Pri. 115V, 60 cy. AC. A real rugged job excellent for 304TL—4-250A etc. Limited quantity. Only **\$4.50 ea.**

2.5V @ 10A AC. 10,000V insulation. Pri. 115V AC. only **\$3.39 ea.**

350-0-350 @ 300 ma. 6.3 @ 4A. 6.3 @ 8A. 5V @ 3A. Pri. 115V, 60 cy. AC. only **\$7.95 ea.**

450-0-450 @ 200 ma. Pri. 115V, 60 cy. AC. 5V @ 3A. 6.3 @ 5 amp. In shielded case. Only **\$8.90 ea.**

350-0-350 @ 350 ma. 6.3 @ 10A. 5V @ 6A. Pri. 115V, 60 cycle. Only **\$8.95 ea.**



**110V, AC POWER SUPPLY
FOR ANY 274-N RECEIVER**

Just plug it into the rear of your 274-N RECEIVER . . . any model. Complete kit and black metal case, with ALL parts and diagrams. Simple and easy to build in a jiffy. Delivers 24 volts plus B voltage. No wiring changes to be made. Designed especially for the 274-N receiver. Only **\$8.95.**

Filament trans. for 274N receivers. Pri. 110V. 60 cy. AC. Sec. 2.4V @ .6A. An excellent buy at **\$1.95 ea.**

Minimum order \$2.00. All items subject to prior sale. All prices subject to change without notice. 20% deposit must accompany all orders. Balance C.O.D.

OFFENBACH-REIMUS
1564 MARKET STREET
SAN FRANCISCO, CALIF.

U.H.F. Antennas
(Continued from page 38)

nected as shown in Fig. 8A to the end of a transmission line and power is fed to these stubs by the line, very little radiated signal is obtained. This is due to the fact that currents of opposite phase flow in the stubs (as indicated by the arrows) and their fields effectively cancel each other. Only in the small end sections (labeled Y) are currents in-phase and these radiate. However, the lengths of these end wires are small and very little effective radiated power is obtained.

It has been found, however, that if a half-wave slot is cut out of a metal sheet, as shown in Fig. 8B, that the non-cancelling currents in the Y ends of the slot circulate about the entire plate and now we have a fairly efficient radiator. With a horizontal slot we get a vertically polarized wave. Since television has standardized on horizontal polarization, a vertical slot would be required.

While the discussion has centered about the slot as a radiator, identical results will be obtained when it is employed as a receiving antenna.

The impedance across the center of the slot is on the order of 500 ohms. This gradually decreases to zero at either end. Hence to properly match a 300-ohm twin-lead line to the slot, it would have to be attached to the slot by connecting one wire to one edge of the slot and the other conductor to the other edge. One conductor may be bonded to the metal sheet, if desired.

The radiation pattern of the slot is similar to a dipole antenna. However, if the slot is cut out of the side of a cylinder, as in Fig. 8C, rather than out of a plate, the radiation pattern tends to become non-directional.

B. Helical Antennas. The helical antenna, Fig. 13, may be looked upon as a form of loop antenna. In fact, Kraus points out that it is related to the straight wire (or linear) antenna on the one hand and to the loop antenna on the other. If the helical antenna were employed for signal transmission, the energy fed in at one end would be "fired" out at the other end. This is shown by the radiation pattern in Fig. 14. The energy is brought to the antenna by a coaxial cable, with the center conductor connecting to the

Fig. 13. A helical television antenna.

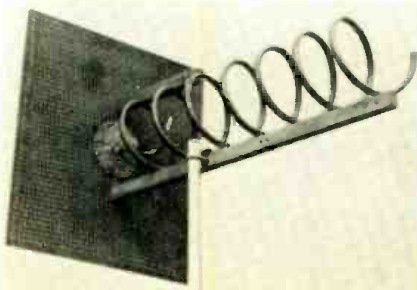

**AIREX
630 FA***

**ONLY AT AIREX...THE MOST
POWERFUL FRINGE AREA
TV CHASSIS MADE**

The CHASSIS That Television Engineers and Servicemen Are Buying for Themselves . . .

This amazingly advanced 32-tube TV chassis is years ahead in engineering and gives you the ultimate in TV viewing and listening pleasure. To assure you trouble free TV our engineering staff has incorporated into the "630 FA" design the experiences of hundreds of TV servicemen and engineers. Receiving range includes stations up to 200 miles away. Nothing has been spared to bring you the finest of TV chassis. Only the best and most expensive parts are used. There is no other chassis that compares with the "630 FA" * for fringe area reception.

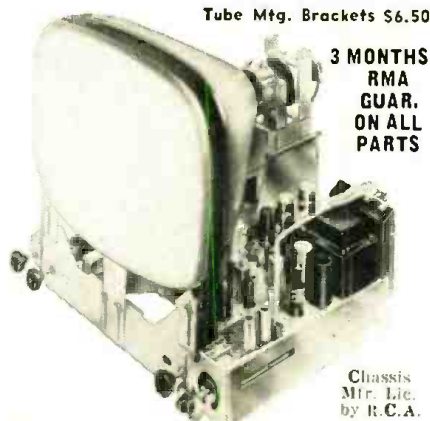

Tube Mtg. Brackets \$6.50

**3 MONTHS
RMA
GUAR.
ON ALL
PARTS**

Chassis
Mfr. Lic.
by R.C.A.

**THE ONLY CHASSIS WITH
PUSH-PULL AUDIO OUTPUT AT**

\$164⁹⁵

Less C.R. Tube
and Brackets

Complete with 12" ROLA Hi-Fi Speaker
(Fed. Tax Incl.)
AND FREE SERVICE MANUAL & SCHEMATIC

✓ CHECK THESE EXCLUSIVE FEATURES ✓

- 10 WATT push-pull audio output. Frequency range from 60 to 12,000 cycles • Link counted Standard Coil Cascade Tuner prevents radiation
- Retrace Blanking Circuit allows you to raise the brightness without the annoying vertical retrace lines • Heavy duty front focus control • Automatic gain control potentiometer allows you to adjust the threshold sensitivity as low as 4 microvolts & still keep the full 4MC band width
- Separate high & low frequency sync amplifiers • Set aligned for 21.75 MC. New Ham band will not interfere • Improved fused high voltage power supply gives full 14.5 KV under load • Will handle all picture tubes up to 24 inch with full sweep • Improved video amplifier has a gain of 32 • All moulded plastic condensers give long life & trouble-free operation
- Easily adapted to new UHF stations in 2

- minutes by just changing a strip in the tuner
- Extra heavy duty power transformer with large safety factor • 6CB6 tubes in Video IF to give full gain • Extra filtering in power supply for hum & ripple free operation • Color connection on chassis which is adaptable to the cathode follower circuit of color converter • Phono Connection & switch on chassis allows you to play your phonograph or tuner through the built-in 10 watt hi-fidelity amplifier • Extra heavy duty focus coil, which runs cool • Tuner can be removed up to 25 feet • Full focus cosine yoke.

**ESPEY FM-AM 12-TUBE CHASSIS
with RCA 12" 201S1 Speaker. \$69.50**

AM TUNER CHASSIS FOR "630"

Fits in well of chassis. Complete with brackets, tubes & instructions. Easy to install. Limited quantity.

\$16⁹⁵

**BARGAIN SPECIALS!
BRAND NEW**

- TV Telescopic Mast complete with hardware, guy wire and base... 30 ft., \$14.95; 40 ft. \$19.45
- Alliance Antenna Rotors, ATR, \$20.49; Directional, \$26.29.
- Garrard RC80 3-speed changer with astatic turnover cart \$42.30
- Presto Call Intercom—2 units, with 100 ft. wire \$24.95
- Standard coil contact cleaners. Self-cleaning action. Set of 4 \$1.50

**REGENCY
BOOSTER
MODEL DB520
Deluxe**

\$19¹¹

**STANDARD
COIL
CASCODE
TUNER**

Complete with tubes & instructions. High gain, low noise.

\$23⁹⁷

**SAVE 50%
RAM CON-
VERSION KIT**

Up to & including 24". Has 15 KV fly-back, 70" cosine yoke. Special width coil, 10W resistor. Complete with schematic. Reg. \$23.95.

\$11⁹⁵

**Save 50%—Brand New
in Factory Sealed Cartons
SILVERTONE
PORTABLE AMPLIFIERS**

Complete with carrying case, 12" speaker, microphone and cable.

- 10 Watt \$42.50
- 20 Watt (Tunable & 2 speakers) \$74.95
- 40 Watt (Tunable & 2 speakers) \$109.95

**TV TUBE EXTRA
STANDARD BRANDS
FACTORY NEW**

1ST QUALITY—GUAR. 1 YEAR

- 17BP4 \$27.95
- 21" TV tube \$39.95
- 20" TV tube 34.95
- 24" TV tube 64.95

**Ring & Sleeve for 24" Tube
\$7.50**

TV GOLD PLASTIC MASKS

FOR CUSTOM INSTALLATION
16" and 17" \$4.95

24" \$14.95

20" and 21" \$7.95

**38 BARGAIN-PRICED CABINETS
FOR THE "630" & OTHER CHASSIS**

Send for FREE folder and price list. Full line table models, consoles, consolettes and TV-Radio Phono combinations. Many styles. Mahogany, blonde, etc.

Complete Service Manual
For "630FA" or Super 630DX—\$1

**SEND FOR FREE NEW TV PARTS &
HI-FI AUDIO EQUIPT. CATALOG**

**SEND POSTCARD TO BE
PUT ON FREE MAILING LIST**

All merchandise is brand new, factory fresh & fully guaranteed. Mail & phone orders filled upon receipt of certified check or money order for \$25 as deposit on TV chassis. 20% on other items. Balance C.O.D., F.O.B. N. Y. Prices subject to change without notice. No Fed. taxes to pay. Prices lower than OPS Regs.

AIREX RADIO CORP.

171 Washington St., N. Y. C. 7, N. Y.
Phone WOrth 2-4029

SOLVE your hi-fidelity problems with University CONE SPEAKERS

-HIGHEST QUALITY! -LOWEST COST!

MODEL 6201 — COAXIAL SPEAKER SYSTEM. Now generally acknowledged to be industry's finest value in a high quality 12" speaker. TRUE coaxial dual range system comprising clean sounding woofer with heavy exclusive Alnico SW magnet, DRIVER TYPE tweeter with "Reciprocating flares" wide angle horn, and BUILT-IN crossover network complete with "Balance" control.

DIFFUSICONE-12 — WIDE RANGE WIDE ANGLE 12" SPEAKER. Exclusive "diffusicone" design utilizes the benefits of dual-horn loading, radial projection and diffraction principles to achieve unsurpassed quality and sound distribution from a single unit speaker. Enjoy full fidelity ANYWHERE in the room . . . of a surprisingly reasonable cost.

DIFFUSICONE-8 — WIDE ANGLE 8" SPEAKER. Same as the Diffusicone-12 except in 8" size. Remarkable fidelity and exceptional sensitivity and power handling capacity make this a truly outstanding eight. Ideal for use where space is limited, and is also a perfect selection for a mid-range speaker in 3-way systems.

MODEL 6200—EXTENDED RANGE 12" SPEAKER. Designed for general applications, capable of highly efficient FULL-BODIED response throughout the operating spectrum. May be used with equal facility to improve commercial radio, TV, phono sets, high quality sound re-inforcement in night clubs, churches, schools, etc., or as a woofer. The 6200 must be heard to be appreciated.

MODEL C-15W—DUAL IMPEDANCE RANGE 15" WOOFER. Brand new low frequency reproducer embodying many exclusive advance features. Its superior response and acoustic output is due, in part, to a newly University-developed cone and voice coil suspension system permitting the greatest axial movement ever achieved. The incredibly low distortion results from a new magnet assembly.

There is a UNIVERSITY Tweeter for every application and pocketbook. Write for descriptive illustrated literature. Address Desk N-12.

University LOUDSPEAKERS INC
80 SO. KENSICO AVE., WHITE PLAINS, N. Y.

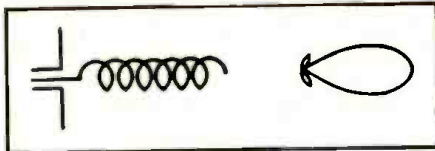

Fig. 14. Helical antenna radiation pattern.

end of the coiled helix and the outer conductor attaching to a reflecting screen. For reception the same type of response curve obtains.

Helical antennas can also be centered with a balanced transmission line, and now the radiation pattern extends in more than one direction. As might be expected, the number of turns in the helix, the distance between turns (i.e., the pitch of the helix) and the circumference of each turn all will affect the response pattern of the antenna. In general, increasing the number of turns causes the beam width to become narrower; increasing the pitch or increasing the turn circumference will have the same effect, within limits.

The response pattern for a helical antenna shown in Fig. 14 holds true when the circumference of the helix turns are on the order of 1 wavelength at the operating frequency. If the helical antenna becomes small and compressed, the radiation pattern closely approaches that of a half-wave dipole. This latter application is not desired for TV reception.

The helical antenna has a broad-band characteristic, enabling it to be used over a 2 to 1 frequency range. By the same token, the input impedance remains fairly constant over the same range.

It might be of interest to note in passing that when the helical antenna is used for transmitting, it radiates a circularly polarized wave. Now most technicians are familiar with vertically polarized waves and horizontally polarized waves. In the former the electric lines of force extend up and down and in the latter they extend in a horizontal direction, or from side to side. In a circularly polarized wave, electrical lines of force may be considered as existing vertically, horizontally, and at all angles in between. This can be readily demonstrated by taking a dipole antenna, holding it in front of a transmitting helical antenna, and then slowly rotating the dipole. The amount of signal picked up will remain constant as the dipole is rotated through a complete revolution of 360°.

For reception, a helical antenna will receive any signal, no matter what its polarization. (There are several exceptions to this but they are not of interest in commercial television.) This is frequently advantageous because while television signals are radiated with horizontal polarization, this may change before the antenna is reached. A strictly horizontally or vertically polarized antenna might therefore not adequately receive all the available signal. A helical antenna, however, will.

(To be continued)

PLATT BEST BUYS!

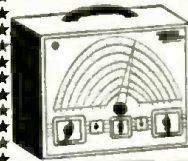

NATIONALLY FAMOUS SIGNAL GENERATOR
Freq. Coverage on fundamentals: 150 KC to 1200 KC. 1.3 to 102 megs on 7 calibrated harmonics. Completely wired & tested—ready for operation.
SPECIAL! \$24.95

TUBES		BRAND NEW! JAN! BOXED!	TUBES
1B22	69c	100H	49c
1B23	53.75c	113B	29c
2B22	49c	215A	99c
2C22	14c	21A	29c
2C24	9c	304TH	55.95
3C20A	99c	316A	29c
3B22	51.1c	371B	99c
3C24	98c	488A	59c
3b6	39c	471A	11.99
3DP1	51.79	513A	51.19
6C	39c	725A	99c
10Y	19c	801A	19c
12K8Y	39c	826	29c
15H	39c	813	17c
39 44	29c		
		804	19c
		954	13c
		1010	49c
		1019	19c
		1029	29c
		1026	19c
		1028	22c
		7193	19c
		0002	69c
		0006	19c
		E1148	49c
		KK34	99c
		VR2	14c
		VT127	15c

ELECTRIC MEGAPHONE SYSTEM

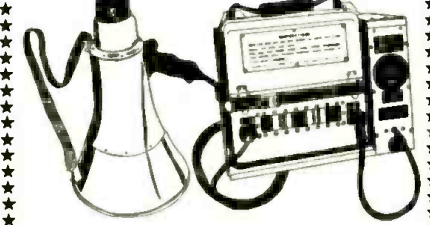

For Rural Areas, Hotels, Commercial Steamers, Ball Parks, Etc.

U. S. NAVY Type PAE-1 Electric Megaphone equipment is designed for voice reinforcement in much the same manner as, but to a greater degree than, the familiar acoustic megaphone. Consists of Megaphone Unit (which combines a microphone and reproducer in a single assembly), Portable Amplifier which electrically amplifies the output signal of the microphone and feeds this amplified signal to the reproducer section. Charging rack for recharging the self-contained storage battery of the portable amplifier. BRAND NEW—A TREMENDOUS VALUE! DEMONSTRATION GIVEN AT EITHER OF \$149.50

SCR-274N COMMAND and ARC-5 EQUIPMENT		EXCELLENT	
RECEIVERS	USED	USED	NEW
BC-453—190 to 550 KC	\$29.95	\$12.95	\$49.95
BC-454—3 to 6 MC		9.95	19.95
BC-455—6 to 9 MC		11.95	16.95

TRANSMITTERS	USED	NEW
A-958—2 to 3 MC		29.95
BC-458—5.3 to 7 MC	7.95	9.95
ARC-5 T-19—3 to 4 MC		24.95
BC-459—7 to 9.1 MC		29.95
T-15 ARC 5—500 to 800 KC		29.95

ADDITIONAL EQUIPMENT		2.49	2.95	5.95
BC-456 Modulator		1.49	1.95	2.75
BC-451 Control Box (3 Receiver)		1.29	1.79	2.39
BC-442 Relay Unit (ANT)		2.39	2.89	3.69
Plugs: PL-147, 148, 151, 152, 153, 154, 156—EACH			1.25	
Flexible Shailing with gear to fit receivers				2.69
3 Receiver Rack	1.79	2.29	2.98	
2 Transmitter Rack	1.69	2.39	3.97	
Single Transmitter Rack			3.95	5.95
DM-32 Dynamotor for Command Set			2.95	3.95
DM-33 Dynamotor for Command Set				
Mounts for 2 Trans. Rack, 3 Rec. Rack, Modulator, & Antenna Relay Unit			1.95	

LIMITED QUANTITY
COMMAND SET BC-455-6 to 9.1 MC. Excellent, 95% completely wired—a few minor parts included require assembling. Instructions included. ONLY \$6.95

COMMAND TRANSMITTER—Navy and Army Type—3 to 4 MC. 75% complete spare parts—LIMITED QUANTITY \$8.95

HEADSETS	
HS-33 low impedance with cord and plug, used, fine condition	\$2.79
HS-23 high impedance, BRAND NEW with ear pads	4.95
HS-33 low impedance, BRAND NEW with ear pads, cord and PL-54 plug	55.39
HS-33—BRAND NEW—Western Electric	5.95
MD-307A Cord, 6 ft. NEW	.89
H-14 U high impedance. Includes two receiving units	3.95
HS-16 high impedance—used	2.49

MINIMUM ORDER \$2.00
Immediate Delivery—Send 25¢ deposit on C.O.D. orders. All shipments F.O.B. N.Y.C. (N.Y.C. residents add sales tax to your remittance.)

PLATT ELECTRONICS CORP.
Dept. A, 489 Broome St., N. Y. 13, N. Y.
PHONES: WO 4-0827 and WO 4-0828
BRANCH STORE: 155 Greenwich St., N.Y.C.

Vibration Pickup
(Continued from page 49)

been completed, the unit may be tried by holding it against a safe or piece of machinery. Power should be on, and volume turned up.

Any noises within the equipment should be readily heard in the ear-phones (as the combination lock is manipulated, or as machinery is operated). The tone control is manipulated for easiest interpretation of the vibrational sounds heard. The ability to interpret the various sounds heard and to properly adjust the "Volume" and "Tone" controls will be gained with practice in using the instrument.

If the instrument seems to be weak, first check the batteries. Also check tubes and all connections for possible errors.

Check the operation of the amplifier alone by disconnecting the pickup cartridge and holding your finger on the input grid. Hum, clicks, and other noises should be heard in the ear-phones.

If the amplifier is operating properly, but the unit still seems to be weak, check the condition of the cartridge used. Also experiment with the exact location of the probe along the case of the crystal—sometimes the sensitivity may be doubled by taking care in locating the probe position with respect to the cartridge. There are no general rules for selecting the best location—this will vary with the type of cartridge used, and must be determined experimentally by trial and error.

When the unit is used to listen to vibrational sounds, it is often possible to select the particular sounds desired by experimenting with the way the probe is held against the machinery being checked. In some cases better results are obtained when the probe is held at right angles to the machinery housing; in other cases, holding the side of the probe against the housing will give better pickup. The pressure exerted in holding the probe will also affect the pickup. Again, experience and practice will best enable the user to develop the proper techniques.

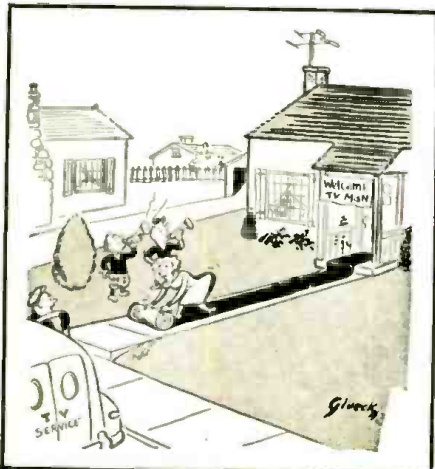

**ORDER BY MAIL FROM
WHOLESALE RADIO**

Low Prices • Complete Stocks • Fast Shipments

SNYDER TV ANTENNAS

YOUR CHOICE
3.95
each

Reg. \$4.95
CONICAL ARRAY



All channels, 8 hi-tensil aluminum alloy elements. Snyder model XA-14 less masts.

\$2.95
each

In Lots of 6, Models may be combined for quantity discount.



Reg. \$4.39
HI-LO ARRAY

2 folded dipoles (H & V) with reflectors. The best all channel folded dipole anywhere near this exceptionally low price. All-21 less mast.

Reg. \$4.95
DOUBLE V TV ARRAY

Hi-gain for fringe areas. 4 hi-tensil 3/8" aluminum alloy elements. 2 aluminum alloy 1/2" crossarms. Completely pre-assembled. Model AHS-25 less mast.

All Directional TV AERIAL

Same Clear Pix as Motor Rotating Aerial Systems Costing Triple! **\$18.95**

FOR FRINGE AREA

COMPLETE with three 3/4" ft. masts, 75 ft. 3 cond. cable, beam selector sw., guy rings and mounting base. Electrically beams complete 360° rotation to give clear pic on all channels. You choose direction with directronic selector sw. mounted on or near TV set. Complete double all-tensil array with 18 hi-tensil double alloy aluminum elements. AX-599 same as TX-599 less masts, guy ring & mtg. base \$16.95

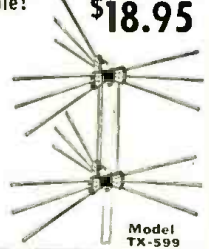

Model TX-599

YAGI TV ARRAYS

For Fringe & Ultra Fringe

Highly directional and closely tuned to each channel. Cuts interference and noise to a minimum. Five elements: one folded dipole, three directors and one reflector. Individual array for each channel desired.

Low Channels	High Channels
2-11V2	7-11V7
3-11V3	8-11V8
4-11V4	9-11V9
5-11V5	10-11V10
6-11V6	11-11V11
	12-11V12
	13-11V13

\$7.95 **\$4.95**

LOWEST PRICES ON TV ANTENNA ACCESSORIES!

STEEL EXTENSION POLES. Weather treated. 5 ft. long, 1 1/2" di. Straight ends.....	\$1.95
5 ft. long, 1 1/2" di. Crimped end.....	1.19
CHIMNEY MOUNT BRACKETS.....	1.59
Complete with strap, pre-assembled.....	3.75
HEAVY DUTY MAST BRACKETS W/2. Adj. to 18" from wall. Pair.....	.39
ANTENNA SWIVEL BASE. Aluminum. Fits 1 1/2" O.D. mast section.....	.39
GUY WIRE. 6 stranded #20.....	1200 ft. 6.00
50 Feet.....	
24 interconnected 50 ft. reels.....	

300 OHM TWIN LEAD. Per ft. 2 1/2c; 100 ft. \$1.95; 1000 ft. \$17.50	
DOUBLE POLE DOUBLE THROW KNIFE SWITCH	.45
RMS LIGHTNING ARRESTOR. Model LA-3. Standard or open 300 ohm line. UL approved.....	.59
ANTENNA WALL MOUNTS. PAM-1 for poles 1 1/2" di. 6" from mast to wall. Pair.....	1.15
PAM-2 for poles 1 1/2" di. Up to 12 1/2" from wall. Pair.....	1.89
TIE RODS for stacking 2 Yagi arrays. Specify H or Lo Band.....	.85

VTVM Kit with 7 1/2" Meter
Precise Deluxe Model 907



\$38.98
Factory Wired \$57.98

Meter can be mounted for vertical or horizontal use. Etched scale; 1% ceramic resistors; amplified connections; separate 5 V AC scale. Tubes: 6A5, 6X5, 6SN7; true zero adjust; huge 7 1/2" meter for more accurate readings. Complete with construction book, battery, and test lead. Ranges: Plus DC: 0-5-25-250-500-1000 v. Minus DC: 0-5-25-250-500-1000 v. AC: 0-5-25-250-500-1000 v. Ohms: Rx1, Rx10, Rx100, Rx10,000. Rx1,000,000 ohms. DB: from -2 to +25 DB.

PRECISE RF-AF-TV MARKER GENERATOR KIT



FUNDAMENTALS THRU 110 mc
330-mc on HARMONICS
Audio: 20-20,000 cycles. Cathode follower output variable Per cent modulation. Stepping attenuator. External Modulation. Speech amplifier. Crystal marker.

With preassembled RF head, 630 KA. **\$38.95**
Completely factory wired, 630 W. **\$53.95**

"Precision" Universal AF Sine Square & Pulse Gen. 635 K Kit..... **\$33.50**

635 W Factory wired **\$52.50**

Address Orders to Dept. RN-1

Write for Free FYI Bulletin

WHOLESALE RADIO PARTS CO., Inc.

311 W. BALTIMORE ST., BALTIMORE 1, MD.

STRIP-IT A New Precision Tool

For Removing Insulation from Wire and Cable
Designed for the Electronic Industry

- Fits in Tight Spots
- Cuts as Well as Strips
- Speedy, Efficient, Rugged
- Tool Steel Blades for Long Life
- INSTANT Adjustment to All Wire Sizes



Economically Priced **\$1.95** net

The simple design and fool-proof operation of STRIP-IT makes this a tool that will become indispensable for electronic technicians and assemblers. Held in the palm of the hand, the operation is merely to bite into the insulation, twist, pull, and the wire is ready for the terminal connection. The sliding adjustment bar is set with a touch of the finger. STRIP-IT is engineered for thousands of operations, using only one set of blades.



SEE YOUR LOCAL DISTRIBUTOR, OR WRITE
MANUFACTURING COMPANY

Narman R. Mac Innis, 1430 Mass. Ave., Cambridge, Mass., National Sales Representative

Money Makers

For 2-Way Radio Service Engineers

Make sure yours is a money-making business! Don't be stymied with "limited-range" frequency and modulation-measuring equipment. Lampkin instruments allow you to pick up extra accounts at additional frequencies, with no further investment!

The Type 205 FM Modulation Meter For Multiple Mobile Frequencies.



The Type 205 FM Modulation Meter measures peak frequency swing due to voice modulation of FM transmitters, as required by the FCC. Indicates 0-25 KC. deviation. Instantly tunable to any frequency from 25 MC. to 200 MC. Simple to use. Direct reading. No charts. No tables. \$240.00.

For Any Number of Frequencies, AM or FM. The Type 105-B Micrometer Frequency Meter



The Type 105-B Micrometer Frequency Meter measures center frequency deviation on any number of transmitters, AM or FM, from 0.1 MC. to 175 MC. The accuracy, determined by over 500 field tests, is conservatively guaranteed better than 0.0025%, surpassing FCC requirements. Readily checked against WWV. \$220.00. Return coupon TODAY for complete literature.



LAMPKIN LABORATORIES, INC.
MFM DIVISION
Bradenton, Florida

LAMPKIN LABORATORIES, INC.
MFM DIVISION
Bradenton, Florida

Please send me complete technical literature and delivery information on the following Lampkin-designed instruments:

- Type 205 FM Modulation Meter
 Type 105-B Micrometer Frequency Meter

Name.....

Address.....

City.....Zone.....State.....

NEW TV PRODUCTS on the Market.....

SYLVANIA 1953 TV

Among the new receivers being introduced by *Sylvania Electric Products Inc.*, is "The Lexington", a 21" deluxe combination, AM and FM radio, and 3-speed phonograph.

Designated as the Model 178, the new console features "HaloLight" and the company's "Stratopower 508" chassis. The cabinet is of hand-rubbed mahogany veneer with rosewood grained doors. The model is available with built-in all-channel u.h.f. reception.

Two wood finishes are offered, with the mahogany finish being designated as the Model 178M while the blonde finish is known as the Model 178B.

"PICBOOST"

C-B-C Electronics Co., Inc., P. O. Box 1556, Philadelphia 5, Pa., has introduced a new series of picture tube brighteners which have been trademarked the "Picboost Pacemaker".

The new unit is said to restore new tube brilliance, for periods up to several years, to any size or type picture tube. Other models in the series will permanently relieve heater-to-cathode shorts, thereby restoring brightness control, according to the company.

The "Pacemaker" can be installed within a few minutes, just by plugging in. No soldering is necessary and no 117 volt a.c. lines are used.

The four models currently available include the Models 1F and 2F, which



restore brightness to dim picture tubes in parallel and series circuits respectively, and the Models 3F and 4F to relieve heater-to-cathode shorts only, in parallel and series circuits respectively.

STANCOR TUBE BOOSTER

Standard Transformer Corporation, 3580 Elston Avenue, Chicago 18, Illinois, is in production on a CR tube booster, a compact, self-contained de-

vice designed to add months to the useful life of a television picture tube.

The tube booster, P-8192, can be used with all electromagnetic picture tubes irrespective of size, where dimming is due to low cathode emission.

Easy to install, the new booster measures only 3½" high and 1½" in diameter. It does not require a.c. line connection and is equipped with a "high-low" switch providing two levels of brilliance. Of autoformer construction, it has 18-inch leads between the booster and connector plug, allowing the booster to be placed anywhere in the set.

U.H.F. ANTENNAS

Technical Appliance Corporation of Sherburne, New York, has announced the availability of a complete u.h.f. antenna line.

Designed to meet the specific needs of various localities, the new line includes parabolic-reflector types, yagis, modified "X", and "V" type antennas. With the exception of the modified "X" design, all are of the sharp directivity type. The modified "X" will be marketed in areas where reception from channels in opposite directions is required. Tuning of all antennas is such that all operating u.h.f. channels will be within the antenna's bandwidth.

Catalogue 83 covering this new line of u.h.f. antennas is available on request.

"SUPER AUTOBOOSTER"

Production of a new four-stage "Super Auto booster" has been announced by *Industrial Television, Inc.*, 369 Lexington Avenue, Clifton, New Jersey.

The Model IT-102A utilizes the new 6BK7A dual-triode in a multiple resonant circuit which provides a uniform 18 db gain over both bands.

Designed for general booster applications requiring uniform high gain at moderate cost, the new unit has a low noise factor resulting in high usable gain even with the new "low noise" TV receivers.

The wideband booster has automatic "on-off", heavy-duty transformer-type power supply, and a metal cabinet. It is operated by a thermal "on-off" switch.

CR TUBE ANALYZER

The Jackson Electrical Instrument Company, 18-46 S. Patterson Blvd., Dayton 2, Ohio, has introduced a new test unit, the Model 707 dynamic cathode-ray tube analyzer.

The new instrument is designed to completely and accurately test all TV

RADIO & TELEVISION NEWS

picture tubes, both magnetic and electrostatic deflection types. It will also analyze oscilloscope, radar, and other special purpose CR tubes without removal from the chassis or carton.

Four classes of tests are made with the analyzer. The beam current test is made to the final anode rather than to the grid or any other element. The beam current scale of the meter not only indicates sufficient or insufficient beam current, but also gives an accurate forecast of remaining tube life.

A grid test, a gas test, and inter-element leakage test are also performed by the unit.

Full data on this new Model 707 is available from the company.

JFD ANTENNA LINE

JFD Manufacturing Company, Inc., 6101 16th Avenue, Brooklyn 4, New York, has developed a complete line of antennas for u.h.f. television reception.

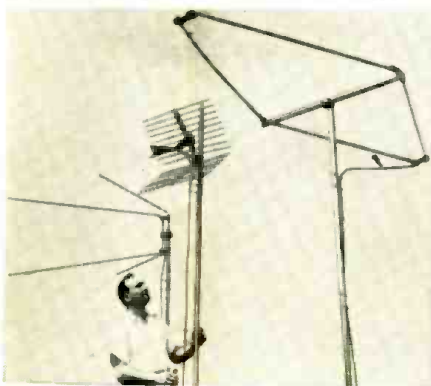

Included in the new line are rhombics, single and stacked "V's", corner reflectors, and a combination "JeTenna-u.h.f." antenna.

This latter unit, the Jet 283, is designed for areas where both u.h.f. and v.h.f. stations will be in operation. It combines the features of the company's "fan-front" unit with a broad-band triangular dipole u.h.f. antenna. A single lead-in wire delivers signals to the set through use of the company's unique coupling device.

Literature on the Jet 283 and other u.h.f. antennas produced by the company can be obtained by writing direct to Mr. Edward Finkel, sales manager of the firm.

TV COVERAGE CALCULATOR

Pioneer Electronic Supply Company, 2135 Prospect Avenue, Cleveland 15, Ohio, is now offering a new television signal-range calculator to the trade.

Designed as an easy-to-use slide rule, the new unit will quickly show the approximate grade "A", grade "B", and city coverage for all v.h.f. and u.h.f. television channels. Practical design permits coverage radius to be read directly on the scale, with one rule setting, for stations operating with effective radiated powers from 10 kw. to 1000 kw., and for antenna heights up to 3000 feet.

While useful to television transmitter engineers, the rule was designed especially as a handy TV service and

SEE LEO FIRST FOR hallicrafters

I can SAVE you money... Liberal Trade-ins



SPECIAL NOTICE—NEW SX-73 NOW AVAILABLE AND IN STOCK — \$975.00



\$179.50

S-76 RECEIVER

Extra selectivity with double superheterodyne circuit. One RF, two conversion and 3 IF stages. Range 550-1550 Kc, 1.7-34 Mc in four bands. 8 tubes plus voltage regulator and rectifier. Complete with tubes, less speaker.



\$224.50

SX-71 RECEIVER

Double Conversion sharp selectivity, plus built-in NBFM at moderate cost. 11 tubes plus voltage regulator and rectifier. Low down payment.

NAME YOUR TERMS • LOW DOWN PAYMENTS • PERSONALIZED SERVICE

HALLICRAFTERS RECEIVERS AVAILABLE FOR IMMEDIATE SHIPMENT

S-81	\$49.50	S-40B	\$119.95	ST-83	\$129.95
S-82	\$49.50	S-53A	\$ 89.95	S-78A	\$ 89.50
A-84	\$99.50	S-72L	\$119.95	SX-62	\$299.50
S-38C	\$49.50	S-77A	\$119.95	S-72 Portable	\$109.95
R-46 Speaker	\$19.95	HT-20 XMTR	\$349.50		

Famous WRL RADIO REFERENCE MAP 25c



CU on 10-20 & 75 Meters

NEW LOG BOOK 25c

For mobile or fixed station. Spiral binding. Full column log listing all FCC required info. Will accommodate 1,525 stations. Q signals, phonetic alphabet, amateur international prefixes.

PHONE 7795

WRITE—WIRE



IT'S NEW! IT'S FREE!

WRL 1953 CATALOG

Send for your copy today. Contains everything new in radio and television. Jam-packed with bargains. Leo I. Meyerson, WØGFO

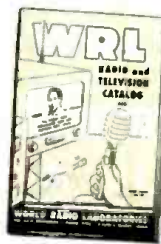

Send For FREE Copy

WORLD RADIO LABORATORIES
744 West Broadway
Council Bluffs, Iowa

R-1

Please send me:

- Radio Map SX-71 Info
 New Catalog S-76 Info
 Used Equipment List New Log Book

Name

Address

City..... State.....

WHAT HAVE YOU?

Turn Your Excess Gear Into Ready Cash!
Especially Need BC-348, BC-342, ART-13, I-152, BC-788, BC-611, and any other surplus equipment.

For Top Prices, Write

BOB SANETT

5404 1/2 Packard St. Los Angeles, Calif.
Phone: WEbster 1-7414

RADIO COURSES

- RADIO OPERATING • CODE
- RADIO SERVICING • ELECTRONICS
- F.M. TELEVISION
- PREPARATION FOR CIVILIAN, MARITIME, ARMY AND NAVY LICENSE REQUIREMENTS.

Write for Catalog T.S.

YMCA

TRADE & TECH. SCHOOL 15 W. 63 St., N. Y. 23
ENdicott 2-8117



SOUND POWERED PHONES RCA-MI-2454

Complete with 24' of Rubber Covered Wire.
NEW EXPORT PACKED
Shipping weight 6 lbs.
\$9.95 per set
2 for \$19.50
EACH SET GUARANTEED
Brand New. Gov't Cost \$42.00

RCA
MI-2475
SOUND

POWERED PHONES

complete with 22' rubber covered cable press to talk switch are light weight, the mic is on a swivel boom that can be moved to any position in front of face. Cost \$62 ea.

Price \$14.95 Ea.

Include postage with order.

McCONNELL'S 3834 Germantown Ave. Phila., Penna. RA 5-6033



24 HOUR
DELIVERY
FROM STOCK!

RELAYS

Our stock of more than a million relays — in over a thousand different types — is the world's largest. Don't delay your production for want of large or small quantities of relays of any type.

Telephone, wire or write for quotations.

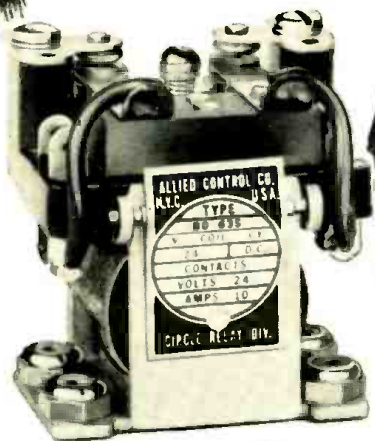

NEW AND MORE
COMPREHENSIVE

1953
RELAY SALES
CATALOG
NOW READY

Be sure to send
for your copy



Telephone

SEeley 8-4146

**Relay
Sales**

833 W. CHICAGO AVE.
DEPT. 8, CHICAGO 22, ILL.

installation aid. With this calculator any TV service technician can quickly estimate signal strength from 5 to 100 miles and have a good "customer-convincing" basis for recommending a particular antenna installation.

Complete information on the calculator is available from Mr. Phil Jeffries, the general sales manager of the firm.

IMPEDANCE MATCHER

Rytel Electronics Mfg. Co., Inglewood, California, is now in production on a new unit which is engineered to balance the impedance between any antenna and the lead-in with which it is used.

Tradenamed "AIM", the new unit takes care of the impedance matching automatically. According to the company, the new unit will increase signal strength to the receiver on all channels (2 through 84), it will help eliminate snow and provide clear, sharp pictures in any reception area, it will give 3 to 7 additional db gain on all channels, and will prevent standing waves on the line.

The junction box measures 2 5/8" x 1 3/8" x 1". It weighs 8 ounces complete with the U-clamp and approximately 47" of wire.

Full details on this new product are available from the company at 9820 Irwin Avenue in Inglewood.

AMPLIFIED SYSTEM

Amplitel, Inc., 360 W. 57th Street, New York 19, New York, is currently offering a new master amplifier TV antenna system which has been designed especially for large apartment buildings, hotels, hospitals, institutions, television dealers, etc.

The new unit is an amplifier system, designed to produce peak reception on each channel in an area—on every television set in the building regardless of location. According to the

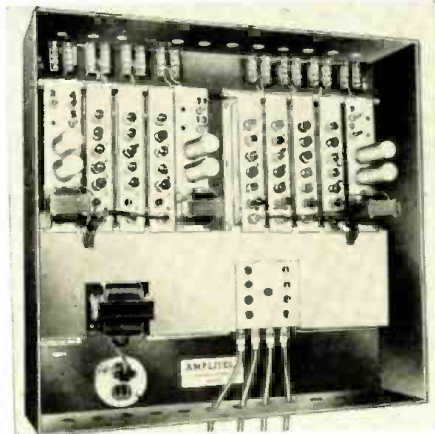

company, there is no interference between sets and no cross-modulation between channels.

Complete technical specifications on this new antenna system are available upon request to the company.

TUNER CLEANER

Conrac, Inc., 649 W. Foothill Blvd., Glendora, California, has introduced a

AMERICA'S FASTEST GROWING TV ANTENNA MANUFACTURER DAVIS ELECTRONICS

THERE MUST BE A REASON

THE REASON IS: The DAVIS SUPER-VISION is the finest antenna built for V.H.F. ALL CHANNEL and for FRINGE AREA and DX RECEPTION...With ELECTRONIC DIPOLE SEPARATORS. A steady flow of enthusiastic letters from users all over the U. S. attests to this fact—and is outstanding proof of its UNIVERSAL ACCEPTABILITY.

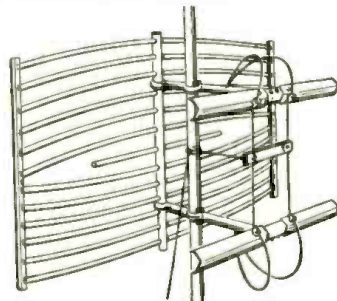

"THE ORIGINAL ANTENNA SOLD WITH
A MONEY-BACK GUARANTEE"

1. EXCELLENT FOR FRINGE AREA and DX RECEIVING—and broad band receiving with high gain on all channels—2 through 13.
2. CLEARER PICTURES UP TO 125 MILES OR MORE—from the station.
3. GHOST PROBLEMS REDUCED or eliminated due to excellent pattern.
4. PROVIDES 10 DB OR MORE GAIN ON HIGH CHANNELS where gain is needed most.
5. EXCELLENT FRONT TO BACK RATIO on all channels. No co-channel interference.
6. MINIMIZES INTERFERENCE: Airplane Flutter—Diathermy and Ignition—F.M.—Neon Signs—X-Ray—Industrial—Etc.
7. ELIMINATES DOUBLE STACKED ARRAYS, and out-performs 2 bay yagis on low band and 4 bay yagis on high channels.
8. ONLY ONE TRANSMISSION LINE NECESSARY.
9. NO WORRY OVER POSSIBLE CHANNEL CHANGES on either high or low channels.

AT YOUR JOBBERS, OR WRITE TO:

DAVIS ELECTRONICS 1-23
4313 West Magnolia Blvd., Burbank, California
SIRS: RUSH INFORMATION TO ME AS CHECKED BELOW:
 Send Free Technical Data on new SUPER-VISION ANTENNA.
 Send Name and Address of NEAREST JOBBER.
Name _____
Street _____
City _____ State _____

SAY YOU SAW IT IN RADIO & TELEVISION NEWS

**MORE
CASH**

For Your
Radio Equipment

We've moved—and need Radio & Hi-Fi parts and equipment to fill our new warehouse. Write:

CANDEE-AIRCO
Dept. T-9, P. O. Box 1187
Magnolia Park Station
Burbank, Calif.

AC-DC MUSIC AMPLIFIER

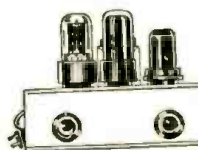

Volume and tone control.

1.5 w. output.

See your jobber.

MICHEL MFG. CO.
227 N. Water St.
Milwaukee 2, Wis.

RADIO & TELEVISION NEWS

new device which perpetually cleans both rotating and stationary contact points on all standard television tuners.

Tradenamed "Tuner Kleen'r", the new product consists of a plastic back covered by nylon which, in turn, is impregnated with a special cleaning agent. Produced to close tolerances, the unit is installed in the tuner by removing a pair of the unused tuner strips and substituting the cleaner device.

-30-

Spot Radio News
(Continued from page 18)

charged the normal calm of Commissionland. For his arrival is expected to cause some broad changes, particularly in the chairmanship of the group and the nomination of a new Commissioner to replace the recess appointee, Eugene Hyde Merrill, former director of the Materials Branch in the Defense Production Administration, who succeeded Robert Jones.

The naming of a new chairman may not be possible until June 30, when Walker's term expires. Actually, the present headman is serving on a special appointment from the President, having been asked to take the chair even though he had passed the retirement age; the late President Franklin Roosevelt had named Walker as a Commissioner in 1934. According to the established mode of procedure, the chairman is expected to be of the same political party as the President. Accordingly, two members of the Commission have appeared as possibilities for the appointment: Rosel Hyde, now serving as vice chairman, and George Sterling, both Republicans.

The appointment of Merrill was quite a surprise and was made public during an address by President Truman at Brigham Young University in Salt Lake City. Said the President: "This morning I signed a paper appointing to the FCC a distinguished resident of your state, Eugene H. Merrill. I thought you might be interested in that, because I understand that Mr. Merrill's father was a member of the board of this university. Of course, that was a good recommendation for him, as far I was concerned..."

Merrill's tenure, technically, will expire when Congress convenes in '53; his name must then be submitted to the Senate committee for confirmation. It is believed that the name of another candidate for the post, a Republican, will probably be sent to the Senate for such confirmation.

THEATER TV, shelved and reshelved on a dozen occasions, received a brief airing a short time ago during a special hearing in Washington which featured testimony by the Motion Picture Association of America and the National Exhibitors Theatre Television Committee.



Sensational TUBE SAVINGS

70% to 90% Off List!

Thousands of tube buyers have recognized the tried and true performance, plus economical service of Rad-Tel fully guaranteed tubes. Each tube is rigidly tested, each tube is a standout value—sufficient reason why Rad-Tel tubes are the sensation of the nation.

All Tubes Individually Boxed! Same Day Service!

✓ **Check this list for Fully 90-Day Guaranteed Tubes**

Type	Price	Type	Price	Type	Price	Type	Price	Type	Price
0B3/VR90	.75	5V4	.73	6BF6	.37	GU4	.60	1A17	.60
1A5CT	.46	5W4	.50	6BG6G	1.25	GU5	.44	14W7	.60
1A6G	.59	5X4	.40	6BH6	.46	GU6	.63	19BG6G	.95
1A7CT	.47	5Y3G	.32	6BJ6	.39	GU8	.61	19C8	.70
1A8S	.59	5Y3GT	.35	6BK7	.59	GV3	.93	19T8	.79
1B3	.65	5Y4G	.46	6BL7	.59	6V6GT	.39	19V8	.89
1B5	.59	5Z3	.46	6BQ6GT	.72	6W4CT	.44	24A	.63
1B7GT	.59	6A3	.59	6BQ7GT	.72	6W6GT	.44	25A V5	.83
1C5GT	.43	6A7	.59	6BY5	.65	6X4	.37	25BQ6GT	.62
1E7	.29	6A8	.62	6BZ7	.90	6X5GT	.37	25L6GT	.39
1H4G	.48	6A8A	.44	6C4	.37	6Y6C	.48	25Z5	.40
1H5GT	.40	6A8S	.43	6C5GT	.39	7A4	.47	25Z6GT	.37
1C6	.60	6A9S	.44	6C6	.58	7A7	.53	25W4	.56
1L4	.46	6A9S	.44	6C8	.44	7B4	.44	26	.45
1LC5	.51	6A9S	.44	6C8B	1.11	7C6	.40	27	.39
1N5	.46	6A9S	.44	6D6	.45	7E6	.49	35B5	.40
1P5	.58	6A9S	.44	6E5	.48	7F7	.59	35C5	.39
1Q5	.58	6A9S	.44	6F5GT	.39	7X7	.70	35L6GT	.41
1R5	.45	6A9S	.44	6F6	.37	12A15	.37	35W4	.37
1S5	.39	6A9S	.44	6G6G	.52	12A16	.36	35Z5GT	.37
1T4	.45	6A9S	.44	6H6GT	.41	12A17	.37	35Z6GT	.37
1T5	.53	6A9S	.44	6J5GT	.37	12A18	.38	40	.60
1U4	.45	6A9S	.44	6J6	.52	12A19	.43	41	.42
1U5	.39	6A9S	.44	6K6GT	.37	12A20	.39	42	.42
1V2	.63	6B4G	.64	6J7G	.43	12A21	.59	43	.55
2A3	.70	6B5	.64	6J8	.69	12A22	.48	45	.55
2X2	1.50	6B6	.64	6K5	.47	12A23	.69	50B5	.39
3A4	.45	6B7	.57	6K7	.44	12A24	.38	50C5	.39
3E5	.46	6B8	.57	6L6G	.64	12A25	.45	50D6	.41
3Q4	.48	6B9	.57	6Q7	.45	12B26	.45	50L6GT	.46
3Q5GT	.49	6B9S	.59	6S4	.38	12B27	.45	50Y6	.46
3S4	.46	6B9S	.59	6S8	.53	12B28	.39	50Y7	.50
3V4	.47	6B9S	.59	6S7GT	.43	12B29	.63	70L7GT	1.09
5U4G	.45	6B9S	.59	6S7GT	.41	12J5GT	.42	75	.41
				6S7GT	.46	12J6GT	.39	76	.44
				6S7GT	.41	12J7	.70	77	.57
				6S7GT	.73	12S4GT	.44	78	.47
				6S7GT	.41	12S5GT	.52	80	.80
				6S7GT	.41	12S6GT	.44	83V	.35
				6S7GT	.48	12S7GT	.48	85	.59
				6S7GT	.52	12S8GT	.47	85	.59
				6S7GT	.37	12S9GT	.52	117Z3	.37
				6S7GT	.45	12S9GT	.44	117L7	.99
				6S7GT	.42	12S9GT	.49	807	.99
				6T8	.56	14A7	.50	2050	1.85



"Integrity Is Our Chief Asset"
Phone: Essex 5-2947

TERMS: A 25% deposit must accompany all orders—balance C.O.D. All shipments F.O.B. Irvington warehouse. Orders under \$10—\$1.00 Handling Charge. Subject to prior sale.

Enlarged Quarters to Serve You Better!
115 COIT STREET
IRVINGTON 11, N. J.

SUPER SURPLUS VALUES

VARIAC GENERAL RADIO CO. 200C 5 to 7 1/2 AMP 115VAC in 0-135VAC out from new equip. **\$13.95**

AC-METER 0-150VAC Weston or West. 2" R. **\$3.95**

MOTOR 4 pole shaded pole induction 1700 RPM G.I. 1/70 HP running torque 12 oz. inches list \$12.00 Fine wire or disc recording. **\$3.50**

HEADSET TELEX monoset Mod. 2570 reg. 14.00 **4.95**

MICROPHONE SHURE 707A & 821B desk stand. **4.95**

RECTIFIERS Fed. Sel. 401D2787 150 MH 130V **.75**

CIRCUIT BREAKERS Heilmann Cal. 6711 5 amp 115VAC curve D \$1.25 30 Amp 115VAC. **1.65**

POWER TRANS. Thordson 70102 350-350 145 mh 5V 4.5 Amp from used equip. **2.95**

OUTPUT TRANS. RCA pair 614 class AB 16 watt Sec. 4-8-15-250 ohms a real DU new. **1.50**

CHOKES THORD. 13C30 8 H. 150 MH 200 ohm. **1.25**

CHOKES CHICAGO trans. Co. 6 H 80 mh 50 ohm **.75**

1000 MFD 15 VDC Sprague C41A Condenser. **.95**

3500 X 3500 MFD 25VDC Solar 10ZP 4 pin can. **1.50**

XTALS 2 meters 144.16 MC DC3 holder. **1.50**

XTALS 500 KC standards CR-2B U special. **1.50**

Include postage with order. Min. order \$3.00

McCONNELL'S 3834 Germantown Ave. Phila., Penna. RA 5-6033

RADIO ENGINEERING DEGREE IN 27 MONTHS

Radio engineering is a big field. There's room for you in it—if you're good. Get first-class training at Indiana Tech. Intensive specialized course, including strong basis in mathematics and electrical engineering, advanced radio theory and design, television, electronics. Modern laboratories. Low rate. Also **B.S. DEGREE IN 27 MONTHS** in Aeronautical, Chemical, Civil, Electrical and Mechanical Engineering. G.I. Government approved. Enter December, March, June, September. You can earn part of your expenses right here in Fort Wayne while you are studying.

INDIANA TECHNICAL COLLEGE
913 E. Washington Blvd., Fort Wayne 2, Indiana

Please send me free information on B.S. Engineering Degree in 27 months as checked.

Radio-Television
 Civil Mechanical Aeronautical
 Electrical

Name _____
Address _____

ATR

Makes
it easy
to DEMONSTRATE
AND TEST
D.C. APPARATUS
FROM A.C. LINES



"A" BATTERY ELIMINATORS

For DEMONSTRATING AND TESTING
AUTO RADIOS

New Models . . . Designed for testing D.C.
Electrical Apparatus on Regular A.C. Lines.
Equipped with Full-Wave Dry Disc Type
Rectifier, Assuring Noise-less, Interfer-
ence-Free Operation and Extreme
Long Life and Reliability.

ATR

- ✓ NEW MODELS
- ✓ NEW DESIGNS
- ✓ NEW LITERATURE

"A" Battery Eliminators, DC-AC Inverters
Auto Radio Vibrators

See your folder or write factory

AMERICAN TELEVISION & RADIO CO.
Quality Products Since 1931

SAINT PAUL 1, MINNESOTA-U.S.A.

Among the subjects included on the agenda were the technical requirements and standards for theater TV, involving the video signal (bandwidth, signal-to-noise ratio, linearity of electrical transducers and standards); audio signal; and the radio-frequency transmission of the video signal (r.f. bandwidth per channel, allocation principles for co-channel and adjacent channel operation, number of channels required per system, summary of standards, technical limitations on choice of frequencies, and possible location of theater TV service in spectrum). Also up for review were the possible systems of microwave distribution which might be used for intercity relay, intercity multiple address and intracity distribution. Methods which might be employed for projection were also up for analysis, kinescope projection, film storage, and *Eidophor*. Costs were also debated.

Quite a slice of the spectrum was asked for by the motion picture interests; a 360-mc. band in the 5925-6875 megacycle range, a band now allocated for fixed common carrier services. To assure quality transmission of 35-mm film, film engineers said that the FCC should provide 10-mc. wide video channels, radio-frequency channels 30-mc. wide, two-channels for a single system, and room for six systems for competitive reasons. It was also noted that an additional 60-mc. would be required for mobile pickup services. The Commission was told that if the channel initially requested could not be set aside, then there were two alternatives. Theater TV could be reclassified as an industrial service and be allowed to operate in the 6575-6875-mc. band, with the band being widened to accommodate the necessary 360 megacycles, which would mean that the industrial service band would have to be extended down to 6425-mc. The second possibility lay in the allocation of the band at 10,700-11,700 megacycles, now also assigned to fixed carrier circuits. If this microwave band were used, then radio-frequency channels of 55 megacycles would be required, instead of 30-mc. stated in the original specifications.

Theater TV may require an entirely new set of standards, it was disclosed at the meeting. Recommended for such a new engineering setup were a scanning rate of 735 lines; a signal-to-noise ratio of 46 db for black and white, and 42 db for color; a frequency-modulated video signal, an 8-ke. wide audio signal, multiplexed on the carrier, and a linearity not to exceed 10 per cent variation between the black and white levels.

The cost of building an intercity and intracity microwave net covering nine cities and about 1500 theaters between New York and Washington was estimated at between fifty- to sixty-million dollars, while operational expenses would run to about \$2-million.

The fear that theater TV would deprive home viewers of top-flight pro-



THE FAMOUS WILLIAMSON AMPLIFIER FOUNDATION KIT

1 Power trans. 810 volts CT @ 225 mls. 0.3v @ 8 amps. 5.0v @ 3 amps. \$ 6.95
2-10 Mid 600 volt oil cond. with brackets. 2.28
1-12 Hvy 250 mil choke 70 ohms. 2.95
* 1 Hi fidelity Chicago output tube.
Schematic included. Value \$45.00.
OUR VERY LOW PRICE. \$15.99
* Available only in kit.

POWER TRANSFORMERS

WESTINGHOUSE Pri. 115v 50-60 cy. Sec. 600v c.t. @ 250 mls; 12.6v c.t. @ 5 amps; (6.3v @ 5 amps; 0.3v @ 5 amps) 5v @ 3 amps. Electrostatically shielded. Brand new. **\$4.49**

STANCOR: Pri. 110v. 125v. 50-60 cy. Sec. 900v c.t. @ 325 mls; 6.3v @ 5.5 amps; 0.3v @ 4.5 amps; 5v @ 6 amps. upright mt. Ship. wt. 2 1/2 lbs. Reduced to. **\$8.95**

RCA: Pri. 115v. 50-60 cy. Sec. 750v c.t. @ 225 mls; 6.3v @ 8 amps; 0.3v @ 1.2 amps; 5v @ 3 amps. Half-shell mtg. Shih. Wt. 13 lbs. Reduced to. **\$5.99**

10 MFD-600V OIL CONDENSERS
Sprague and C.D. Blant. 23 3/4" Height: 3 5/8" (99c ea. Brackets 15c ea.)
Complete with brackets. **3 for \$2.95**

KIT OF 100 RESISTORS
Consists of popular 1/2 and 1 watt resistor values. Made by leading manufacturers—All Standard Brands! **\$2.99**

FP CONDENSER KIT
8 condensers, assorted. All new, standard sizes. Single & multi-sections. Complete with \$2.95 mounting plate. \$12 value. **\$2.95**

4 1/2" SQ. 0-200 MICROAMP MULTI-METER
Made specifically for VTVM. Following scales: ohms, d.c. & a.c.; 0-3, 0-10; d.c. 0-3, 0-10. **\$9.95**
Famous make.

630 SUPER DELUXE 31-TUBE TV KIT
Complete, including voltage doubler and AGC. For all tubes 16" to 24". Less CRT & wire. **\$119.44**

PHOTO FLASH CONDENSERS
Cornell Dubilier. 100 mid. @ 450 volts. 2 condensers. 80 watt seconds. **\$5.95 ea.**
Very special

BATTERY CHARGER
115v 50-60 cy. 6 amp. Charges at 6 amp rate; tapers to 3 amp. Complete with 2" meter. 7" high, 4 1/2" long. **\$8.95**
4" wide

SLEEPER SPECIALS!!

2 1/2" Simpson HP 0-8 ammeter. Built-in thermocouple ea. **\$2.69**

Choke: 10 HY; 85 mls; hermetically sealed 400 ohms d.c. 49c ea. **3 for \$1.35**

GE 2 meg. volume control. ea. 35c
3 for \$1.00

TERMS: 20% cash with order, balance C.O.D. unless noted. Prices F.O.B. our warehouse in N. Y. C. Minimum order \$3. NOTE: Due to conditions beyond our control, prices are subject to change.

Phone Worth 4-3270
ACORN ELECTRONICS CORP.
76 Vesey St., Dept. T-1, New York 7, N. Y.

EQUIPMENT NEEDED!
BC-348, BC-342, ART-13
I-152, BC-788, BC-611

Also interested in other airborne electronics. Top dollar paid. Inquiries answered promptly.

V & H Radio & Electronic Supply Co.
2033 W. Venice Blvd. Los Angeles 6, Calif.
Phone: REpublic 3-1127

LEARN TELEVISION

ELECTRONICS and RADIO
Engineering Laboratory and Classroom Training. Day and Evening Classes.

Write for illustrated Catalog

ELECTRONICS INSTITUTE, Inc.
21 HENRY, DETROIT 1, MICH.

grams was discounted by spokesmen for the film exhibitors and producers. Only special presentations, prepared for theater audiences and particularly adapted to large-screen reproduction, would be offered, the film moguls declared.

Complete briefs on behalf of others who will be involved in this new form of videocasting will be offered during the first weeks of the new year, and an extensive cross-examination period will follow. In view of the complexities of the issues involved in theater TV, many believe that there'll be no final decision from the Commission for quite awhile.

LOUDSPEAKER MANUFACTURERS have been cautioned by the NPA against a quick return to the production of electromagnetic speakers, in view of the present uncertainties in the copper supply situation.

The steel situation, disturbed by the recent strike, was also posed as a current difficulty by the government. Both issues were presented at a special meeting in Washington. In reply, an industry committee reported that speaker manufacturers are faced with a problem of seasonality and tie-in with radio and TV production. Declaring that loudspeaker steel allotments for the fourth quarter of '52 and advance allotments for the first quarter of '53 have been inadequate, manufacturers stressed that these quarters are the period of highest demand for their products. It was pointed out that speakers are the last component to be incorporated in chassis, and thus set makers do not order far in advance of their peak selling season. Therefore, it was noted, the speaker industry loses civilian business if it does not have a concentration of production material in the fourth and first quarters.

NPA officials stated their awareness of the situation and desire to alleviate the problem as soon as defense needs for steel are met.

Among those who attended the conclave in the nation's capital were H. S. Morris (Altec Lansing), George Cromartie, Jr. (Best), Austin Ellmore (Crescent Industries), Russel S. Fenton (Permosflux), Matt Little (Quam-Nichols), Stuart W. Bell (Quincy), A. I. Abrahams (Racon) and Laurence A. King (Rola).

THE SIZZLING AM-BAND EXTENSION debate has finally come to an end. A few weeks ago the Commission issued a finalized rule approving the use of the 540-kilocycle band. The AM broadcast band now extends from 535 to 1605 kc, instead of from 550 to 1600. The extension of the band had been approved at the Atlantic City conference in '47, and on December 1 of this year the extension had been officially supplemented by a Geneva agreement.

For years, broadcasters have been trying to win approval of this band, but were told that this channel was

FOR THE BEST COVERAGE

IT'S THE

RADIO HANDBOOK

GIANT 13TH EDITION

Whatever your position in the radio and electronics field . . . technician, engineer or advanced amateur . . . you'll find the answers you are seeking in the new **RADIO HANDBOOK**. This great clothbound, gold stamped one-volume encyclopedia of radio information is the largest **RADIO HANDBOOK** ever published . . . and the best!

Reference data galore, the latest in theory and practice; profusely indexed, clearly illustrated. All the information you *must* have, where you can find it quickly.

Order your **RADIO HANDBOOK** now from your favorite dealer. You can't afford to be without it . . . and it costs you less than one cent a page!

734 PAGES **\$6.00** PER COPY (plus tax)



FOR ADDITIONAL COVERAGE

BETTER TV RECEPTION in fringe and low-signal areas. **NEW SECOND EDITION** just off the press. The standard guide for installation engineers and TV owners. **\$2.50**

ANTENNA MANUAL. 300 pages of help on antenna, feed line, radiation and propagation for all frequencies up to 1000 Mc., including FM and TV. **\$3.50**

WORLD'S RADIO TUBES (Brans' Vade Mecum) New 9th edition. The only book which includes **ALL MAKES OF U. S. TUBES** and all foreign. Available in 16 languages. **\$5.00**

RADIOTELEPHONE LICENSE MANUAL. Complete study guide questions with clear concise answers, for all U. S. A. commercial radiotelephone operator's exams. **\$3.75**

SURPLUS RADIO CONVERSION MANUAL in 2 volumes. Conversion data for most common items of surplus electronic equipment. Write for list. . . . Each volume **\$2.50**

BUY FROM YOUR DISTRIBUTOR

AT PRICES SHOWN, OR ADD 10% ON DIRECT MAIL ORDERS TO EDITORS and ENGINEERS, Ltd., 1302 KENWOOD ROAD, SANTA BARBARA, CALIF. Bookstores order from BAKER AND TAYLOR CO., Hillside, New Jersey

WORTH 5 TIMES THE PRICE! REMOTE CONTROL UNIT

ELECTRONIC THYRATRON THERMOSTAT CONTROL THAT USES A PLATE CIRCUIT TRIGGER RELAY!

A most outstanding value! . . . an electronic unit that not only can be changed over to serve many purposes but is loaded with valuable standard component parts for anyone who knows value and wants to buy them for the parts alone . . . the relay alone is worth the price we're asking for the entire unit . . . check the list below.



249 POSTPAID

COMPLETE WITH CABINET

10 UNITS
\$22.39

TERRIFIC BUY!

FITS INTO MANY USES

DON'T PASS UP THIS OPPORTUNITY FOR ONLY

- 1—115V-6.3V Filament Transformer
- 1—S.P.S.T. Sensitive Plate Relay
- 6—Carbon Resistors
- 7—Wire Wound Resistors
- 1—S.P.S.T. Switch
- 6—Paper Tubular Condensers

MANUEL KLEIN CO.

- 1—Electrolytic Condenser
 - 1—Potentiometer
 - Plastic Cabinet—5 1/4 x 5 x 3 1/4
 - 3—Tube Sockets
 - Pilot Lamp, Dial Assembly
 - Knobs, Feet & Assorted Hardware
 - Schematic Diagram
- 94 Chambers St., New York 7, N.Y.
REctor 2-6460

HOW FAST you work

HOW WELL you work

HOW MUCH money you make

... depends a whale of a lot on your ability to

Use ELECTRONIC TEST INSTRUMENTS effectively!

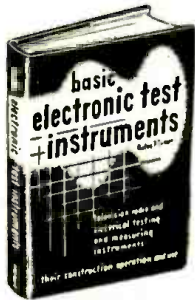

Here at last is a complete line-up of how-to-use-it data on ALL TYPES OF MODERN SERVICE INSTRUMENTS!

In complete, easily understood terms, you learn all about over 60 different instruments. You are shown exactly when, where, why and how to use them—on all kinds of service jobs.

You discover how to use familiar instruments more fully.

And you gain a first-hand working knowledge of the many newer types such as grid-dip oscillators, TV sweep and marker generators, TV linearity pattern generators, distortion meter, square wave generators and others that are so essential in servicing today's complicated equipment.

BASIC ELECTRONIC TEST EQUIPMENT
by Rufus Turner
New and completely revised edition 233 pages, 6 by 9. Price \$4.00.

Everything you need to know
about ALL instrument types used in modern Radio-TV service:

1. Simple Meters for Current and Voltage
2. Ohmmeters and Volt-Ohm-Milliammeters
3. Vacuum-tube Voltmeters
4. Power Measurement & Meters
5. Impedance Meters & Measurements
6. Capacitor Checkers
7. Inductance Checkers
8. Special-purpose Bridges & Accessories
9. Oscilloscopes and Their Uses
10. R-F Test Oscillators & Signal Generators
11. Audio Test Oscillators
12. Measuring Radio Frequencies
13. Measuring Audio Frequencies
14. Audio-Amplifier Testing Devices
15. R-F Signal Tracers
16. Tube Characteristics & Tube Checkers

WHAT INSTRUMENT TO USE... HOW TO USE IT PROPERLY

To the beginner, BASIC ELECTRONIC TEST INSTRUMENTS offers complete training in modern instrument usage. To the more experienced serviceman, it is a handy reference book that can more than pay for itself in time saved on a single job. Each subject is covered from a practical service standpoint—NOT just as an instrument manufacturer's instruction manual. You learn the limitations of each instrument as well as its advantages! 171 photos, data tables and schematics help make things as clear as A-B-C.

And here are some of the book's EXTRA "how-to-do-it" features: How to measure resistance with a current meter; how to check power drain easily and quickly; how to measure R-F impedance with a simple T-network; how to check frequency with a scope; how to calculate a shunt or multiplier; how to calibrate meters. . . and dozens of other subjects.

Read it for 10 days at our risk! Clip 10-day examination coupon and send to: Rinehart Books, Technical Division, Dept. RN-13, 232 Madison Ave., New York 16, N. Y.

10-DAY FREE EXAMINATION

Dept. RN-13, RINEHART BOOKS, Inc.
Technical Division, 232 Madison Ave.
New York 16, N. Y.

Send Turner's BASIC ELECTRONIC TEST INSTRUMENTS for 10-day FREE EXAMINATION. If I decide to keep book, I will then remit \$4.00 plus postage. Otherwise I will return book postpaid promptly and owe you nothing.

Name.....

Address.....

City, Zone, State.....

Employer's Name & Address.....
OUTSIDE U.S.A.—Price \$4.50, cash only.
Money back if book is returned postpaid in 10 days.

too close to frequencies used by the government and marine services. However, the marine services have now arranged for the adoption of higher standards for auto-alarms* on ship-board, and the interference difficulty which prevailed earlier will no longer be a problem.

Canada has been using 540 kc. as a clear channel for many years, and XEWA, San Luis Potosi, in Mexico, is also operating on this band, with a power of over 100 kilowatts.

The first American station to use the new frequency may be KMBC, at Concordia, Missouri, who has been seeking that channel for years.

COMPATIBLE COLOR TV, as developed by the National Television Systems Committee, is expected to be ready for submission to the Commission next summer, according to Art Loughren, vice prexy of Hazeltine and chairman of the color video standards committee of NTSC.

The forecast was made during a meeting of the Society of Motion Picture-TV Engineers in Washington recently.

Before the FCC receives the petition to review the new color system, industry will be asked to review carefully, during a series of tests, all of the aspects of the system on the receiving as well as transmitting fronts. Then, one company will enter a plea for a hearing; NTSC will not be able to request the hearing since it represents most of industry and its views would probably be judged as biased, and thus not admissible before the Commission.

A FLEET OF 26 aircraft, operated by the Swiss Air Lines, will soon have complete visual omni-range very-high facilities for communications. The system features the use of instrument-panel navigation and is said to be useful on any course up to 200 miles to or from an airport.

* Auto-alarms serve to sound a call when a signal is received on 500 kc.

The airlines, operating out of Zurich, Switzerland, serve principal European points, the Near East, and provide transatlantic flights to New York City.

THE COUNTRY lost one of its foremost broadcasting legislators during the late fall, when Harold A. Lafount, member of the former Federal Radio Commission, died.

As a crusading Commissioner, he sought means to improve reception through the use of higher power for key outlets. Over twenty years ago he studied the possibilities of TV development.

The nation will miss the talents of this pioneer whose mature wisdom played so vital a role in creating the sturdy base on which modern broadcasting is built today. . . . L.W.

International Short-Wave (Continued from page 86)

To Central Europe, United Kingdom 0230-0330, 17.705, 15.160; 0345-0415, 17.850, 15.160; 1000-1030, 11.780, 7.250. To East, Southeast Africa, Mauritius 2300-0010, 17.705, 15.130, 11.870; 1045-1215, 15.290, 11.780. To Burma 1945-1955, 9.720, 7.170; 0615-0700, 17.850, 15.160. To China 0430-0545 (to only 0530 Sat., Sun.), 17.850, 15.160; 0530-0600 (Sat., Sun. only), 17.850, 15.160. To Indonesia 1745-1800, 7.125, 5.960; 0700-0730, 17.850, 15.160. To Fiji 0200-0320, 21.700, 15.190. To West Indies 1830-1930, 11.850, 9.630, 7.170, 5.980. To Pakistan 2245-2320, 9.630, 7.125, 5.970; 0745-0815, 5.990, 3.945; 0815-0915, 7.170; 0945-1000, 3.945. To Afghanistan and adjacent areas 2215-2230, 7.125, 5.960; 0845-0930, 3.945. To Afghanistan 0030-0130 (Fri. only), 9.670, 7.170; 1130-1230, 7.170, 5.980, 4.940, 3.945. To Persia, Afghanistan 1230-1330, 7.170, 5.980, 4.940, 3.945. To Saudi-Arabia, Egypt, Lebanon, Syria, North Africa, Jordan, Sudan 2330-0030, 11.760, 9.720; 1230-1430, 7.125, 5.960. To Europe, United Kingdom 1445-1545, 11.780, 9.565, 7.115.

DON'T PASS THIS BUY

GOOD VALUE MARINE BAND RADIO RECEIVERS AT LOW COST—UNITS REMOVED FROM POLICE RADIO CARS, used but in good working condition, fixed tunable in 2-3mc band. Complete with 5 tubes, speaker & 6 volt input power supply. Also suitable CD. AUXILIARY POLICE-FIRE SERVICE. As is W money-back guarantee. Wt. 25 lbs. \$14.95

ARMY SURPLUS SECTIONAL STEEL WHIP ANTENNAS 12 1/2 ft. \$1.85; 18 1/2 ft. \$2.50; 24 1/2 ft. \$3.35

IDEAL 20-40 meter Vertical dish, 22 1/2 ft. 4.65

HINGED TYPE INSUL. MTG. BASE, IDEAL low bridge loss type of mtg. Used W above units. 7.95

BRAND NEW MFD 6 V. BATTERY CHARGERS. Keep your battery in good cond. during winter

JAEGER 6 V. DC CLOCK (made for Kaiser-Frazer)

5" Dia. W 2 panel lamp, draws 3ma will run on dry cells, made to sell for \$17.00, only 5.95

VIBRAPACK, 6 V. In. 250V/100 ma HD used. 6.95

CARTER DYNAMOTOR, same specs as above. 6.95

COMPACT ELTRON VIBRATOR PACK, 6V. In. 90V/200 ma will operate on 4 D cells, 2 1/2 dia. x 3 1/2 H. 3.95

YOUR NEW RADIO CONTROL PARTS HEADQUARTERS

CRYSTALS, 27.25mc. (.04 tol., FCC) strong 3rd harmonic oscil. newly mfr'd to our specs. \$4.25

XFO-1, that hard-to-get Zenith tube. 3.35

3A4, 85c; 3A5, \$1.35; 3V4, \$1.40; 184, 1.65

SIGMA 41F relay, 10,000 ohm .03 watt sensit. 2.45

SIGMA 5F relay, 100 ohm resist. 10,000 ohm, a 2.95

SIGMA 5F relay, 5000 ohm super-sensitive, 4 to the ideal relay for your receiver, special. 6.95

GENERAL ELECTRIC miniature 10,000 ohm, a light unit suitable/hard tube receivers. 2.45

RECEIVER PARTS KIT, W/3A4 & G.E. relay above. 5.95

TRANSMITTER PARTS KIT, W/3A4 tube & crystal 8.95

MONEY BACK GUARANTEE ON ALL ITEMS Save G.O.D. Fees, Incl. Postage. Excess Refunded Minimum Order—\$3.00, Please

Special Bonus—2 lb Hookup Wire Kit Free \$5 Order

ELECTRONIC SPECIALTY SUPPLY CO.
58 WALKER STREET, NYC 13, N. Y. WALKER 5-8187

SUPER VALUE!

0-1 MA DC 4" SCALE

Only \$5.95 ea.

2 FOR ONLY \$11.00

Greatest meter value ever offered! Sensitive 1 MA DC basic movement may be used for any type of current or voltage meter. Big 4" scale calibrated 0-1 for easy fractional readings. Rectangular bakelite case with corner mounting holes mounts flush on panel, projects 2" forward. Nothing behind panel except meter terminals. Meter case measures 4 1/2" high, 5 3/4" wide. These meters are slightly used but have been thoroughly checked and reconditioned. We guarantee them for absolutely top performance. Don't delay; order now! No more available after present supply is sold!

25% with order—
balance C.O.D.—F.O.B. Chicago

NATION WIDE RADIO
572 W. Randolph Street Chicago 6, Ill.

To W. Europe, N. Africa, and the Levant 1445-1530, 5.960, 7.125. The English news service is 1500, 11.780, 9.565, 7.115; 1930, 11.850, 9.630; 2310, 17.705, 15.130, 11.870; 0300, 17.705, 15.160; 0830, 15.190, 11.780; 1045, 15.290, 11.780.

Indo-China (Vietnam)—Radio France-Asie, 9.954AV, Saigon, noted ending English session with "Knights-bridge March" 1754. (Pearce, England) This one is at fair level some days around 0740. (Stark, Texas) Heard on 15.430 with English session 0500. (Sanderson, Australia) "Voice of Vietnam" is noted on 7.2882 and 9.620 with English 0930-1000 closedown; schedule is 1800-1930, 2215-0030, 0500-1000. **Radio Hue**, 7.205, is now scheduled 1830-1900, 2300-0015, 0500-0800. **Radio Dalat**, 7.265, broadcasts 0530-0630 (Sat. 0630-0700) in French. **Radio Hanoi** is now on 9.670 at 1800-1900, 2230-0015, 0500-0830. **Radio Hirondelle (Swallow Radio)**, "Voice of the French Army in Indo-China," broadcasts on 7.408 from Hanoi at 2300-0130, 0530-1000, all-French. **Radio Laos**, 7.215, broadcasts news in French 0800-0815. **Radio Cambodia** relays French from Saigon 1815-1845 on 6.090, has its own news in French 0700. (Wada, Japan)

Israel—Tel-Aviv, 9.009A, now has news 1515; has English session ("Voice of Zion," relayed from Jerusalem) now 1615-1700 closedown. Announces news for 0645 over 6.830, 9.000 (actually 9.009A); has "Voice of Zion" session in French 1530. (Pearce, England; Martin, R.I.)

Italy—Rome, 9.630, noted opening 1245 and announcing for 9.63, 11.81; had news for Great Britain. (Ferguson, N.C.)

Jamaica—Radio Jamaica, 4.950, Kingston, noted opening 0600. (Ferguson, N.C.) And closing 2300 on 3.360. (West, Va.)

Japan—JKI4, 11.800, Tokyo, relaying Home Service, is strong level in New Zealand 0400; before 0345 has had QRM. (N. Z. DX Times) **JBD4**, 15.235, noted 0400 with program in Japanese and Western music; is "N.H.K." outlet **JK16**, 11.825, noted 0400 with world and local news, then music. (Sanderson, Australia) **JKL**, 4.860, noted 0850 with popular music; **JKI**, 4.910, heard 0830 in Japanese, along with **JKM**, 4.940. (Flynn, Calif.) **AFRS**, 4.860, is noted in English to 1000 sign-off. (Gaylord, Wn. State) **Radio Japan** now uses **JOA3**, 9.675, and **JOB**, 6.069, to North America 0000-0100; the 0600-0700 beam to North China is radiated over **JOA2**, 7.180, and **JOB**, 6.069. Other transmissions are unchanged. (Kary, Pa.)

Kenya Colony—VQ7LO, 4.852, Nairobi, is now on this measured frequency, heard from 1200 to close 1500; the South African Broadcasting Corporation says Nairobi is also using 6.060 in parallel. (Ridgeway, South Africa) **Forces Broadcasting Service**, East Africa Command, 7.265, Nairobi, noted with music 2248; has BBC news relay 2300. (Ferguson, N.C.)

Lebanon—Beirut, 8.036A, has Eng-

HAPPY NEW YEAR; WE SAY IT WITH BARGAINS!

A SENSITIVE RELAY!

Closes at 4 to 5 ma. (Extra set of SP/ST contacts for additional sequence, close at 6.5 ma.) Coll. 8000 ohms. Sensitivity easily altered by bending limit arm or changing spring. Only 1 1/2" x 2 1/2" x 1 1/2" overall. Dozens of applications, and offered at a "stock up" price. Removed from clean equipment. **ONLY 98c each, 3 for \$2.75**
Boxed, reconditioned, like New. **NEW, \$1.69**

SUPER SENSITIVE RELAY SCOOP!

8K-7, fully enclosed and adjustable. Single pole, double throw, fully adjustable contacts with dial calibrated spring. Will operate at low as 1.5 ma! In plastic case, 1 1/2" x 3" x 1" deep. **ONLY \$1.95 each, plus 15c mailing charge or 10 for \$17.50, postpaid anywhere in U.S.**

HEAVY DUTY RELAY

40 amp contacts starting relay. SP/DT, normally closed one side. **NEW, \$1.95; 3 for \$4.95**

PRECISION CALIBRATED TUNER

Build a Q-meter or an audio oscillator, a signal generator, a VFO, an ultra-stable receiver, or... you name it! Last-standing accuracy and restability. 3-gang condenser assembly with 4" precision dial etched. 1.5-12 mc in 3 bands plus a reference scale. Triangular plastic hairline indicator. 50:1 ratio drive assembly, all gears spring-loaded for protection. Has tuning lock. Plates are two single spaced 250 uuf, and one double-spaced 260 uuf section. Use double spaced section to eliminate drift. **ONLY \$4.95**

BROADCAST BAND & AERO

MN-26-C Remote Controlled navigational direction finder and communication receiver. Manual DF in any one of three freq. bands. 150 to 1500 KC. 24 V. Self-contained dynamo supply. Complete installation, including receiver, control box, loop, azimuth control. Left-Right Indicator, plugs, loop transmission line, and flex. shafts. BRAND NEW, ORIG. PACK. \$69.50

SUPER HI-FI HEADSET BUY!

Uses annular-grooved plastic fibre cones with voice coils in speakers, and padded chamois ear muffs to obtain spacing for correct acoustical load. Gives finest music reproduction, flat far beyond upper and lower limits of auditory perception. Pair in series has means for impedance of 600 ohms to 6000 cycles, obtained with built-in high quality transformers. However, severe mismatching makes no apparent difference. Far superior to crystal phones. Manufacturer's net price is \$45.00 per pair! (Each unit can also be used as high quality dynamic mike with 300 ohm output impedance.) They come to you checked out with freshly laundered chamois pads in cellophane bag. **ONLY \$7.95**

PORTABLE POWER KITS

1. Includes 2 volt, 20 Ah wet cell, lightweight transparent plastic, fibrite separator, 3 ball dynamometer, 4" x 3" x 5 1/2" high, shipped dry; also 2 volt synchronous vibrator, no tube needed; also 2 volt charger, 115 v, 50/60 cy in. This high quality unit gives closed-down transformer and dry disc rectifier, with pilot lamp in output to indicate and regulate charging rate. With eyedropper type battery filler and instructions. **ALL 4 ITEMS, BRAND NEW. \$4.95**
2. Six volt Vibrapak kit. Vibrator plus non-synch transformer with two outputs, 345 v, 145 ma for plates. 15 v for bias. With schematic. **BRAND NEW \$2.95**

TRANSFORMER SPECIALS

THERMADOR 5A-1225 POWER TRANSFORMER. PRT: 115 v, 50/60 cy. SEC: 600-410-0-410-600 v, 250 ma; 6.3 v, 3 A; 6.3 v, 3 A; 7.0 v, 3 A. Type "A", fully enclosed. Ideal for portable ham rigs. Gives almost perfect. New manufacture, guar. 1 year. Only \$10.80
THERMADOR 5A-7220 POWER TRANSFORMER. PRT: 115v, 50/60 cy. SEC: 370 v CT, 250 ma, 0.3v, 3A, 6.3v, 3A, 5.0v, 3A. Same as above, ship wt. 12 lbs. Only \$7.95

12 V FILAMENT TRANSFORMER or line voltage booster. PRT: 110 v, 60 cy.; SEC: 0 to 12 volts in 1 volt steps at 3 A. Free schematic shows many uses. **NEW \$1.89**
6 V VIBRATOR TRANSFORMER. Non sync, two outputs: 345 v, 145 ma for plates; 15 v. **NEW \$1.89**
OUTPUT TRANSFORMER. 5000 ohms input to TWO outputs: 300 ohms or 3.5 ohms. Use as output for 12A6, 6X4, etc. or to match speaker or headset. **NEW, potted, shielded. 79c**
THERMADOR SMOOTHING CHOKE 7A-1225, 12 H, 250 ma. \$6.90
THERMADOR SWINGING CHOKE 7A-5250, 20 H, 250 to 25 ma. (Shipping wt. on these chokes—11 lbs.) \$6.90

12 CHANNEL T-V TUNER

Complete front end, famous make "Silver Circle." Furnished with original factory instructions, less tubes. Dozens of uses; receivers, converters, etc. The TV bargain of the year for builders, amateurs, students. These are factory rejected for minor damage, but all easily repairable. **ONLY \$1.95 each, 3 for \$5.00**

RF AMMETER, 0-4 amps, 2" round, thermocouple type. Has 1" scale—spread between 1 and 3 amp. NEW \$3.95

NOVICE 80 METER CW XMTR

Here's a neat and compact surplus item which converts very simply to 3700-3750 KC crystal controlled. Guaranteed suitable. Instructions? Yes, we furnish them! Complete, comprehensive, step-by-step; nothing left to guesswork. This is 5-3-7, the command transmitter which has been such a favorite with old-timers. **ONLY \$7.95**

NOVICE 2-METER VOICE XMTR-RCVR

ARC-4. A standard for two meter conversion. Excellent used, all tubes, conversion instructions. (The tubes alone are worth more than \$30.00 at surplus prices!)

Less dynamotor **\$37.50**
12 or 21 volt ARC-4 dynamotor **\$42.50**
TUBE GRAB BAG. At least 10 tubes of special interest; new types, old types, big ones, little ones; some new, some used but good. A big value at **\$1.39**

4 USES—4 DOLLARS

The most versatile dynamotor in surplus! The best dynamotor for conversion in 4 v. Multiple windings! After conversion you get choice of 900 or 350 v at 30 MA or 250 v at 100 MA. No brushes to shift around, no mechanical work. Or use it as a 2:1 or 1:2 step-up or step-down transformer for DC voltages. Changes 6 to 12, or 12 to 24, or vice versa, up to 3 A. Or use it as a GENERATOR. Turn with motor, get 12 v DC at 12.6 A or 24 v DC at 6.3 A. Plus high voltage. Includes easily removable self-contained 800:1 sealed-oil gear reduction unit. Complete dope sheet **\$4.00** furnished. **BRAND NEW**

PE-103 SPECIAL. A standard mobile dynamotor power supply. Delivers 500 vdc, 0.16 amp. Complete with filter base, relays, input cables, and instruction sheet. **LIKE NEW \$24.50** (Shipping weight 75 lbs.)

COMMAND EQUIPMENT

With free dope sheets and schematics

RECEIVERS
BC-455, 6-0 mc. NEW \$12.95, GOOD USED. \$7.95
BC-455, 6-0 mc. NEW \$12.95, GOOD USED. \$7.95
T-19 ARC-5, 3-4 mc. Excellent. \$14.50
RC-20, ARC-5, 4-5.3 mc. Like new. 8.95
MOD RC-456, Brand new \$5.95. Excellent used. 2.49
As is, for parts, **1.19**
274N PLUG. 7-prong male plug to fit back of command racks. NEW, each 21c; five for **\$1.00**
Local Control Adapter Parts for 274N or ARC-5 revr. Exact, hot switch, knobs, etched plate, and instruction data. Ready to mount. **\$1.29**

12 VOLT COMMAND DYNAMOTOR

For receivers RC17-274N, ARA, ARC-5. Plugs onto rear end. 250 V, 60 ma. DY-1/ARR-2V. **\$7.95**
Guaranteed good condition **5.95**
Less plug-in **\$1.00**

A VIBRATOR BUY. 6 or 12 volt, self-rectifying, hermetically sealed. Can take high overloads. With socket and schematic. Specify yours. **ONLY 89c**

ANTENNA MAST SECTIONS, MS-10, 50, 51, 52, 53. New, original packing. **Each \$1.39**

AUDIO SUPER-SPECIALS

SUPER HI-Q high cut choke. 0.65 H, 55 ohms DC. Tune with 001-0004 MF. **ONLY 98c**
LOW CUT, 5 H, 284 ohms. Tune with 1 MF. Or use as 30 ma filter choke. **ONLY 98c**
OUNCER Transformers, one for mike to push-pull grids, fit 50 to 15,000 CPS; other for push-pull output, tapped sec., turns 1:1 in unit with resistors, condensers, etc. **BOTH FOR ONLY \$1.29**
PHASE SPLITTER, or low-level mixer, or hybrid, or push-pull unit. Has 3 windings, each exactly 1:1 to any other; essentially flat 100-15,000 CPS. **89c**
BRAND NEW, ONLY \$1.29
VINYLLITE SPAGHETTI, clear, 0.108 ID, three 257 lengths for only **96c**

BUILD TV-FM-AM SWEEP GENERATOR

(See Dec. Radio & TV News)
Now you can build the "VERSATILE SWEEP FREQUENCY GENERATOR" We've got a few more of those vinyl SPN-1 magnetic units, with reprint of the article. **\$6.95**

EASY MONEY!

We're still buying surplus gear. Tell us what you've got, its condition, and your price. If we like it you'll get our check quick.

G. L. ELECTRONICS 905 S. VERMONT AVE. LOS ANGELES 6, CALIF.

ALL PRICES F. O. B. LOS ANGELES. CALIF. BUYERS ADD SALES TAX

ATTENTION

Distributors in Chan. #12 Territory

We are in production on 5, 10 & 12 Element—most efficient YAGI ever designed. MANY TERRITORIES STILL OPEN. We Welcome your Inquiries. ALSO COMPLETE LINE OF THE ANTENNAS.

FRENCHY RADIO MFG. CO.

164 W. Parker St. Scranton 8, Pa.

Advance with ELECTRONICITY

You need firm grasp of fundamentals to keep pace with these complex, fast-growing fields. In through 2-year course learn electricity, electronics, physics, mathematics, drafting, etc. Other engineering and technical courses. Coed. Day, evening, 45th year. Write for Catalog.

FRANKLIN TECHNICAL INSTITUTE
46 Berkeley Street Boston 16, Mass.

GET INTO ELECTRONICS

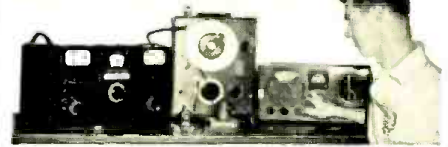

You can enter this uncrowded, interesting field. Defense expansion, new developments demand trained specialists. Study all Phases radio & electronics theory and practice: TV; FM; broadcasting; servicing; aviation, marine, police radio. 18-month course. Graduates in demand by major companies. H.S. or equivalent required. Begin Jan, March, June, Sept. Campus life. Write for catalog.

VALPARAISO TECHNICAL INSTITUTE
Dept. RD Valparaiso, Indiana

World's most powerful
TV ANTENNA!

22 Db gain
over tuned dipole!

- GUARANTEED 10 times more powerful than stacked 10 element Yagis.
- GUARANTEED to extend fringe area reception an additional 40 miles.
- Motorless All Direction reception — nine different antennas in one.
- Broad band UHF — VHF plus FM reception.
- Half the cost of single channel stacked Yagis — Patented to insure price protection, U. S. Pat. Nos. 2,585,670 — 2,609,503, others pending.
- Pre-assembled, quick-rig, flip-out.
- Nationally advertised.

The only TV antenna that instantly beams the television set directly to the signal without a rotor.

The biggest antenna news of the year. TV technicians are marveling at this amazing powerful high gain antenna. The only antenna that brings strong signals from all directions to weak signal areas instantly . . . with a flick of the nine position switch located near the TV set.

Individually packaged with complete instructions

\$36⁵⁰ LIST PRICE

Includes Stacked Antenna Array, 9 Position Switch, Completely Wired Stacking Harness, A.I.M.—Automatic, Impedance Matching Coupler.

MONEY BACK GUARANTEE
To outperform any present day antenna array using a rotor motor, including stacked 10 element Yagis array, 4 bay conicals, fans, double Y's, etc.

Available at local jobbers, or write for name of nearest representative

ALL CHANNEL Antenna Corp.

70-07 Queens Blvd., Woodside 77, N. Y.
Hickory 6-2304

lish daily 1000-1100A. (Pearce, England) Noted signing off 1631. (Kary, Pa.)

Liberia — ELBC, 6.022, Monrovia, noted 1830 to 1845 sign-off; announced would be back 1025. (Ferguson, N.C.)

Madagascar — Tananarive, 9.515, noted opening 2230 with "La Marseillaise." (Bellington, N.Y.; Kary, Pa.)

Malaya—Radio Malaya's Blue Network, 7.200, Singapore, noted signing off 1030 with "God Save the Queen;" on a Saturday was noted to 1100 closedown. (Pearce, England) Kuala Lumpur, 6.025, is heard well from 0900 with programs in *English*; has dance music 1000-1030 closedown. (Ridgeway, South Africa)

Manchuria—Mukden, 7.660, has been noted 0500-0855. (WRH)

Martinique — Nattugglan, Sweden, says FNRI, Radio Martinique, Fort-de-France, has been heard on 9.680 at 1935-2000; *not confirmed*; may have been confused with Paris on 9.685 which runs to 2000 closedown.

Monaco—Radio Monte Carlo, 6.035. 9.785, has *English* program, "Hour of Decision," Thursdays 1730-1800A sign-off, and "Back to the Bible" 1730-1800A sign-off Fridays. (Bellington, N.Y., others)

Mozambique—The *English* commercial service of Lourenco Marques is now using 11.742 instead of 11.765 as formerly. The Portuguese service is now using 6.14 at 0400-0630, and also 1030. (Ridgeway, South Africa) Heard signing off 1515 on 15.285A with "A Portuguesa"; fair to good level in N.Y. (Bellington) CR7BE, 9.810A, noted 0030 in Portuguese session. (Patterson, Ga.) Is heard 0000-0100. (Rosenauer, Calif.)

New Zealand—Revised schedules have just been received via airmail from Radio New Zealand—to Australia 1300-1515, ZL2, 9.540; 1530-0145, ZL10, 15.220; 0200-0545, ZL2, 9.540. To Pacific Islands 1300-1515, ZL9, 11.810; 1530.0145, ZL4, 15.280; 0200-0545, ZL3, 11.780.

Nigeria — Nigerian Broadcasting Service, 32 Marina, Lagos, Nigeria, verified reception of "7.083," stating frequency is actually 7.079; this is a 250-watt regional transmitter at Enugu in the Eastern Provinces; another regional station—low powered—is at Kaduna in the Northern Provinces on 4.925 during "hours of darkness" and 7.165 during "daylight hours" (local time). Officials said Lagos operates on 9.650, 7.5 kw., 0100-0215, 0530-0800, 1200-1500; channels of 6.100 and 7.255, low-powered, broadcast 0100-1700 with one break 0345-0530. Relays many BBC programs. Has been heard on 9.655A by Bellington, N.Y., and Kary, Pa., however, as late as 1700 closedown.

North Korea—Radio Pyongyang, the Korean Central Broadcasting Service, now broadcasts in Japanese on 4.400, 6.250 at 0800-0900. (Japanese Short-Wave Club)

Pakistan—Radio Pakistan is now on regular transmission (after completing

for dependable sound,
INDUSTRY relies on
ATLAS



DR Double-Reentrant Projectors

DEPENDABLE QUALITY:

The latest electro-acoustic research and engineering—and over 20 years of manufacturing know-how—are behind every ATLAS product.

DEPENDABLE SERVICE:

Coast-to-coast and around the world today—in every Industrial, Marine, Railroad, Military, Educational, Civic, U.S. and Foreign Government application—under every kind of climate and noise condition — ATLAS sound equipment is famous for highest efficiency and durability. That's the proof of ATLAS performance dependability.

DEPENDABLE DELIVERY:

Yes, ATLAS gives our Government highest priority. And yes, we too feel the pinch of material shortages. But our customers will continue to get our usual dependable delivery—because we believe in equitable and dependable distribution to all ATLAS users.

DEPENDABLE PROFITS:

Completeness of line, excellence of product, dependable delivery, right prices—that's the ATLAS combination that means high, steady Industrial Sound profits for You!

JUDGE for yourself, COMPARE ATLAS of your local Jobber today. See why ATLAS is the preferred line for utmost dependability. Write NOW for FREE latest Catalog 55 I



Paging & Talk-Back Speakers



ALNICO-V-PLUS Driver Units



Dual Speakers



FULL-GRIP, VELVET-ACTION Mike Stands



ATLAS SOUND CORP.

1446-39th Street, Brooklyn 18, N. Y.
In Canada: Atlas Radio Corp., Ltd., Toronto, Ont.

RADIO and TELEVISION ELECTRONICS



in all Technical Phases New Classes (Day and Evening) Start 1st of Dec., Mar., June, Sept.

Free Placement Service for Graduates For Free Catalog write Dept. RN-52

RCA INSTITUTES, INC.

A Service of Radio Corporation of America 350 WEST 4th ST. NEW YORK 14, N. Y.

FREE

Write today for "How to Service T. V. Receivers" with the HICKOK VIDEO GENERATOR.

The Hickok Electrical Instrument Co.
10824 Dupont Ave., Cleveland, Ohio

RADIO & TELEVISION NEWS

tests) to Turkey at 1430-1515 and to the United Kingdom 1515-1600 close-down on 7.010, 9.484. (Pearce, England, others) Heard with news 0330-0340 near 17.715. Noted with strong signal in program for Indonesia 0630-0715 on 17.835; announced 15.270 in parallel. (Pearce, England) Heard on 15.335 at 1915 with program for home listeners. (Sanderson, Australia) Is noted daily on 6.285A around 0700-1000, all-native; identifies often. (Wada, Japan) Now uses 9.762 instead of 11.844 for news 1015; heard on 6.23 with native programs 1115-1200. (Ridgeway, South Africa)

Panama—HO50, 5.996, noted in Australia 0145 with Spanish program of music and news. (Sanderson) HOJA, 9.645, noted 2140 with commercials in Spanish. (Pelegri, N.Y.)

Paraguay—Radio Encarnacion, ZPA5, 11.945, noted at good level from 1500 onwards. ZPA1, 6.278, Asuncion, is high level 2100 to close at 2200; features dance music 2100-2200. (Ridgeway, South Africa)

Peru—Radio Central, Lima, has moved from 9.522 (listed 9.545) to 9.550; weak level; uses call of OAX4K and Andalusian Spanish. (Stark, Tex.)

Philippines—Radio Free Asia, 6.11 Manila, noted closing 0920 when announced channels of 11.94 and 6.11 for Manila, 9.49 for Guam. (Balbi, Calif.) DZH4, 6.000, Manila, noted in English 0900, CWQRM. (Flynn, Calif.)

The Far East Broadcasting Co., Manila, has brought into use a 16-m. channel of measured 17.805; is reported opening 0300; has been heard by Sanderson, Australia, also around 2300 when signal strength was especially good in Melbourne, also with news 0500; call is DZ16. The 16-m. outlet is heard by Ridgeway, South Africa, at good strength in parallel with 9.73, 11.855, 15.300, and from 0900 to 6.030; heard from around 0800 to closedown 1200, English from 1000. DZ16 has been heard in Sweden by Engberg 0500-0600.

Poland—Warsaw lists English (presumably for Europe) as 0130-0200, 6.140, 7.155, 5.995; 1200-1230, 7.175, 9.555; 1230-1300, 6.115, 9.555, 7.145; 1400-1430, 6.115, 9.555, 7.145; 1430-1455, 6.140, 7.155, 5.975; 1730-1800, 6.140, 7.155, 5.975. (Pearce, England)

Portugal—Lisbon, 6.360, noted 1754-1800 when signed off with "A Portuguesa." (Machajewski, N.Y.)

Portuguese Guinea—CQM sent QSL card and mentioned only 5.838 at 1630-1800. (Pearce, England)

Portuguese India—Radio Goa, 9.61, heard in Hindi 0930, in Portuguese 1000; in English 1030 (Mondays has "Old Fashioned Revival Hour" transcription); has guitar interval signal; is in foreign language 1130 and closes 1230, good level in South Africa. (Ridgeway)

Reunion—Radio St. Denis, 7.168, has strong signal in South Africa opening 0915 with announcements in French; 0930 light music, French songs; calls "Ici Reunion, Radiodiffusion Francaise" by man; woman also an-

BLOWERS—115 VAC 60 CYCLE



SINGLE TYPE: (Illustrated at left) 100 CFM. 2 1/2" intake; 2" outlet. Complete size: 5" x 6". Order No. RN-520. **\$8.95**

DUAL TYPE: 100 CFM. 3" intake; 2" Dis. Each Side. Complete size: 8" x 6". Order No. RN-800. **\$13.95**

COMPACT TYPE: 108 CFM. Motor on top inside squirrel cage. 4 1/2" intake; 2 3/4" x 3" Dis. Complete size: 4 1/2" W x 8 1/2" H x 8 1/2" D. Order No. RN-860. **\$14.50**

FLANGE TYPE: 140 CFM. 3 1/2" intake; 2 1/2" Dis. Complete size: 7 1/2" W x 7 1/2" H x 6 3/4" D. Order No. RN-965. **\$13.95**

FLANGE TWIN: 275 CFM. 4 1/2" intake; 3 3/4" x 3" Dis. Complete size: 11 3/4" W x 8 3/4" H x 8 1/2" D. Order No. RN-134. **\$21.95**

DYNAMOTORS

DYNAMOTOR and BLOWER: 9 Volts DC Input; output 450 Volts 60 MA. 4500 RPM. At 6 Volts DC Input; output 260 Volts 65 MA. 3000 RPM. Price. **\$4.95**

PE-101C DYNAMOTOR. . . . NEW \$4.95

INPUT:	OUTPUT:	STOCK No.:	PRICE:
14 V. DC	600 V. 300 MA.	BD-86	\$9.95
12 V. DC	220 V. 70 MA.	DM-24	6.95
12 V. DC	220 V. 100 MA.	DM-18	4.95
14 V. DC	375 V. 150 MA.	DM-375	8.95
14 V. DC	330 V. 135 MA.	DM-330	7.95
14 V. DC	500 V. 500 MA.	PE-50	14.95
12 or 24 V. DC	275 V. 110 MA.	USA/0516	3.95
12 V. DC	250 V. 50 MA.	DM-25	8.95
12 or 24 V. DC	500 V. 50 MA.	USA/0515	3.95
12 or 24 V. DC	440 V. 200 MA.		
28 V. DC	225 V. 100 MA.	D-104	14.95
	250 V. 60 MA.	PE-80	5.95

COMMAND TRANSMITTERS

Complete with Tubes & Crystals

BC-457 Transmitter—4 to 5.3 MC.—Used	\$ 8.95
BC-458 Transmitter—5.3 to 7 MC.—Used	7.95
BC-459 Transmitter—7 to 9 MC.—NEW	22.95
BC-456 Modulator. NEW	\$5.95—Used. 2.95
Transmitter Back—Single	\$1.50—Dual. 2.00
Rec. Back—Dual	\$1.50
Modulator—Mig.	1.50
Rec. Dyn.—Used	\$2.95
Trans. Dyn. Used	2.95

AIRCRAFT CONTROL CABLE

3/32"—7x7 Strand. Weatherproofed, Galvanized, Preformed. 920 lb. test. Ideal for Television Guying and many other uses. Prices:

4 1/2¢ per Ft.—1000 Ft. or more @ 4¢ per Ft.

POWER SUPPLIES

PE-157 POWER SUPPLY—2 Volt Vibrator Supply. Operates from BR-54 2 Volt Battery mounted in Case. Output voltage 1.4 V. 1/4 Amp 125 V. 50 MA. Less Battery. Speaker & External Power Cord—with Vibrator. \$4.95
BR-54 2 Volt Dry Batteries. 2.95
MR-28 BA Power Supply & Modulator \$29.95
MTA-12—New
Power Supply No. 3 (Mark II No. 19 Radio Set. 12 or 24 V. Two PM Dynamotors: 500 V. 50 MA.; 275 V. 110 MA.—New) \$12.95
PE-104 Vibrator Unit (BC-651) 10.95
550C Vibrator (PE-104)—New 1.95
VB-16 Vibrator (PE-237—SCT-694)—New 4.95
VB-9 Vibrator—6 Volt 4 Prong—New 1.00
VB-8 Vibrator—2 Volt—New 1.00

Address Dept. RN • Minimum Order \$5.00 • Prices F.O.B., Lima, O. • 25% Deposit on C.O.D. Orders

FAIR RADIO SALES

132 SOUTH MAIN ST. LIMA, OHIO

TRANSFORMERS AND CHOKES

TRANSFORMERS—110 V. 60 CYCLE PRIMARIES:

5 Volt CT-25A—10,000 V. Ins. OPEN FRAME—6" x 5" x 4 1/2"	\$7.95
6.3 V. 1 Amp. . . . 1.25	24 V. 1 Amp. . . . 1.95
24 V. 1/2 Amp. . . . 1.50	24 V. 6.5 Amp. . . . 5.95
6—24—or 30 Volt 8 Amp. . . .	5.95
Two 12 V. 4 A. windings, gives 12 V. 8 A. or 24 V. 4 A.	5.95
325-0-325 V. 50 MA.—6.3 V. 2.5 A.; 6.3 V. .6 A (Rect. 6x5) Half Shell—2 1/2" x 3 3/4" x 3"—No. T-23-28	2.75
440 VCT/70 MA—5 V. 2 A.—6.3 V. 4 A.	3.35
490 VCT/60 MA—5 V. 2 A.; 6.3 V. 4 A.; 6.3 V. 2 A.	3.25
460 VCT/90 MA—5 V. 3 A.; 6.3 V. 4 A.	3.75
175-0-175 V. 40 MA.—6.3 V. @ 2.4 A.; 6.3 V. @ .6 A. Half-shell 2 1/2" x 2 3/4" x 2 3/4"—No. T-23-40	1.75
350-0-350 V. 90 MA.—6.3 V. @ 3 A.; 5 V. @ 3 A.; 1-prong—3 1/2" x 3 3/4" x 3 3/4"	3.25

CHOKES

5 Henries—150 MA. 85 ohms DC—Res. Cased.	\$1.95
8 Henries—150 MA. 200 ohms.	1.95
5-20 Henries—300 MA. 110 ohms. 1000 V. Ins.	3.95

AERIAL WIRE—Phosphorus Bronze #16 Stranded. 200 lb. test. Weatherproof. 150 Ft. on Reel. RL-3 w/Clips **\$1.50**
Telephone Wire—3 Cond. copper & steel. 525 Ft. 4.75

ANTENNA EQUIPMENT

MAST BASES—INSULATED:

MP-132 BASE—Illustrated at left—1" heavy coil spring. 2" insulator. Overall length: 11 1/2". Weight: 2 1/2 lbs. Price **\$3.95**

MAST BASE—Insulated type with heavy coil spring and 5" dia. insulator. Requires 1" hole for mounting. Weight: 9 lbs. **\$5.95**

MAST SECTIONS FOR ABOVE BASES

Tubular steel copper coated painted, in 3 ft. sections, screw-in type. MS-55 can be used to make any length with MS-55-51-50 49 for taper. Any section **50¢** each
Larger Diameter Sections: MS-55-54. **\$1.25** Each

TRANS.—REC.—AMPLIFIERS

TA-121: TRANSMITTER with Tubes—Used.	\$39.95
RI/ARI-1 Receiver—easily converted to 220 MC. (See R.N. Jan. '49) Complete w/Tubes. NEW	\$4.95
RA-10 DB Receiver—24 Volt with Tubes and Dynamotor—Used	\$29.95
BC-1206—200-400 KC. Delco. w/Tubes	\$9.95
BC-216 Amplifier—2 Tubes—617, 30/41	1.95
BC-367 Amplifier—w/Tubes, less Dyn.	\$4.95
BC-605—With Tubes, Used.	3.95
BC-709—W/Tubes—New	\$4.95
Used:	3.95
BC-347—Less Tubes—New	\$2.95
Used:	1.95

CORDS—CABLES

CD-501 Cord 7/GN-45 Generator	\$2.50
CD-318 Cord w/PL-68 & SW-141 & JK-48F	.89
CD-307 Cord—6.5 Ft. w/PL-55 & JK-26	.89
CD-604 Cord w/C-410 Trans. & PL-51 Plug	.89
CD-365 Cord for LP-21 Loop	1.50
MC-215 Tuning Staff for 274N	2.00

SPEAKER RECONING

Complete line Cones, Spiders, Rings and Voice Coils. Custom Built Voice Coils. Low prices. Write for Parts List and Reconing Information.

WESTERN ELECTRONICS CO.

3164 West Colfax Denver 4, Colo.

From the earliest days of Radio . . . to the present era of Television . . .

"Made by Engineers for Engineers"

CORNISH WIRE CO., Inc. — 50 Church St., N. Y. C. 7

WANTED

SCR-510, 610, 508, 608, 522, 300, etc.

BC-603, 683, 923, 620, 659, 604, 684, etc.

Receivers: BC-312, 342, 348, etc. APR-4, APR-5; RAO, RCH, RBO, etc.

ART-13, ARC-3

Any test equipment with TS- or I-prefix— and any RADAR

WE PAY HIGHEST PRICES

Make your offer and be convinced!

Please describe condition accurately and advise price desired

AMBER COMPANY

393 Greenwich Street New York 13, N. Y. BEekman 3-6510

HARVEY

where you FIND the FINEST

THE ORIGINAL WILLIAMSON HR-15 AMPLIFIER KIT

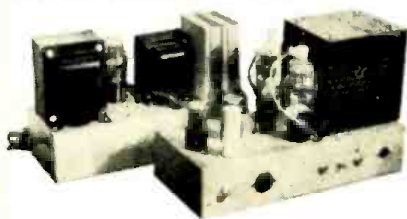

The famous, original Williamson HR-15... still acclaimed the leader... in kit form, with the Partridge Output Transformer specified by Williamson in his original design. Assemble this kit, and in 3 hours or less, enjoy the finest sound you ever heard. Operates from a tuner, phono-preamp, crystal pick-up, or other signal source. Absolute gain is 70.8 db with 20db of feedback. Frequency response: $\pm .5$ db, from 10 to 100,000 cps. Output impedances to match all speakers from 1.7 to 109 ohms. Kit is complete with 5 tubes (1-5V4, 2-6SN7, and 2-5881 (or 807 if requested), 2-Punched Chassis, 2-Resistor Mounting Strips, Sockets, Partridge WWFB Output Transformer, Assembly Instructions, and All Other Necessary Parts for Amplifier and Power Supply. **\$76.50**

PARTRIDGE OUTPUT TRANSFORMERS

Available Separately. WWFB **\$26.00**

NOTE: HR-15 may be had with British KT-66 Output tubes for \$3.00 additional.



ELDICO TR-75-TV TRANSMITTER KIT

An ideal unit for the novice. New, revised circuit minimizes TVI. Uses 6L6 oscillator - 807 amplifier. Combination PI-network output. Husky power supply delivers 600 volts to the 807. Complete... including punched chassis and shielded cabinet. Unbelievably low priced at **\$64.95**

MD-40 modulator kit for above... **49.95**
MD-40P as above but with power supply... **59.95**

Write for literature on the Complete Eldico Line.

New Deluxe Transmitter Kit JOHNSON VIKING II



100 WATTS ON PHONE
130 WATTS ON CW

Every desirable feature has been included in this outstanding transmitter: BAND-SWITCHING to all amateur bands, from 160 through 10 meters... TVI suppression... 100% AM modulation... PARALLEL OUTPUT 6146 tubes... PUSH-PULL 807 MODULATORS. Supplied complete with pre-punched chassis, copper-plated steel cabinet, tubes, hardware, assembly instructions, and all necessary parts and components. **\$279.50**

Viking II complete with tubes, wired and air tested **324.50**
Viking VFO Kit **42.75**
VFO Kit—wired and tested (with tubes)... **62.75**
Viking Mobile Kit, up to 60 Watts input **99.50**
Viking Low Pass Filter, 4 section, 75 DB Att., handles a KW **16.50**
Viking TVI Kit, everything to TVI suppress the Viking I **24.75**

NOTE: Prices Net, F.O.B., N.Y.C. Subject to change without notice.



Harvey

RADIO COMPANY, INC.

103 W. 43rd St., N.Y. 36, N.Y. • LU 2-1500

nounces; 1100 gives news in French; 1115 dance music; a Soviet transmitter swamps the station around 1125. (Ridgeway)

Sao Tome—CR5SB, 17.677.5, noted Sundays 0750 when tuned with dance music; at 0757 had call, guitar music, details of next program and closing announcements in Portuguese; left air 0800A after "A Portuguesa." (Pearce, England; Ferguson, N.C.) CR5SC, 4.809, is good level opening 1430, light musical programs to closedown 1600; gives call frequently (by man). (Ridgeway, South Africa)

Saudi-Arabia—Djeddah is noted opening around 2215 on 6.177A and 7.245A with usual interval signal; uses Arabic; closes around 2304A. (Bellington, N.Y. others)

Somalia—Mogadishu, 7.383, is heard from 0915 in Arabic to 1200, when goes into Italian until 1300 closedown. (Ridgeway, South Africa)

South Korea—HLKA, 7.935A, Pusan noted 0630 with Western music and Korean news. (Sanderson, Australia) Wada, Japan, says is now operating on 7.935 and 9.555 at 1600-1800, 2130-0030, 0330-0900, all in Korean. Flynn, Calif., reports HLKA on 4.4785 at 0845, S6, in oriental language, much QRM.

Spain—Radio Mediterraneo, Valencia, is noted now near 6.995 from audibility around 1425. Radio Juventud le Murcia has been moving around, noted more recently on 7.105A with dance music 1655; gave call in Spanish 1700, and was soon buried by sign-on of a Radio Free Europe station. A Spanish Nationalist outlet has been heard on 7.420, but it is not Radio Menorca; signs on 1500 with singing of march and signs off with similar number 1705; call sounds like "Transmite Radio Cartagena." (Pearce, England) FET1, 7.006, noted 1630 with Spanish program of news, music. (Sanderson, Australia) Malaga, 7.012A, is still noted with Spanish Home Programs around 1515 onwards, fairly good level. (Ridgeway, South Africa)

Sweden—Radio Sweden, 11.705, noted with news 2300, then music. (Sanderson, Australia) Heard on 15-155 with news around 1000, fair level. (Scheiner, N.J.) Noted on 9.535 at excellent strength 1900-2000. (Deem, W. Va.)

Switzerland—Damascus, 17.865, heard 0945-1045 to India-Pakistan. (Pearce, England) On 11.913A with news 1720-1730 closedown. (Black, Pa.)

Tahiti—Radio Tahiti, 6.135, Papeete, is heard around 0000; signs off 0130. (Kary, Pa.)

Taiwan—BEC26, 10.060A, noted from 0910 tune-in with Chinese session to 1000 closedown. (Pearce, England) Taipei, 15.235, heard with news 2200 to North America. (Annala, Oregon) BEC32, 9.775A, Taipei, noted 0700 with English commentary and Western music; asked for reports. (Sanderson, Australia) A Taiwan outlet is noted on 7.045A around 0500-1030 closedown; call seems BEC22, BEC32, or BEC34; is not parallel with 9.855

which is heard quite irregularly; another Taiwan station is noted on 7.340A to 1030 or 1100. (Wada, Japan)

Tangiers—Radio Africa is on a new channel of 7.192 as early as 1015, and as late as 1745. (Pearce, England; Kary, Pa.) Radio International, 6.110A, noted with news in Spanish 1700. (Pearce, England) Pan-American Radio, 7.300, is heard with clock chimes (12) at 1900 and multi-lingual announcements to 1904 sign-off. (Kary, Pa.)

Thailand—Bangkok, 11.910, has English session 0500-0630, fair level; announces also 15.630, 7.140 (is nearer 7.105—K.R.B.), 6.240. (N. Z. DX Times)

Uruguay—Radio Electrica, CXA10, has extremely good signal from around 1130 with classical music; call is given every half hour by man; has QRM from Radio Dakar at 1400. Radio Ariel, CXA3, 6.075, is noted at good strength from around 2030 to closing 2200, man gives call in Spanish. (Ridgeway, South Africa) Niblack, Ind., notes CXA10, 11.900, at good level 1800 and closing 2210.

USI (Indonesia)—A station believed Djakarta is heard with strong signal mornings to 1030 closedown on 9.865; at times location sounds like "Jogjakarta," however. (Stark, Texas; Kary, Pa. others) Noted on 9.585 from around 0800-1030 closedown. (Balbi, Rosenauer, Calif.)

USSR—Radio Tashkent, 6.825, is noted with English for India-Pakistan 1000-1030, 1115-1130 (some days English begins 1030, however). (Pearce, England) Moscow is noted on 11.68A with English (review of Moscow press) and music 0500-0530 fade-out. (Jones, France) Frequencies used by Moscow for the 1820-0100 period to North America are 15.330, 15.250, 15.230, 15-110, 11.910, 11.830, 11.810, 11.710, 9.670, 9.650, 9.550, and 7.240 (some of these are actually relays by satellite countries); the 0800-0830 transmission to North America is over 17.830, 15.440, 15.360, 15.180, 15.120, 11.910. (Kary, Pa.)

Vatican—HVJ, 5.968, noted 1545 with chimes and then news in Italian. (Sanderson, Australia) Noted on 11.74 with news 1000, fair level; also heard on this channel with English 1315. (Scheiner, N.J.) Noted with English period 1315 also on 9.550. (Kary, Pa.) According to NNRC, HVJ has news Wednesdays, only 0930-0940 on 17.775 for Near East.

Venezuela—Radio Rumbos has English session Mon.-Fri. 1800-1900 over 4.970, presented by Jay Farr; first 45 minutes is disc jockey session called "Supper Club" and last 15 minutes (1845-1900) consists of a roundup of latest world and local news. (West, Va.) YVKB, 4.8903, noted S5 at 0612; YVMM, 4.9096, was S5 at 0615; YVKM, 5.0294, noted S5 at 0619, CWQRM. (Oskay, N.J.)

Yugoslavia—Belgrade, 6.100, noted signing on 2330; has English 0130 and then is heard parallel on 9.505. (Bellington, N. Y.) English is now sched-

duled 0130 on 6.100, 9.505; 1100-1115, 6.100, 7.200; 1315-1330, 6.100, 6.150; 1645-1700, 6.100, 6.150 (WRH)

* * *

Press Time Flashes

When this was compiled, a station on 4.950, identifying (in *English*) as "the Broadcasting Service of Radio Belize" was being heard around 1830-1904 closedown. (West, Va.) Good level in West Virginia but with CWQRM and aircraft phone QRM. Is British Honduras.

The *Radio Clube de Angola*, Luanda, Angola, is now using a *new* channel of 4.873 in parallel with 9.632, 11.865; heard from around 1330. (Ridgeway, South Africa)

The Central Broadcasting Station, Lusaka, 4.826. North Rhodesia, is noted around 1210 with dance records; with talk in *English* 1230. BBC news relay 1300; probably signs off 1400. (Pearce, England) Ridgeway, South Africa, lists ZQP at 0700-0900 on 7.220; 0900-1100 on 7.220 and 4.826; 1100-1230 on 7.220, 4.826, and 3.275; 1230-1400 closedown on 4.826, 3.275.

The Japanese Communist station *Radio Free Japan* broadcasts on 10.180, 11.896 at 1500-1600, 2200-2300, 0500-0600, 0730-0830; uses Japanese *only*; is probably located in Communist China. (Japanese Short-Wave Club)

Legge, New York, notes *Radio Free Europe* afternoons (EST) on 11.855, 11.725, 9.717, 9.695, 9.607; fair signals around 0600 on 11.745, 11.675. (NNRC)

An Arabic-speaker reported some months ago by Cushen, N.Z., heard on 5.000, has been identified by Bert Bluman, Israel, as located at Kuwait in the Persian Gulf; operates 1130-1400 and identifies *only* at sign-on; programs are all-Arabic. (Radio Australia) (Al Kuwait is a sultanate in Arabia, south of Iraq, on the north-western coast of the Persian Gulf; it is a British protectorate with a population estimated at 50,000.—K.R.B.)

Latest schedules for the *COURIER*, the *Voice of America's* "Truthship," are 1200-1615 to Near East and 1730-1900 to Caucasian USSR on 6.015; 1730-1900 on 7.200 to Caucasian USSR. VOA is now sending out QSL cards for reports on reception when the *COURIER* was testing from the Panama Canal Zone some months ago.

By this time, the 1953 edition of *WORLD RADIO HANDBOOK*, compiled in Copenhagen, Denmark, by O. Lund Johansen, should be available from Ben E. Wilbur, 1000 Connecticut Ave., N.W., Washington, D.C. It is written in *English*.

"Australian DX-ers Calling" is now aired each Saturday 2300 on 15.200; each Sunday 0030 on 15.200, at 0300 on 9.580, 11.760, 17.840, and at 0902 on 9.580, 11.840, 15.320.

The Korean Broadcasting System operates a network of 15 stations, two of which are short-wave—HLKA on 2.510, 7.935, each 1 kw., and located in Pusan. A *new* short-wave station will open shortly in Seoul, using 10 kw. QRA is Hahn Ki Syan, Chief Engineer,

More Profits from the Complete line of SUPERIOR ROHN TOWERS

Standard Self-Supporting ROHN steel TOWER

Proved to be the BEST answer to your Tower needs!

Thousands of installations prove ROHN superior in design, construction, and quality. Made in standard 10 ft. sections, using heavy duty tubular steel and electric welded throughout. Tests prove the rugged construction . . . can be climbed . . . no guying needed up to 50 ft. Double-coated with a finish that's permanent and non-corrosive. Quickly installed in cement base. These towers can be used to any height . . . even up to 150 ft. Here's true permanent installation that has real sales appeal. Get the facts — you'll be convinced ROHN is BEST!

— 2 other Rohn Models for you!



	<p>ROHN "FOLD-OVER" TOWER</p> <p>This type tower is built by merely using regular Rohn tower sections and an inexpensive Fold-Over kit. Has all the advantages of the standard Rohn tower, but is of the fold-over type that makes it perfect for antenna changing, rotator servicing, experimentation, etc. Kit includes hinged section, boom, reel and cable mechanism, 4 guy anchors and special base section.</p>	<p>ROHN TELESCOPING MAST</p> <p>is quickly installed and raised to desired height in a moment. Heavy-duty galvanized steel tubing in heights from 20 to 50 ft. An absolutely sturdy and durable mast . . . non-corrosive and indestructible. Excellent rigidity at joints. Comes complete with guy rings, and all necessary parts for instant installation. . . can be purchased with or without base. Available in 20, 30, 40, and 50 ft. sizes.</p>
--	--	--

FULL LINE OF ACCESSORIES:

New Quick "Drive-In" Base for use with standard towers in place of concrete base. Permits instant tower erection. Not recommended under certain conditions, however.

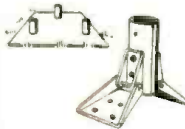

Bases for Rohn Telescoping Masts.

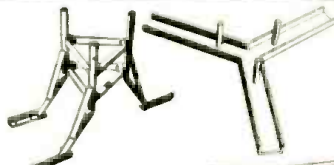

Peak roof mounts for use with standard tower

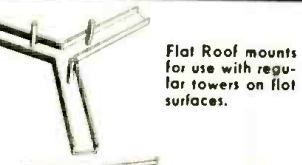

Flat Roof mounts for use with regular towers on flat surfaces.



House Brackets for added stability.

"Sell the ROHN line . . . where Satisfaction and Quality are Assured."

WRITE PHONE OR WIRE FOR FREE CATALOG AND PRICES!
Designed and Mfg. only by:

ROHN MFG. CO.

Dept. RTN, 2108 Main St., Peoria, Illinois

All Rohn Products Sold only Through Authorized Representatives & Jobbers.

When Answering Advertisements
Please Mention
RADIO & TELEVISION NEWS

New Proximity Probe

Tests All TV Hi Voltage Supply Systems

INSTANTLY checks hi-voltage transformer action—horizontal oscillator—sweep output—damper—hi-voltage rectifier, etc. Used under actual operating conditions. Determines exact procedure to trouble shoot no raster problems and intermittents. No connections—no shocks—saves time—clips in pocket. Used by professional TV servicemen for home calls and bench work. Complete instructions enclosed.

Send check or M.O. \$3.95 Fully Guaranteed
Postpaid U.S.A. Net

Box 215 SERVICE PRODUCTS CO. Lawrence, Mass.

EASY TO LEARN CODE

It is easy to learn or increase speed with an Instructograph Code Teacher. Affords the quickest and most practical method yet developed. For beginners or advanced students. Available tapes from beginner's alphabet to typical messages on all subjects. Speed range 5 to 40 WPM. Always ready—no QRM.

ENDORSED BY THOUSANDS!

The Instructograph Code Teacher literally takes the place of an operator-instructor and enables anyone to learn and master code without further assistance. Thousands of successful operators have "acquired the code" with the Instructograph System. Write today for convenient rental and purchase plans.



INSTRUCTOGRAPH COMPANY

4711 SHERIDAN ROAD, CHICAGO 40, ILLINOIS

STAN-BURN SPARKS

ANTENNAE SPECIALS

DOUBLE V 3/8"	1.11	12 or more	\$2.20
DOUBLE V 1/2" Dowel	3.45		2.45
DOUBLE V 3/4" Dowel	3.95		2.95
10 Element Conical 3/8"	3.55		2.55
Folded Hi Straight Low Quick Rig	4.25		3.25
12 elements	4.95		3.75
WINDOW CONICALS			
5 FOOT SWEGDED MASTS	.79		.69
10 FOOT PLAIN TV WIRE	1.39		1.29
85 MIL. 300 OHM		\$14.95 M Ft.	
72 OHM COAXIAL		45.00 M Ft.	

CATHODE RAY TUBE SPECIALS

Standard Brands—Unconditionally Guaranteed

GENERAL ELECTRIC	21EP4A	33.98
SHP4	24AP4A	66.95
7IP4	SHELDON	
10BP4A	10BP4A	13.00
10FP4A	12LP4A	16.20
12KP4A	14BP4A	18.50
12LP4A	15DP4	20.50
12UP4B	16FP4	22.60
14CP4	16EP4A	22.60
14EP4	16DP/MP4A	22.60
16AP4A	16JP4A	22.60
16DP4A	18BP4	25.90
16GP4	16KP4A	22.60
16KP4 16RP4	17BP4	23.70
17BP4A	18BP4	25.90
17CP4	19AP4	25.90
19AP4A	20CP4	28.00
20CP4 2DHP4A	21EP4	29.50
20LP4	16EP4A Rauland	38.20

CLASSIS 630 REGAL with Cascade Tuner. \$139.50
 #11 73 FLY BACK (Similar to RCA). 2.98
 OPEN FACE CABINET 39.00

TRANSFORMERS

RCA type for 16" to 24"	\$3.85
G.E. type for 16" to 24"	3.85

These are very special prices while they last!

DEFLECTION YOKES

COSINE FERRITE TODD YOKE 70"	\$4.20
------------------------------	--------

SPECIALS

4 Prong Vibrators, each	\$ 1.29
Lots of 12 or more	1.19
Standard TV Tuners	18.95
12" Heavy Slug Speaker	Special 4.98

Audio Devices, Discs and Scotch Tape in Stock

Audio Plastic Reel Oxide Plastic tape—	
Half-hour spool	\$2.30
One-hour spool	\$3.30

WIRE RECORDERS IN STOCK

WILCOX GAY—Model 2A10	\$ 89.97
PENTRON—Model ST3C—2-speed Tape Recorder	134.50
RADIO CRAFTSMAN	
Model RC2—HiFi Amplifier	Net 42.89
Model RC10—AM-FM Tuner	Net 130.84
Model CS—Williamson Amplifier	Net 99.45

Cascade Guaranteed Tuners (with tubes)

SPECIAL! While they last	\$21.95
--------------------------	---------

AUTHORIZED DISTRIBUTORS for: General Electric, Kenrad, Tung-Sol, National Union, Jewell, De Wald, Regal, Automatic and Satchel Carlson.

We carry a complete line of popular makes of Radio and TV tubes, at 50% discount. Also many other special purpose and transmitting types, and all electronic parts and equipment at lowest prices. Send us a list of your requirements for prompt quotations. Terms: 20% with order. Balance COD. All prices F.O.B. NEW YORK Warehouse. Minimum order \$5.00. Write for our latest price list to Dept. RN-1

STAN-BURN RADIO and ELECTRONICS CO.
 (C.B.S. THEATRE BLDG.)
 1697 BROADWAY • NEW YORK 19, N.Y.

Korean Broadcasting System, Office of Public Information, Pusan, Republic of Korea. Schedule is 1600-1830, 2100-2400, 0300-1030. (Cushen, N.Z.)

A station noted on 9.310A around 1710-1847 sign-off in Danish and Greenlandic is believed to be Godthaab, Greenland. Has bad QRM at times. (Bellington, N.Y.; Kary, Pa.)

A new outlet in Sao Paulo, Brazil, is noted on 11.855 around 1830. (Niblack, Ind., others)

ISWC, London, says "The Voice of Zion," Israel, has an experimental transmission to South Africa on Sundays 0630-0730 over 15.550 (frequency may be varied).

YVMG, *Radio Popular*, 4.810, Maracaibo, sent QSL card; listed YVMG, 4.810, 2 kw.; YVMH, 1250 kc., 2 kw. QRA is Apartado Postal No. 347, Maracaibo, Estado Zulia, Venezuela. Says is affiliated with *BBC, NBC, United Nations Network of Peace*, as well as *Radio Programas de Mexico*. (Patterson, Ga.)

Schedules of *Radio Tirana*, Albania, on 6.560, 500 watts, and 7.850A, 3 kw., are 2300-0100, 1100-1130, 1215-1700; *English* is listed for 2345, 1600. (Radio Sweden)

Bellington, N. Y., notes the clandestine *Yugoslav Emigrant Station* on 6.887A parallel with an outlet on 7.500A around 1750; has man and woman alternating in European language.

British Honduras is to have a better short-wave service soon; a 5 kw. short-wave station is expected to be in operation at Belize by next March. (Catch, England)

Radio France-Asie, Saigon, Indo-China (Vietnam), has been noted back on its old 11.83 channel from 11.924A, signing off 1125. (Balbi, Calif.)

Sanderson, Australia, notes a much improved signal from the Chinese Air Force Station, Taipeh, Taiwan, on 9.750A at 0700 when has *English* ses-

sion. May have installed a new and more powerful transmitter?

Radio Free Europe noted on 10.300A when tuned 1000; melody followed by call, then program in Hungarian; news in Czech 1015. (Pearce, England)

The Free Greek Radio appears to be on about 6.970; intercepted at 2255 when had Greek language session running past the hour. Signal was gone when retuned 2315. (Kary, Pa.)

A clandestine station announcing as "Freidomsender" is heard in Sweden on 7.700 at 0230-0245.

EDV10, *Estacion Escuela Radio S.E.U.*, Madrid, sent usual QSL card; said is on 7.170 but enclosed schedule for Esperanto transmission (at 1430) which gave channel as 42.33 m. or 7.088. (Pearce, England)

When this was compiled, the BBC's programs for the Western Hemisphere were listed—*North American Service*—To Canada, USA, Mexico, 1000-1215, 17.715; 1300-1545, 11.930 (Mon.-Fri.); 1500-1545, 9.825 (Mon.-Fri.); 1545-1700, 9.825, 6.195. *Special Programs*—For Falkland Islands, Sun. only, 1130-1200, 17.810; for West Indies, 1815-1845, 9.580, 6.035. *General Overseas Service*—To West Indies, Central America, South America (north of Amazon), 1500-1700, 11.750; 1700-1815, 9.580, 6.035; 1845-2200, 6.035. To South America (south of Amazon), 1500-1700, 11.820; 1700-2200, 9.410, 6.110. To Canada, USA, Mexico, 1700-1845, 9.825; 1700-2200, 6.195; 2300-0115, 6.110.

Acknowledgment

Many thanks for the splendid cooperation during 1952. May 1953 bring you the best in SWL'g. Sorry that space limitations would not permit the use of more of your fine reports this month. Please continue to send your *best tips* to Kenneth R. Boord. 948 Stewartstown Road, Morgantown, West Virginia, USA. Thanks!—K.R.B.

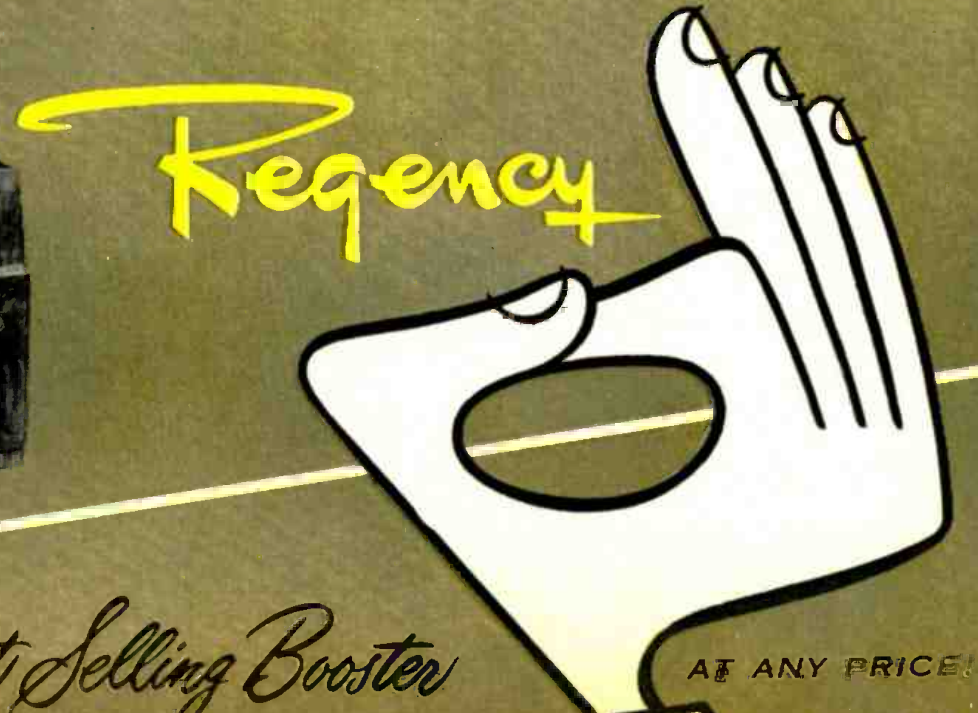

AT ANY PRICE!

Two-Meter Master (Continued from page 41)

The filter network, $R_1-C_{11}-C_{12}$, helps to isolate stray r.f. from the modulation transformer. The r.f. chokes RFC_2 and RFC_3 are identical, wound on a short $\frac{1}{4}$ " diameter polystyrene or ceramic dowel. 24 turns of #28 enameled wire provide adequate choking at 144 mc.

All tube heaters are wired so that the "B" ground return serves as half of the heaters return; at the final amplifier, the 832A heaters bypasses to ground through C_{15} .

Cross neutralization of the final shows lengths of solid hookup wire connected from the grids, across the back of the tube socket, and out through small holes in the socket mounting bracket. The holes support feedthrough bushings, which rigidly support the neutralizing wires running parallel to the plates outside the glass envelope of the tube. When neutralizing the amplifier, start with wire lengths adjacent to the tube's plates extending about $\frac{3}{4}$ " from the feedthrough bushings. Clip off about a sixteenth inch at a time until the amplifier stabilizes. Do not try to operate the amplifier without neutralization; at these frequencies, its use becomes mandatory unless one was born under a very lucky star!

The r.f. section requires 300 to 325 volts d.c. at a current of 175 ma. Any power supply meeting these requirements may be used, and most junk boxes may provide enough parts to run 20 watts input. Separate power supplies are employed for the r.f. and audio sections of the transmitter.

Physical construction of the r.f. section is made upon a "U" channel measuring 10" long, $3\frac{1}{4}$ " wide and $2\frac{1}{4}$ " deep. Inasmuch as W6WGD has been operated from hotel rooms and similarly restricted spaces for the past twenty years, an absolute minimum of space was utilized in this design, if only from force of habit. The unit may be constructed according to its builder's preference, although a similar parts layout should be followed.

Due to its small size, the transmitter uses miniature one-inch meters to read final grid and plate currents.

With reference to Fig. 4, note the point-to-point wiring; resistors R_1 and R_2 are bolted together through their lengths to form a single unit, supported by heavy wires making connections to various tie points. The power input connector provides support for this and other circuit components, as does the second tripler tube socket. Actual constructional features are left to the ingenuity of the reader.

Modulator Section

To convey maximum intelligence, the carrier must be modulated as fully as the law allows; the speech should have good fidelity and crisp response to be clearly defined at the receiving

NOW...AT LOWEST PRICES!

SCR-274N COMMAND and ARC-5 EQUIPMENT

	AS IS (Less tubes)	EXC. USED (With tubes)	NEW
RECEIVERS			
HC-433-190 to 550 KC.	\$10.95	\$23.95	
HC-431-3 to 8 MC.	4.95	\$11.95	
BC-435-8 to 9 MC.	4.95	11.95	\$16.95
TRANSMITTERS			
HC-437-1 to 5.3 MC.	4.95	9.95	
HC-438-5.3 to 7 MC.	4.95	9.95	
HC-439-7 to 9.1 MC.	7.95		
ADDITIONAL EQUIPMENT			
BC-436 Modulator	2.25	2.75	5.75
BC-430 Control Box (3 Receiver)		1.75	2.55
BC-431 Control Box (Transmitter)		1.69	2.29
BC-432 Relay Unit ANT With Condenser		2.79	3.50
Without Condenser		1.29	2.95
Plugs: PL-147, 148, 151, 152, 153, 154, 156.			
Each		1.25	
Flexible Shafting with Gear to fit receivers			2.45
3 Receiver Rack		2.29	2.99
2 Transmitter Rack		2.39	3.97
Single Transmitter Rack		2.25	2.95
1M-32 Dynamotor for Command Set	2.95	3.25	7.95
DM-33 Dynamotor for Command Set		2.95	3.95
Shock Mts. for 3 Receiver Rack, 2 Trans. Rack, Modulator or Ant. Re- lay Unit		1.95	2.45

MONTHLY SPECIAL SURPRISE PACKAGE

20 pounds of assorted radio parts. A real value at **\$1.95**

TUBES.....10 for \$3.50

12SR7	6SL7	1N5	Your choice
1613(6F6)	6V6	3B7	of these
9006	1N4	6AL5	nationally
6Z7G	162G	6A5	advertised
211	954	5Y3	tubes.
6HG	1625	12H6	

90 DAY GUARANTEE		TUBES	
16P4	\$16.95	304TH	\$5.95
16DP4	16.95	803B	1.69
16CP4	16.95	805	2.69
		9002	.59
		9003	.98
		6AJ5	1.89
		4AP10	.95

RT-34 APS-13 Transceiver used as a tall warning radar on 415 KC. Containing a 30MC IF Strip and various other parts, these units have been stripped of RF sections and all tubes, but are an excellent buy if only for parts and IF Strip. Used \$ 4.95
 BC-624 receiver (SCR 522), less tubes. used \$ 4.95
 100 A 156. used 19.95
 BC-625 transmitter (SCR 522) less tubes. used 14.95
 SCR 522 transceiver, complete in case with top bracket, less tubes. used 29.95
 Transceiver-140-144 mc. 2 meter, used, excellent condition, less dynamotor, with tubes. only 24.95

BROADCAST BAND & AERO



MN-26-C Remote Controlled Navigational Direction Finder and communications receiver. Manual DF in any one of three freq. bands, 150 to 1500 KC. 24 V. Self contained dynamotor supply. Complete installation, including receiver, control box, loop, azimuth control, left-right indicator, plugs, loop transmission line and flex. shafts.
BRAND NEW.....\$69.50

WANTED!

All TS, APR, APS, ARC, ARN, ART, SCR, R89 and BC equipment. Write today! Quote lowest prices in your first letter

MIKES and HEADSETS

M5-33 Low Impedance Headset	exc. \$2.95	new \$4.95
M5-23 Headset	exc. \$2.95	new \$4.95
CD-307 Exc. used	\$2.95	new \$4.95
Throat Mike-T 30	like new	.79
Lip Mike-Navy Type	New	.98
Extension Cord and Switch Assembly for Lip and Throat Mikes	New	.98
CW 4905 High Impedance headset complete with leather headband and rubber cushions		Used 98c
T-17, Microphone	Used	98c
M5-38	exc. \$5.95	new \$3.75
M5-30, miniature headset	used 1.49	new 2.49



DYNAMOTOR PE-101C

The best dynamotor for conversion to 6v. Multiple windings! After conversion you get choice of 100 or 350 v. at 50 MA or 250 v. at 100 MA. Complete dope sheet furnished.
BRAND NEW (See "CQ" Aug. Issue).....\$4.65

DYNAMOTORS

PE 103	used exc.	\$19.95
DM 53A	used	2.95
RD 83	exc.	8.50
DM 34	used exc.	9.95
DM 28	new	5.95
	used exc.	2.95

WOBULATOR

BUILD TV-FM-AM SWEEP GENERATOR

You can build "Versatile Sweep Frequency Generator" with AFN-1 magnetic units.....\$5.95

RT7/APN1 TRANSCIVER UNIT—Used as an attenuator, it may be converted for signaling control circuits, etc. Complete with 14 tubes and dynamotor they are in good used condition at the amazingly low price of.....\$17.95
 Used, less tubes, with wobulator.....9.95

BC 604 FM TRANSMITTER
 20-27MC used, exc.....\$12.95

MISCELLANEOUS EQUIPMENT

FL 8 used, exc.....\$1.95 BC 347 each.....\$1.95
 BC 906 each.....9.95 RL 42 each.....3.95

SELSYN TRANSMITTER

Loop Motor and Autovox Transmitter Assembly for matching to T-R2 Indicator. Used, excellent condition.
ONLY \$5.95. Complete with Indicator.....\$14.95

SCR 625 FAMOUS ARMY MINE-DETECTOR

For Prospectors, Miners, Oil Companies, Plumbers, etc. This unit is being offered now at a considerable reduction in price. Recently advertised at \$70.50 it is now available in the same brand new wrappings in suitcase style carrying case (less batteries) at **\$59.50** WHILE THEY Used, like LAST! new, \$39.50

MN-26-Y 150 to 325 KC. 325 to 605 KC. 3-4 to 7 megacycles, comp. installation	\$69.50
Receiver alone	35.95
MN-26-C alone, new	39.50
MN-26-C or MN-26-Y as is, less tubes	13.95
With tubes. Used good	24.95
MN-20-E Loop, Brand New	6.95
MN-52 Crank drive, New	2.50

RL-42 Reversable Motor with antenna reel and clutch, used.....\$ 2.95
 BC-433 RADIO COMPASS RECEIVER, 200 to 1700 KC. used, excellent condition, with tubes. Used good.....39.95
 used, exc., less tubes.....24.95
 parts, as is, less tubes and cover, exc. for use.....8.95

ARMY SURPLUS PORTABLE TELEPHONE
 Complete with TS 13 handset.....\$14.95 ea.
 2 for \$27.50

Shipments F.O.B. warehouse. 20% Deposit on orders. Minimum order \$5.00. Illinois residents, add regular sales tax to remittance.
 Prices subject to change without notice.

R W ELECTRONICS Dept. N, 1712-14 S. Michigan Ave., Chicago 16, Ill. PHONE: HARRISON 7-9374



Print Your Own

Cards, Stationery, Advertising, labels, circulars, photo and movie titles, church work, tags, etc. Save money. Sold direct from factory only. Raised printing like engraving, too. **Print for Others, Good Profit.** Have a home print shop. Easy rules supplied. Pays for itself in a short time. Write for free catalog of outfits and all details.
KELSEY PRESSES, B-72, Meriden, Conn.



LOOK!
**KLIPZON
 FREES
 BOTH HANDS!**

UNIQUE SELF-HOLDING POINTS
 bring new convenience
 and timesaving to service work.

- * V.H.F. CRYSTAL PROBES * ADAPTORS
 - * STREAMLINED TEST PRODS * CONNECTORS
 - * LOW LOSS — LOW CAPACITY LEADS
- See KLIPZONS at your distributor.
 Send for FREE folder #36.

UNITED TECHNICAL LABORATORIES
 Engineers • MORRISTOWN, N. J. • Manufacturers

ON THE SPOT BATTERY RECORDER

WALKIE-RECORDALL 8 lb. miniature BATTERY RECORDER-PLAYBACK
 Continuous, permanent, accurate, indexed recording at only 5c per hr. Instantaneous permanent playback. Picks up sound up to 80 ft. Records conferences, lectures, dictation, 2-way phone & sales talks; while talking, riding or flying. Records closed circuits with "hidden mike"! Write for Detailed Literature.

MILES REPRODUCER CO., INC.
 812 BROADWAY Dept. RN-1, NEW YORK 3, N. Y.

TANNOY

The Sensation of the New York Audio Fair!

Great Britain's Finest Speakers Hand-Made By Master Craftsmen To Precision Standards.

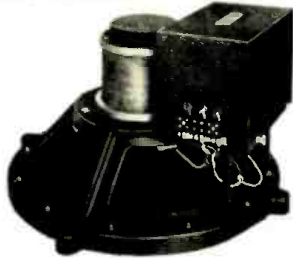

Exclusive With Sun Radio in New York!

Now you can experience amazing wide range response in perfect balance. Hear the world-famous Tannoy Dual Concentric Loudspeaker System, providing optimum fidelity at any level from the audible threshold up to full room volume. So outstanding in performance that Hi-Fidelity Magazine-December 1952 issue. Substantially flat response from 40-20,000 cps. Concentric sources for both HF and LF components avoiding interference at crossover. HF horn formed by machined center-pole and LF diaphragm, these combined with a special throat insure correct HF match. Intermodulation product less than 2%. Very wide angle of high frequency distribution. You owe it to yourself to hear these instruments before making any choice.

Check These Outstanding Features

12" Dual Concentric Loudspeaker
 Power handling capacity 15 watts.
 Impedance via crossover network 18 ohms.
 Crossover frequency 1,700 cps.
 Overall diameter of frame 12 7/8".
 Overall depth 7 1/2".
 Substantially flat response 35-20,000 cps.
 Weight 25 lbs. with crossover network.

Complete with crossover network **\$130.00**

15" Dual Concentric Loudspeaker
 Power handling capacity 25 watts peak.
 Impedance via crossover network 15 ohms.
 Crossover frequency 1000 cps.
 Overall diameter of frame 15 1/4".
 Overall depth 11".
 Substantially flat response 40-20,000 cps.
 Weight 30 lbs. including crossover.

Complete with crossover network **\$159.00**
 Mail Orders promptly filled. Send 25% deposit with your order.

SUN RADIO FEATURES

- All famous-name brands.
- Complete hi-fidelity sound studio.
- Courteous service, no high pressure.
- Free technical advice.
- Free cabinet installation.
- Pre-tested components and systems.
- Free coded connecting cables for easy component assembly.
- Prompt delivery.
- Lowest prices.

FREE! New Edition

Before buying hi-fidelity equipment check Sun's new 100-page catalog. The most complete publication of its kind in the industry. This 1953 edition, just off the press, will answer all your questions. Sun Radio is hard to beat for quality and price. So don't delay, write today or come in for your free copy.

Sun Radio
 & ELECTRONICS CO., INC.
 122-G DUANE ST. NEW YORK 7, N. Y.

Open daily to 6, Saturday 9-4:30.

end of the QSO. In order to meet these requirements, the modulator was designed to offer "broadcast" fidelity, supplying approximately ten watts of undistorted peak voice power to the carrier from an unusually small package.

Exclusive use of miniature dual triodes results in the smallest practical size for the modulator. With reference to Fig. 7, note that a single cascaded 12AX7 comprises the speech amplifier for a crystal microphone. An r.f. decoupling filter, R-C, serves to isolate r.f. from the speech input grid.

The shunt-coupled UTC 0-6 "Ouncer" transformer drives a 12AT7 amplifier; this dual triode provides push-pull amplification to drive a second 12AT7 cathode-follower stage which, in turn, drives a 12AU7 as the class B modulator. Use of the cathode-follower driver tube eliminates the necessity for a driver transformer, an item of some importance where space is at a premium.

Any type of small modulation transformer designed for 10,000 ohm plate-to-plate class B service may be employed rather than the unit recommended, the prerequisite being that its secondary should encompass an impedance range of 3000 to 5000 ohms to match the class C load. The transformer used provides three secondary taps of 3000, 3750, and 4500 ohms. At a plate voltage of 300 and loaded to 70 ma., the class C load represents 4643 ohms, matching the 4500 ohm tap closely enough to result in linear modulation.

Power supply for the modulator remains identical to that required for the r.f. section, although its current rating need not exceed 100 ma. The 12AU7 has a static plate current of 15 ma. with -22 1/2 volts of battery bias and peak current of 75 ma. Oscilloscopic inspection of the 20-watt carrier shows linear modulation of approximately 97%, while signal reports place special emphasis upon the excellence of quality and the power-packed audio sidebands.

Fig. 6 illustrates modulator construction; a case measuring 10" long, 3 1/4" deep, and 3 1/2" high encloses the complete unit. Parts layout follows schematic circuitry down a straight line from input to output; components bolt to a strip of aluminum "breadboard" which mounts above the bottom of the case upon four corner stand-off spacers. Fig. 2 shows the breadboard inverted to illustrate the wiring technique and parts placement.

When constructing the modulator, it will be found that point-to-point wiring becomes necessary, as the compactness of the unit is similar to that of a hearing-aid amplifier. Extreme caution in wiring will result in the least feedback in a high-gain system of this size. When operating properly, the gain control may run wide open with zero feedback, although this offers more gain than is required for the normal modulation of 20 watts input.

WALDOM

SUPERIOR COMPONENTS

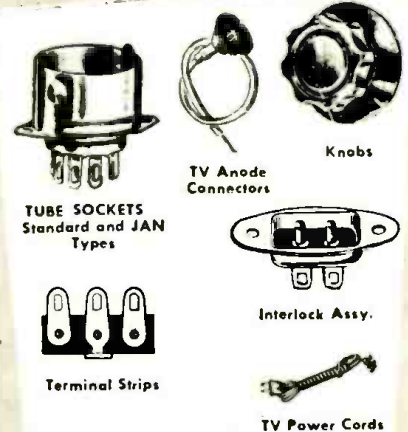

WALDOM also supplies quality **CRONAME** parts

- TV Mask, Glass and Escutcheon Kits.
- Croflex Tuners
- Escutcheons
- Title Plates
- Dial Plates
- Switch Plates
- Radio Knobs
- Instrument Drives
- Instrument Dials

FREE
 SEND FOR 1952
WALDOM
CATALOGS

#32—WALDOM Superior Electronic Components and CRONAME Products.
 #52—WALDOM Replacement Speaker Cone Manual.

WALDOM ELECTRONICS, INC.
 911 N. Larrabee St., Chicago 10, Ill.

YOUR BEST TV SERVICING GUIDE

TELEVISION AND F-M RECEIVER SERVICING

\$3.25

TELEVISION AND F-M RECEIVER SERVICING

gives you practical information on antennas and transmission lines, complete alignment and servicing instructions. How to diagnose, locate, and correct common troubles as well as install sets for best reception. 248 pages, illustrated.

And Don't Miss

TELEVISION SIMPLIFIED (Kiver).....\$6.50
F-M SIMPLIFIED (Kiver)..... 6.50
U.H.F. RADIO SIMPLIFIED (Kiver).... 4.50

D. VAN NOSTRAND COMPANY, INC.

Order from your parts jobber today, or write direct to D. Van Nostrand Company, Inc., 250 Fourth Avenue, New York 3, New York. Please send me the following books:

- Television Servicing Television Simplified
 F.M. Simplified U.H.F. Radio Simplified

I enclose \$.....
 Name
 Address
 City Zone..... State..... RTN-153

RADIO & TELEVISION NEWS

Two insulated mounting strips attach to the top of the modulator case at each end. The r.f. chassis grounds to one point only on the modulator case to foil v.h.f. circulating currents flowing between the metals. (Those circulating currents can cause untold grief by contributing to excessive r.f. feedback!) In addition to providing insulation, the strips are saw-slotted to afford footing for the bottom edges of the r.f. chassis, preventing slippage.

The case and r.f. chassis are fabricated from heavy brass plate, silver-plated, and polished. It is emphasized that this development model was silver plated not to enhance its electrical characteristics, but only to satisfy an aesthetic whim of the designer! The reader may construct a similar transmitter upon pewter or platinum, depending upon his taste and the size of his bankbook.

In constant use for the past several months, this transmitter has worked the same DX as have stations using more than five times its power input of twenty watts. Ninety-five per cent of the DX contacts were solid QSA 5, using a four-element beam from a flat city location. This operation indicates that at W6WGD, a hilltop and kilowatt seem unnecessary for more than routine enjoyment of the two-meter band.

"THE BACKTRACKER"

By JOHN M. HAMILTON

WITH grounded plate and cathode, no grid leak nor "B" supply, maybe our little set, "The Backtracker," shouldn't work at all; yet it does, bringing in local and DX stations with plenty of head-phone volume.

The set was built around a discarded Type 56 receiving tube (any other indirectly-heated tube will work), which obviously operates as a "square law" detector. The two coils shown in the circuit diagram form a grid-plate coupler, which increases the sensitivity and selectivity.

Coil L₁ consists of 100 turns of #28 enamel wire on a 1½-inch cardboard tube. L₂ consists of 300 turns of #28 on a 1¼ inch form. L₂ slides inside of L₁ to form the coupler.

Tuning is easy. Rotate the condenser until a station is heard; then pull out L₂ until the volume is strongest. The frequency may be changed considerably by pulling out L₂ several inches.

From our home in Youngstown, Ohio, using an ordinary 70-foot aerial, we've logged 27 broadcast stations. Our best DX so far is KOA, Denver, 1500 miles away—logged in the wee hours!

Complete schematic of a simple one-tube set.

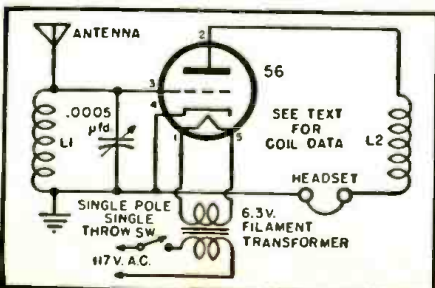

January, 1953

TRAIN At Home FOR OPPORTUNITIES IN UHF-TV SERVICING

Set Your Own Pace with This Practical Program!

Get in on the ground floor of this fast-growing field. Train now to cash in on the opportunities that are yours in UHF-TV SERVICING with proven, practical T.C.I. training. Here is non-mathematical training that's complete down-to-earth up-to-the-minute. Here is training you take in your spare time, without leaving your present job! Think of it—in your own home you learn TV set conversion, master antenna installation, the latest in UHF-TV, money-making short cuts and much more. You learn to trouble-shoot, test and repair TV sets the only practical way—by actually doing this work yourself!

HERE'S HOW YOU LEARN BY DOING!

You get the experience you need by working on a large screen, modern TV receiver that's given to you with the course and is yours to keep. As an optional feature you get two weeks of field experience on service calls and on the repair bench with one of Chicago's largest independent TV servicing organizations. You profit from the experience and know-how of men in the field. Not through books alone but by actually doing the work yourself, you get the knowledge you need to qualify for opportunities

VETERANS discharged since June 27, 1950 are eligible for G.I. benefits. Check coupon.

TELEVISION MAIL NOW FOR FREE BOOKLET
 Communications Institute
 205 W. Wacker Dr.,
 Dept. 1-AE, Chicago 6, Ill.

THESE MEN LIKE YOURSELF SAY T. C. I. TRAINS YOU BEST!

"I've almost completed your course now, but I have been servicing TV sets since almost the beginning of the course."
 E.R.M., Rhode Island.

"Thanks to your course, jobs that used to take me several hours now take but a few minutes to complete."
 W.L.K., Wash.

"I like the easy way your lessons are presented. I'm very pleased with your course and have recommended it to a friend."
 L.R.S., Texas.

TELEVISION COMMUNICATIONS INST.
 205 W. Wacker Dr., Dept. 1-AE, Chicago 6, Ill.
 YES! Rush full facts on UHF-TV training. Include FREE Catalog and Sample Lesson. I am not obligated. Salesman will not call.

Name Veterans Check here
 Address
 City Zone State
 BEGINNERS: Check here for information on Pre-TV Radio Course.

60 CYCLE AC SYNCHRONOUS MOTOR (115V) Part of Watt-hour Meter movement, loaded with matched gears, worms, etc. . . . \$1.95

44 FLEXIBLE SHAFT & HOUSING . . . \$1.49
 female setscrew ¼" x ¼" tip

33 CONTACT CONNECTORS (Jones 33) . . . \$1.29; 5/\$5.00
 female; panel male. Off cable-set

SPEAKER ACCESSORIES . . . \$1.98
 MENT CONES . . . 4" to 12" incl. free, edge
 Less voice coils. 12 ass'd.

SPEAKER REPAIR KIT . . . \$2.49
 Professional assortment of Rings, Spliers, V.C. Ferrules, Fel., Chamois, Leather, Cement, Shim Kit & Instructions.

BOTH CONE & REPAIR KITS FOR ONLY . . . \$3.95

GRILLE CLOTH . . . Beautiful Gold weave, 19" x 21" . . . \$2.69

ORNAMENTAL METAL GRILLE . . . \$4.50
 Brushed Brass finish; diamond design (2" x 8")
 12" x 12" . . . \$4.95; 18" x 18" . . . \$1.39;
 10" x 10" . . . \$1.59; 22" x 22" . . . \$3.75

ACOUSTICAL FELT CABINET LINING . . . \$1.98
 12" x 12" x ¼" laminated. Separates to give 3 sq. ft.—ea. 39¢

RADIO HARDWARE TREASURE . . . FULL LB.
 CAN OF Nuts, screws, Washers, etc. . . \$0.89

"POLYSTYRENE" . . . 12" (rths. ROY) . . . \$1.25
 10c; 20c; ¼" . . . 38c; ¾" . . . 55c; 1" . . . 79c

TUBING (O.D.) . . . 10c; ¾" . . . 12c; ½" . . . 17c; 3/8" . . . 23c; 1" . . . 27c; 1 1/8" . . . 36c; 1 1/4" . . . 41c

SHIELDED PHONE WIRE . . . coils 20-80 ft. Per Ft.03
 = 20 PUSH-BACK WIRE . . . Red, Yel., Blue or Blk. 100 ft.89

SOUND-POWER PHONE UNITS (AMB-H-1A) . . . \$1.95; 5/\$3.49
 Hi-fidelity. Use as mike or rec'r. up to 300 ft.

CRYSTAL HEADPHONES (Brush Type "A") 50K ohm imp'd. 5 ft. tipped cord. . . . \$4.95

PORTABLE RADIO AMPLIFIER CABINET . . . Ident. for: 100. Medical or Industrial Dept. Walnut finish steel. Hinged front panel; sliding rear panel. 14" x 8" x 8". Shpg. wt. 14 lbs. . . . \$2.49

PERMEABILITY TUNER . . . STD. B'CAST . . . \$0.98
 Sing-tuned. Ant. & Dec. coils; one. handle.

T-30 THROAT MIKE with neckband. PR-29169
 EXT. CORD & SWITCH for T30 mike. Less P16849c; 10/4.50

T-44A MAGNETIC MIKE (R24) . . . Press-to-talk switch in cord. With P168 type plug1.98

HANDY CARBON MIKE (RS83) . . . Press-to-talk switch in cord. With P168 type plug1.98

TUBE CARTONS . . . Plain white. Prices per 100: Min (1 1/2" x 1 1/4" x 2 1/2") . . . \$1.20; GT (1 1/2" x 1 1/4" x 1 1/4") . . . \$1.45; Med (1 1/2" x 1 1/4" x 4 1/4") . . . \$1.65; Large (1 1/2" x 2" x 3") . . . \$1.98; Extra Lge. (2 1/4" x 2" x 6 1/4") . . . \$3.95

"BIGGEST BUY OF THE MONTH!"
"JUMBO RADIO PARTS KIT" . . . A "Gold-Mine" of inventory odds & ends. COILS, RESISTORS, SOCKETS, WIRE, SWITCHES, CONDENSERS, HARDWARE, CONTROLS, ETC., ETC. . . \$3.95
 Shpg. wt. 20 lbs.

"DIRECT FACTORY SPEAKER REPAIRS SINCE 1927"
 Min. order \$3.00. 20% deposit req. on all C.O.D.'s. Full remittance with foreign orders. Please add sufficient postage—recess refunded.

LEOTONE RADIO CORP.
 67 Dey Street
 New York 7, N.Y.

What to look for in a record changer...

**PRACTICAL • STURDY
 PUSHER-TYPE PLATFORM
 ON ALL MODELS**

Always works Gentle to records

Simple to adjust for all record sizes

One of many features which make

GARRARD

The World's Finest
 3 Speed Record Changer

Fully automatic with automatic stop Can be used with your present set.

MODEL RC 80

Garrard Sales Corp. Dept. R-1
 164 Duane St., N. Y. 13, N. Y.
 Send GARRARD Fact Sheet.

Name.....
 Address.....
 City.....Zone.....State.....

\$42.90 net
 less cartridge

Amazing Performance!

MATTISON

SILVER ROCKET 630 CHASSIS

• with **TUNEABLE** •

BUILT-IN BOOSTER
for Better DX Reception

Featuring **NEW CASCODE TUNER**
made for UHF interchangeable
tuning strips and 70° COSINE YOKE

Tube
Complement:
28 tubes
3 rectifiers
1 CRT

32

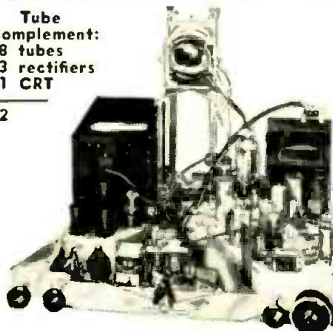

All Channel Booster

• Broad band single knob control pre-amplifier built in to eliminate long leads which may cause regeneration and attenuation of signal.

• **ONLY THE MATTISON 630 CHASSIS HAS AN ALL CHANNEL TUNEABLE BUILT-IN BOOSTER THAT INCREASES SIGNAL STRENGTH UP TO 10 TIMES. THE SILVER ROCKET WILL OUT-PERFORM ANY CHASSIS MADE AND IS PRICED RIGHT TO SELL FAST WITH AN EXTRAORDINARY MARGIN OF PROFIT FOR YOU. WRITE FOR CONFIDENTIAL PRICE SCHEDULE.**

• Mattison features a complete line of cabinets MADE IN MATTISON'S OWN CABINET FACTORY. 36 breathtaking designs that blend perfectly in any setting, traditional or modern.

All
Cabinets
Made in
Mattison's
Own
Cabinet
Factory!



The BERKSHIRE 21"

Genuine Mahogany. Deeply paneled 1 1/8" thick doors. Crotch Mahogany design and Hi-light shading throughout. Illuminated channel selector. Chassis is side mounted. Dimensions: height 40", width 32 1/2", depth 23 1/2".

DEALERS! SERVICE DEALERS! Here is your opportunity to become the "important" TV Dealer in your area for THE FINEST CUSTOM-BUILT LINE OF TV RECEIVERS. FREE!! Write for Mattison's merchandising portfolio explaining the "UNASSEMBLED PLAN" and "1,000,000 FLOOR PLAN."



Manufactured with integrity

When you buy from Mattison you need only one source of supply! You can buy a Mattison Chassis, a Mattison Cabinet or a complete Mattison TV Set!

Mattison Television & Radio Corp.

10 West 181st St., Dept. RN, N.Y. 53, N.Y.

RADIO-TV Service Industry News

AS REPORTED BY THE
TELEVISION TECHNICIANS LECTURE BUREAU

WHEN officials of manufacturing organizations attend gatherings of people now engaged in the business of servicing radio and television receivers they express amazement at the evident high caliber of the men who own and operate today's service businesses. In the eyes of too many people in the industry who seldom come in direct contact with present day service business executives, the servicing of television and radio receivers is still handled by a faceless, motley mass of people who, in the aggregate, constitute a tremendous market for replacement parts, tubes, and supplies, but whose identity as individuals is of no consequence. Many people still hold the mental picture of the average individual service business operator as being an unkempt character who is content to work for a marginal income and who is either not interested or incompetent to run his service activities in a business-like manner.

A Distributor's Party

A few weeks ago we were invited to attend a parts distributor's party for his service customers. This was something new. There are endless parties given by manufacturers for their distributors and by the distributors for the representatives, and vice versa, but this was the first time we had had an opportunity to attend a party given by a parts distributor for his service cus-

tomers and their wives and sweethearts.

Seven years ago a former radio service technician started a parts distributing business in Columbus, Ohio. Ray Whitehead and his wife and partner, Polly, launched the infant business in a modest-sized storeroom not overly stocked with replacement tubes, parts and supplies. The business grew rapidly and on their fifth anniversary, the Whiteheads threw a party for the service business customers in central Ohio whose purchases were responsible for the success of the business.

They held another party on their seventh anniversary. They rented the ballroom of a popular hotel to entertain their customers and rented all of the other rooms on the same floor so their suppliers could display the latest products and meet the Whitehead customers. Enough chairs to seat eight hundred people were set up in the ballroom and another two hundred in an adjacent room to accommodate any additional guests who might attend.

The expression "the place was bulging at the seams" is the only adequate description of the tremendous crowd of service people and their wives who accepted the Whiteheads' invitation to attend their anniversary party. Possibly more than 1500 service executives, technicians, and their wives came. It was not a "sales meeting"—it was a gesture of appreciation on the

Part of the crowd of more than 1500 service executives, technicians, and their wives who attended the service party given by Whitehead Radio Company, Columbus, O.



RADIO & TELEVISION NEWS



a Gem

a Gem IN PERFORMANCE

- (a) Long Life
- (b) Good Regulation
- (c) High Efficiency

a Gem FOR VERSATILITY

- (a) Wide Range of Power Outputs
- (b) Temperatures of -55°C to $+100^{\circ}\text{C}$
- (c) Impervious to all Humidity
- (d) Impervious to Salt Atmosphere

a Gem IN COMPACTNESS

- (a) Various sizes and shapes
- (b) Light Weight for any Power Output
- (c) "Tailor-made" for Individual Requirements

Write Janet for your free copy of the booklet on Sarkes Tarzian Embedded Selenium Rectifiers



RECTIFIER DIVISION

Dept. R-1, 415 North College Ave., Bloomington, Ind.

January, 1953

part of a man and his wife to the customers who had made their success possible.

Close to one hundred manufacturers' representatives and company officials attended the party. It was high-lighted by the surprise presentation of a Certificate of Appreciation to John T. Thompson, replacement tube sales manager for GE, for his company's consumer campaigns on behalf of the independent service profession. The presentation was made by Fred Colton of *Graham & Colton*, president of the Associated Radio & Television Service Dealers, Inc., as an award from the Association.

Ray and Polly Whitehead were also surprised with an ARTSD Certificate of Appreciation which was presented by Sam Oppenheimer of the *Columbus TV Laboratories*, vice president of the association.

Lesson in Cooperation

For many years Columbus, Ohio, has been one of the "cleanest" radio-TV service areas in the country. When the TV boom struck it attracted, as in all other areas, some "fast-dollar" and quick change service operators. But down through the years the ARTSD had created a healthy respect for the quality and high standard of service performed by its members. They were able to get the whole-hearted support of the Better Business Bureau and other civic organizations in weeding out the parasites who were trying to feed off the ignorance of the set-owning public about what they should pay for and receive in the way of competent TV service.

There are two important factors back of the continuing success of the Associated Radio & Television Service Dealers in maintaining a healthy climate for radio-TV service as a profitable business activity in Columbus. The first is the amount of time that is given by its officers to create and carry out the Association's programs. These well-conceived programs regularly cover all facets of interest to the men engaged in the business of service. First, they hold their regular monthly sessions where they discuss frankly all phases of the operation of their businesses and all factors that influence the course of their businesses; next they conduct a regular series of technical sessions to keep their members and their members' employees abreast of the fast-growing technology of the industry; and third, they have regular social gatherings that enable the members' families to get acquainted.

The second important factor in ARTSD's success is the excellent cooperation between the Association and Columbus parts and set distributors. Every three months the members of ARTSD invite all Columbus distributors to have dinner with them and afterwards air their grievances against each other. Columbus distributors have cooperated whole-heartedly in this program and it is quite possible that, as a result, Columbus is a poor

Makes
TV
Servicing
easier
to
learn!



BIGGEST \$4 WORTH IN TV TRAINING HISTORY!

PRACTICAL TELEVISION SERVICING

By J. R. Johnson and J. H. Newitt
334 pages, 253 helpful illustrations

HERE, for only a small fraction of the price you might expect to pay is concise, clearly understandable television training of the most practical sort! It is the ideal book for those who already know something about basic radio service and now want to forge ahead in the better-paid television field.

First you learn where and how TV differs from radio. You learn what equipment is needed and where and how to use it properly on all kinds of TV jobs. Every phase of troubleshooting is explained from a practical, on-the-job standpoint—NOT by a lot of confusing mathematics and meaningless theory. For instance, many pages of PRACTICAL TELEVISION SERVICING are devoted to locating many common troubles just by visual observation.

DATA BASED ON ACTUAL SERVICE SHOP EXPERIENCE

Dozens of actual service case histories help make puzzling jobs easier to handle. Over 250 illustrations and pattern photos explain details step by step. Other subjects include component replacement data, wiring details, helpful hints on testing and information on subjects from fringe area reception to improving picture linearity in difficult locations.

The book that
helps radio men
CASH IN ON
TV SERVICE
PROFITS!

Covers every phase
of television

**CONSTRUCTION
OPERATION
VISUAL TROUBLESHOOTING
INSTRUMENT
TROUBLESHOOTING
SERVICING
COMPONENTS
COMPONENT
REPLACEMENT
PATTERN
ANALYSIS
SHOP HINTS, etc.**

A great book to
help you pass
TV service
license
examinations!



READ IT 10 DAYS . . . AT OUR RISK!

Dept. RN-13, RINEHART BOOKS, INC.,
Technical Division
232 Madison Ave., New York 16, N. Y.
Send PRACTICAL TELEVISION SERVICING for
16-DAY EXAMINATION. If I decide to keep the
book, I will then remit \$4.00 plus a few cents postage.
Otherwise, I will return book postpaid and owe you
nothing.

Name
Address
City, Zone, State
Employer's Name & Address.....
OUTSIDE U. S. A.—Price \$4.50 cash only. Money
back if book is returned in 10 days.

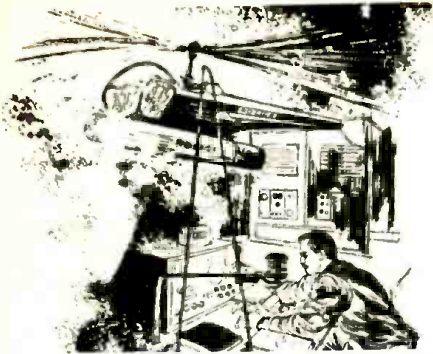

NEW NEW NEW NEW

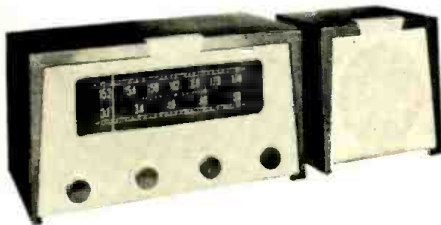

MONITORADIO MODEL OR200

Model DR200 Two Band Communications Receiver newly developed—low cost—only one of its kind. Fixed and Tunable Combination AC Receiver for 30-50 MC and 152-174 MC.

Operating in two pertinent fixed frequency ranges the tunable feature can be used alternately with the flip of a switch.

Ideal for expanding communications systems of municipal police, civil defense, fire, forestry, state police, pipelines, taxis.

Built-in sensitive squelch with level control. Dual conversion, 10.7 MC and 455 KC. Fully tuned RF stage. Fourteen tubes plus rectifier. Sensitivity for 20 DB quieting, one microvolt low band, two microvolts high band. Selectivity 3 DB at plus or minus 20 KC, 80 DB at plus or minus 30 KC. Crystal selector control with provision for two crystals fixed frequency operation (one for each band).



MONITORADIO MODEL MR 32 AC RECEIVER FOR 30-50 MC

RADIO APPARATUS CORPORATION
55 NORTH NEW JERSEY STREET
INDIANAPOLIS 4, IND., PHONE: ATLANTIC 1624

MONITORADIO

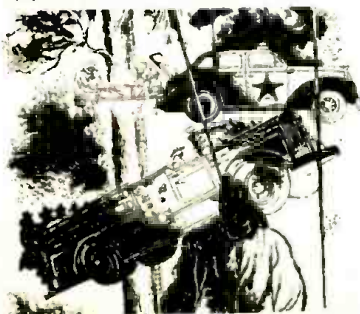

burton brown advertising

market for fringe distributors and the extra discount boys in the distributor business.

Why Do Service Associations Fail?

Many service associations have been formed with a great deal of enthusiasm only to quickly wither and die from ennui. Why? The first reason is that associations usually are formed when service businesses are in trouble. Those who join think an "Association" will solve their troubles. Usually, the first acts of an association are along the lines of "forcing" someone to do something or to quit doing something that the members think is hurting their businesses.

For an association to be successful it must first be ready to "give" something to the industry in which it operates. Its members must be willing first to get their own business houses in order before they start asking others to clean up theirs.

A successful organization must have a series of self-help programs. These must be carefully planned, intelligently organized, and carried out aggressively. This requires time, effort, and thought on someone's part. It also takes money. If the officers of an association are not willing—or not able—to give unstintingly of their time and effort to develop and carry out these self-help programs the organization will wither away. If the members are unwilling to pay the dues necessary to defray the expenses necessary to operate an association it cannot exist.

The first requirement of an association is to have a carefully planned series of activities that will cover the business phases of a service company and the technical developments in the industry that affect service, and will provide an opportunity for the members to get acquainted socially. The second requirement is for the association to have an officer, or officers, who can afford to give the time and have the natural "drive" to keep this program rolling.

All too often after an association is formed the members are too busy to engage in association activities when business is good and they can't afford it when business is bad.

A Case History

The Television Service Association of Michigan is a comparatively new organization that has created an important place for itself in the TV industry in Detroit. Like ARTSD and other successful associations, it is primarily concerned with the problems of service as a business but at the same time, keeps its members and Detroit technical service personnel abreast of technical developments by sponsoring service clinics and lectures.

TSA has the active support of both set and parts distributors in the area and they work closely with the Better Business Bureau and law enforcement agencies in policing service business practices in the city.

MERIT POWER TRANSFORMERS	
115 VOLT 60 CYCLE PRIMARY	
120V/50 MA/6.3V-1.5 AMP	\$ 2.73
150V/25 MA/6.3V-5 AMP	1.76
480VCT/50 MA/6.3V-25 AMP	3.23
480VCT/40 MA/5V-2 A/6.3VCT-2 A	3.53
520VCT/70 MA/5V-2 AMP/6.3V-3 AMP	4.53
700VCT/90 MA/5V-3 A/2.5 VCT-12.5 A	5.88
650VCT/40 MA/5V-2 A/6.3VCT-2 A	3.67
700VCT/90 MA/5V-3 A/6.3VCT-3.5 A	4.70
700VCT/120 MA/5V-3 A/6.3VCT-4.7 A	5.44
750VCT/150 MA/5V-3 A/6.3VCT-5 A	7.05
800VCT/200 MA/5V-3 A/6.3VCT-5 A	8.23
870VCT/250 MA/5V-3 A/2.5V-10 A/6.3VCT-3 A/6.3 or 5V-3 A/80 V BIAS TAP	10.29
700VCT/225 MA/5V-3 A/6.3V-10 A/6.3V-2.7 A*	12.49
724VCT/295 MA/5V-6 A/12.6VCT-5-A/5V-2 A*	16.12
700VCT/200 MA/5V-2 AMP/5V-3 AMP/6.3V-6 AMP/6.3V-7 AMP	10.58
800VCT/300 MA/5V-3 A/5V-6 A/12.6VCT-10 A*	17.64
1750V/2 MA/2.5V-2 A/6.3V-9 A/6.3 or 2.5V-2 A†	6.17
2500V/5 MA/2.5V-2 A/6.3V-3 A/6.3 or 2.5V-3 A†	8.23
† HALF SHELL MOUNT * TV REPLACEMENT	
‡ UPRIGHT MOUNT	
CONSTANT VOLTAGE TRANSFORMERS	
95-130 VOLT 60 CYCLE INPUT	
115 VOLT 60 CYCLE OUTPUT ± 1/2%	
15 WATT	\$15.68
30 W (6.0 or 7.5V OUT)	17.64
120 WATT	32.34
500 WATT	79.38
30 WATT	\$ 17.64
60 WATT	24.50
250 WATT	50.96
1000 WATT	132.30
2000 WATT	240.10
SELIUM RECTIFIERS	
SINGLE PHASE—FULL WAVE BRIDGE STACKS	
MAX. AC INPUT—26 V/6-20 V DC OUTPUT	
2 AMP	\$4.99
4 AMP	6.70
6 AMP	7.20
8 AMP	8.68
MAX. AC INPUT—130 V/100-120 V DC OUTPUT	
.5 AMP	\$10.26
1 AMP	16.34
2 AMP	21.56
4 AMP	32.40
6 AMP	\$33.30
8 AMP	44.64
12 AMP	46.62
STEEL BOXES—BLACK CRACKLE FINISH	
4 x 4 x 2	\$.70
4 x 5 x 3	.80
6 x 6 x 6	1.10
12 x 7 x 6	2.08
15 x 9 x 7	\$2.38
12 x 7 3/4 x 6 1/2	2.40
12 x 7 3/4 x 6 1/2	2.48
SLOPING FRONT CABINETS	
8 x 8 x 8	\$3.53
8 x 10 x 8	3.93
8 x 12 x 8	4.08
8 x 14 x 8	\$4.23
12 x 18 x 12	7.70

All prices F.O.B. our warehouse New York

LEEDS RADIO CO.

75 Vesey St. Dept. A New York City 7

MAKE DIM TUBES LIKE NEW AGAIN!

WITH
PICBOOST
ONLY
\$1.95



Dim TV tubes spring back clear and bright again. Just plug in. No soldering—No fuss—Takes less than a minute to install. Will give any TV tube 3,000 more hours of bright life.

Eliminates big C. R. tube inventories, excessive service trips—a real help for second year TV contracts. See how Picboost saves you real money. Try it yourself. Order Picboost today!

10% Cash with Order

ALMO RADIO CO.

509 ARCH ST. & 6205 MARKET ST.
Philadelphia, Pa.
6th & ORANGE STS. • Wilmington, Del.
4401 VENTNOR AVE. • Atlantic City, N. J.
1133 HADDON AVE. • Camden, N. J.
219 Highland Ave. • Salisbury, Md.



RU-18 RECEIVER

Navy 6-tube aircraft receiver with DF loop and antenna input; complete coverage from 190 KC to 13.9 meg.; in 8-coil sets, less tubes; brand new with any 5-coil sets; you name the frequency you desire; F.O.B. shipping wt. 2.25 lbs. \$19.95

McCONNELL'S 3834 Germantown Ave. Phila., Penna. RA 5-6033

RADIO & TELEVISION NEWS

Hal Chase of Chase Television Service, president of the Association, gives a lot of his time in planning and directing the Association's activities. "TSA News" has been developed into a self-supporting house organ with a wide circulation in the area. Recently they launched a "consumer" bulletin which is included as a section of "TSA News." It is available in quantities to members for mailing to their customers. The consumer bulletin carries TV-connected news of interest to set owners and is supported by merchants who advertise in it.

The Association holds regular monthly business meetings. These are held in a private dining room in a downtown hotel with members and guests meeting for dinner. After dinner a guest speaker usually gives a short talk on some subject of immediate importance to service executives with the regular business meeting and round table discussion of problems following it. Parts and set distributors attend these monthly business meetings.

The technical meetings include at least one general service clinic each year. The purpose of the service clinics is to permit technicians to get circuit information on all standard TV sets in as short a time as possible. Distributors display their latest model chassis and have either factory or distributor service personnel on hand to discuss circuit individualities with service technicians.

TTLB Lecture on U.H.F. TV

The TSA recently sponsored the Television Technicians Lecture Bureau's lecture on u.h.f. TV. In this type of lecture the technician is able to get a complete picture of all possible installation and servicing requirements that may be demanded for u.h.f. reception. It covers u.h.f. converters and how they are applied to present v.h.f. receivers. Sample units of most converters are displayed and alignment procedures are demonstrated for the converters that may need to be aligned in the field.

The presentation then covers the circuitry of the new u.h.f.-v.h.f. combination receivers and technicians are shown what they may be called upon to do in servicing these new sets in the field. And, since the antenna system may possibly be the most important element in the reception of u.h.f. programs, either in converted v.h.f. sets or in the new u.h.f.-v.h.f. combinations, an extensive coverage of u.h.f. antenna and systems requirements is included as a part of the lecture.

These technical training programs as carried out by TSA and ARTSD are planned to conserve a technician's time by giving him the maximum amount of practical information in a minimum of time.

Business or Technical Associations?

Television introduced a new factor in the operation of service businesses that has made a complete change in

January, 1953

Become an ELECTRICAL ENGINEER in 36 MONTHS

Bachelor of Science Degree — Major in Electronics or Power

It is estimated by 1955 there will be at least two positions for every engineering and technician graduate. This college offers a tested plan that permits you to enter these vast employment opportunities at an early date. Save a valuable year through optional year-round study. Receive advanced credit for prior training gained in the armed forces, other schools or field experience.

ENTER BOTH RADIO AND TELEVISION 12 months or one-third of the B. S. degree course (Electronics major) — also brings you the Radio Technician's certificate. An added 6-month course qualifies you for the Radio-TV Technician's certificate. Recent developments open unlimited opportunities for TV technicians and engineers.

THE PROVEN "UNIT CHASSIS SYSTEM" of teaching was developed here. It "breaks down" the TV set by stages. You learn every component of all types and makes — and are prepared for future design changes, including the advent of color.

6 to 12-MONTH TELEVISION SERVICE COURSE... trains for good servicing jobs and shop ownership in the shortest practical time under expert instructors.

Terms open April, July, October, January. Over 48,000 former students from all states and 23 overseas countries. Faculty of trained specialists. Modern laboratories and equipment.

Write for free 110-page catalog, 48-page pictorial booklet "Your Career" and "Occupational Guidance Bulletins."

MILWAUKEE SCHOOL OF ENGINEERING

NONPROFIT • FOUNDED IN 1903



Milwaukee School of Engineering
Dept. RN-153, 1025 North Milwaukee
Milwaukee 1, Wisconsin

Without obligation send Catalog for Electrical Engineering, B. S. Degree, major in Electronics; Power; "Your Career"; Occupational Guidance Bulletin on: Radio-TV; Electrical Power; Welding; Heating, Refrigeration, Air Conditioning; Mechanical Engineering, B. S. Degree; Preparatory; Television Service.

Name..... Age.....

Address.....

City..... Zone..... State.....

If veteran, indicate date of discharge.....

★ STAR SPECIALS

NEWEST ITEMS! LOWEST PRICES!

BARGAIN LOW PRICE

FLYBACK TRANSFORMER

(Similar to GE 77J 1)

Regular \$11.00 list price high voltage transformer similar to General Electric 77J1. Used for general replacement in many sets up to 14KV and with up to 19" tubes. Not available elsewhere at our low price!

A-1827 Flyback Transformer \$2.49



Simpson Model 381 CAPACITY BRIDGE

Direct-reading in micro-microfarads and microfarads; no multiplying factors or intricate switching. Three ranges to read 20-5000 mmf, 0.005-2.0 mfd, and 1.0-500 mfd. Compact bakelite case measures only 3 3/8" x aluminum

5 1/2" x 2 3/8" etched panel. For 115-volt 50-60 cycles. \$27.93

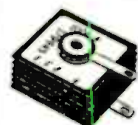

Price Slashed!

65 MA SELENIUM RECTIFIERS

Brand new, famous make 65 ma. selenium rectifiers used by servicemen and builders. Standard replacement for many AC-DC sets and other transformerless power supplies. Stock up now at our low price!

A-1598 65 ma. Selenium Rectifier 65c ea. 10 for only \$5.90! 100 for only \$54.00!

COMPLETE STOCKS All Standard Brands Just off the press BIG BARGAIN BULLETIN



ELECTRONIC DISTRIBUTORS, INC.
Dept. RN1-7736 S. Halsted, Chicago 20, Ill.

South River NEWS

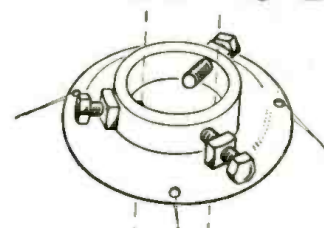

GUY RING Model GR-1

Constructed of heavy gauge, galvanized steel, embossed for extra strength. Set screw arrangement provides positive fit for all masts ranging from 1 1/4" O.D. to 2" O.D. Complete with installation hardware.

Smooth Round Edged Holes Prevent Cutting of Guy Wire

South River Antenna Mounting Accessories are carried by every leading TV Parts Jobber from coast to coast. Write for your copy of our new 1953 catalog.

SOUTH RIVER METAL PRODUCTS CO., INC.

SOUTH RIVER, N. J.

PIONEER AND OUTSTANDING PRODUCER OF FINEST LINE OF ANTENNA MOUNTS

to the

ELECTRICAL ENGINEER

or

PHYSICIST

with experience in

RADAR

or

ELECTRONICS

Hughes Research and Development Laboratories, one of the nation's leading electronics organizations, are now creating a number of new openings in an important phase of their operations.

Here is what one of these positions offers you:

THE COMPANY

Hughes Research and Development Laboratories, located in Southern California, are presently engaged in the development and production of advanced radar systems, electronic computers and guided missiles.

THE NEW OPENINGS

The positions are for men who will serve as technical advisors to government agencies and companies purchasing Hughes equipment—also as technical consultants with engineers of other companies working on associated equipment. Your specific job would be essentially to help insure successful operation of Hughes equipment in the field.

THE TRAINING

On joining our organization, you will work in the Laboratories for several months to become thoroughly familiar with the equipment which you will later help users to understand and properly employ. If you have already had radar or electronics experience, you will find this knowledge helpful in your new work.

WHERE YOU WORK

After your period of training—at full pay—you may (1) remain with the Laboratories in Southern California in an instructive or administrative capacity, (2) become the Hughes representative at a company where our equipment is being installed, or (3) be the

Hughes representative at a military base in this country or overseas (single men only). Compensation is made for traveling and moving household effects, and married men keep their families with them at all times.

YOUR FUTURE

In one of these positions you will gain all-around experience that will increase your value to our organization as it further expands in the field of electronics. The next few years are certain to see large-scale commercial employment of electronic systems. Your training in and familiarity with the most advanced electronic techniques now will qualify you for even more important future positions.

How to apply:

HUGHES

RESEARCH AND
DEVELOPMENT LABORATORIES

Engineering Personnel Department
Culver City,
Los Angeles County, California

If you are under thirty-five years of age, and if you have an E.E. or Physics degree, write to the Laboratories, giving resumé of your experience.

Assurance is required that relocation of the applicant will not cause disruption of an urgent military project.

the complexion of the service industry. Prior to the advent of TV it was entirely possible for an ingenious technician possessed of some business acumen, able to get along well with people, and willing to work long hours, to make a pretty good living out of servicing radios. Not much equipment was needed for radio service work since the characteristics of the conventional a.c.-d.c. circuits were so well known that almost eighty per-cent of the jobs could be completed without the use of even a v.o.m.

TV changed all that. Larger chassis, more tubes per set, multiple circuits, bulky picture tubes, and on the job servicing, plus a number of other factors, made it necessary for the operator of a TV service business to get familiar with work planning, organization of time, and adequate record keeping. The need for precision test instruments, trucks, larger stocks of tubes, parts, and supplies add up to a substantial investment that can seldom be carried by the income from one man's time. So the TV service business man has employees and all of the attendant responsibilities of keeping his help profitably occupied.

TV service adds up to a tremendous dollar volume business. This attracts the attention of men who are not necessarily TV technicians. They are basically business men who know that good management can operate any business at a profit where there is such a large and growing market for the needed service.

Successful TV service operators are businessmen primarily, whose major interests are in selling service, reducing costs of operation, watching inventories, and planning the work of their employees to make a profit from the labor they are buying.

These men need service *business* associations. They need to know their competitors in the service business. They need to cooperate with their legitimate competitors to discourage practices that are both unprofitable and not in the best interests of the owners of TV sets. A good trade association can actually create more business in any given area through programs of user education.

Technical Associations

Then there are many thousands of men employed in servicing who are mainly interested in the technical phases of the business. Lots of men now engaged in TV receiver servicing do not aspire to own their own service businesses. They prefer the technical side of the business and would rather work as a top technician in a good service organization than run their own service businesses.

These men prefer to belong to technical associations where they can discuss circuitry and technological advances with their fellow technicians. We should have more such associations in the industry. Perhaps they could be termed ISE—Institute of Service Engineers. In large cities techni-

RADIO & TELEVISION NEWS

Columbia

GEM OF THE SURPLUS

BC-348 RECEIVER
110 VAC or 24 VDC. Freq.: 200-500 Kc. & 1500-18,000 Kc. Excel. cond. \$99.50
power supply
BC-221 FREQUENCY METER: With 110 VAC BATTERY OPERATED \$125.00
With calibration book, Excel. cond. 99.50
EE-8 FIELD PHONE: Checked out operating. Used cond. \$22.50
SPECIAL PRICE PER PAIR 39.50

DYNAMOTORS 6 & 12 V.
PE-101: 12 or 24 V. in. 400 V. @ 130 ma output. See Dec. '52 CQ for conv. to 6 VOLTS. New, boxed. 5 4.95
PE-103: 6 or 12 V. in. 500 V. @ 160 ma. With filter base & cords. NEW 34.95
BD-77: 12 V. in.; 1,000 V. output @ 350 mils 14.95
DM-35: 12 V. in.; 624 V. output @ 225 mils 22.50
COMMAND RECEIVER DYNAMOTOR: 12 V., used 7.95

WET CELL BATTERIES
24 V. EXIDE AIRCRAFT. New, orig. box \$15.95
12 V. 37 amp @ 5-hr. rate. NEW 12.95
4 V. FOR TV Transceiver. NEW. HOT! 4.95

STOP! Make extra dough NOW by rushing up your new and used radio gear. We buy it fast at peak-high prices. WRITE TODAY!

TRANSMITTER: HC-375. 100 W. Phone or CW. Complete with 24 V. dynamotor, tuning unit, all tubes & plugs. Excel. cond. \$47.50
RADIO RANGE RECEIVER: HC-1206-CM. New 9.95

ARC-5 OR 274-N TRANSMITTERS
2.1-3 mes. \$19.95
4.5-3 mes. Used, good cond. 6.95
5.3-7 mes. 5.50
7-9.1 12.50

ARC-5 OR 274-N RECEIVERS
19-.55 kc. Excel. cond. \$14.95
1.5-3 mes. Brand new 24.50
3-6 mes. Less tubes 6.95
3-6 mes. With tubes 9.95
6-9.1 mes. Brand new 14.95
6-9.1 mes. Used. Less tubes 8.95
MD-7 ARC-5 PLATE MODULATOR. Excel. cond. 14.95
RACK FOR DUAL TRANSMITTER (274-N) 2.95
RACK FOR DUAL TRANSMITTER ARC-5. 3.95
TRIPLE RECEIVER RACK. 5.00
DUAL RECEIVER CONTROL BOX. HC-406. New 2.95
BC-442-A ANTENNA RELAY with 50 mmfd. condenser. Excel. cond. 3.95
COMMAND RECEIVER FLEX CABLE. 9-12 Ft. long 2.95
12 V. COMMAND RECEIVER DYNAMOTOR. New 12.95

BC-625 TRANSMITTER: Part of SCR-522. Freq. range: 100-156 MC. Less tubes. A HOT BUY! \$13.95
BC-624 RECEIVER: Part of SCR-522. Freq. range 100-156 MC. Less tubes. \$19.75
TERRIFIC THE PAIR ONLY \$29.95

ARC-4 VHF TRANSMITTER: For novice, 2-meter, CD, or CAP. All tubes. Excellent cond. SPECIAL \$32.50
All orders F.O.B. Los Angeles. 25% deposit required. All items subject to prior sale.
COLUMBIA ELECTRONIC SALES
522 South San Pedro St. Los Angeles 13, Calif.

Don't Miss a One of the Exciting New Developments in Electronics. Keep Up Your Subscription to RADIO & TELEVISION NEWS
Circulation Dept.
64 East Lake Street
Chicago 1, Ill.

New Electronic Headquarters—**VAN SICKLE RADIO SUPPLY CO.**
1320 So. Cathoun St. Phone E-4136
FORT WAYNE 2, IND.
Please note new address. Eugene Van Sickle, Owner

cal service associations should arrange themselves in small groups so that members can meet regularly at a central point close to their homes. Perhaps twice a year the entire city association could sponsor a big meeting in some central location to hear an outstanding lecturer or plan a service clinic that would feature discussions of the important technical developments or servicing problems.

Service Industry Identification
A common complaint among service shop operators is that manufacturers are not interested in the problems or welfare of the independent service industry. This is not true for the average manufacturer realizes full well that a strong, financially successful servicing industry will provide a healthy, stable market for his product. It is equally obvious that a manufacturer cannot get enmeshed in the problems of the service industry without getting involved with some laws that tell him to keep his nose out of other people's business.

The independent service industry has several unused "tools" available to it that would lift the entire activity to a much higher level of importance in the industry. The most important of these tools lies in the way you order tubes, parts, and supplies from your jobbers. How often do you specify the brand names you want when you order tubes, parts, or supplies?

How important are you in any manufacturer's "chain of distribution"? If you do not order your tubes, parts, and supplies by brand name—and insist on getting the brands you order—you are not important at all. You are merely a small part of a mass market for these products. Your parts jobber is the key man in the manufacturers' chain of distribution because he selects the brands that you accept without question.

Consider this: If you order fifty tubes from your jobber and accept any brand that he supplies, you as an individual mean nothing to any individual tube manufacturer.

But suppose you specified a particular brand when you ordered tubes—and insisted on getting that brand. Then you become very important to that tube manufacturer because your preference for his tubes has placed you on his sales team. Your jobber will become less important in that manufacturer's chain of distribution because he knows that if one jobber will not or cannot fill your order for his brand of tubes you will go to some other jobber who will. You become a very important factor in that manufacturer's distribution chain.

The independent servicing industry would increase its importance immeasurably in the eyes of manufacturers if every service shop operator would specify a particular brand on all tubes, parts, supplies, and accessories he orders from his jobber—and would insist on getting the brands he specifies.

COMPLETE TRAINING FOR BETTER RADIO-TV SERVICE JOBS

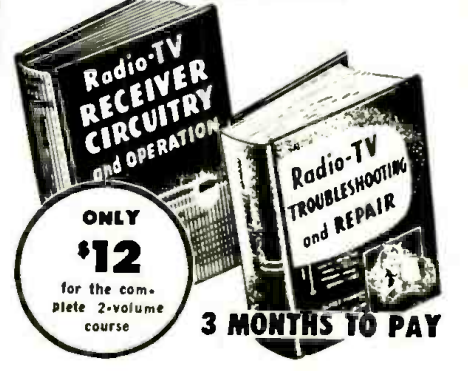

Let these two great new Ghirardi training books teach you to handle all types of AM, FM and TV service jobs by approved professional methods—and watch your efficiency and earnings soar!
Completely modern. Profusely illustrated and written so you can easily understand every word, these books have the way to fast, accurate service on any type of home radio-TV electronic equipment ever made. Each book is brand new, and equipment—NOT a re-hash of old, out-of-date material. Each is co-authored by A. A. Ghirardi whose famous RADIO PHYSICS COURSE and MODERN RADIO SERVICE were, for 20 years, more widely used for military, school and home study training than any other books of their type!

THE NEW Ghirardi RADIO-TV SERVICE LIBRARY

Almost 1500 pages and over 800 clear illustrations show step-by-step how to handle every phase of modern troubleshooting and servicing.

1—Radio and Television Receiver TROUBLESHOOTING AND REPAIR

A complete guide to profitable professional methods. For the novice, it is a comprehensive training course. For the experienced serviceman, it has a quick way to "brush up" on specific jobs, to develop improved techniques or to find fast answers to puzzling service problems. Includes invaluable "step-by-step" service charts. 820 pages, 417 illus., price \$6.75 separately.

2—Radio and Television Receiver CIRCUITRY AND OPERATION

This 600-page volume is the ideal guide for servicemen who realize it pays to know what really makes modern radio-TV receivers "tick" and why. Gives a complete understanding of basic circuits and circuit variations; how to recognize them at a glance; how to eliminate guesswork and useless testing in servicing them. 417 illus., price separately \$6.

New low price . . . easy terms

If broken into lesson form and sent to you as a "course," you'll regard these two great books as a bargain at \$50 or more! Together, they form a complete modern servicing library to help you work faster, more efficiently and more profitably. Completely indexed so you can look up needed facts in a jiffy.
Under this new offer, you save 75c on the price of the two books—and have the privilege of paying in easy installments while you use them! No lessons to wait for. You learn fast—and you learn right!

10-DAY EXAMINATION PRIVILEGE

Dept. RM-13, Rinehart Books, Inc., Technical Division, 232 Madison Ave., New York 16, N. Y.
Send me GHIRARDI'S NEW 2-VOL. SERVICE LIBRARY. I enclose \$3 and will send you \$3 a month for three months until the total price of only \$12.00, plus a few cents postage, is paid. It is understood I may read the books for 10 days. Then, if not satisfactory, I will return them postage paid and you agree to refund my \$3 and cancel the remaining installments. (Books shipped postpaid for full remittance with order—same return privilege.)
Name
Address
City, Zone, State
Employer's Name & Address
OUTSIDE U.S.A.—\$13.00 cash only. Same 10-day return privilege with money refunded.

Ends Low Line Voltage Hazard

CREST LVB-117

Line Voltage Booster

the ultimate in

ACCURATE VOLTAGE BOOST



End low line hazard — sub-normal line voltage may cause damage of TV set or electrical equipment.

The Crest LVB-117* is engineered to restore peak performance to TV set or appliance. Insures full strength, width and height of TV picture. Corrects intermittent sync and oscillator drift. A must for low line voltage areas.

Power plus features of the LVB-117

- ★ 300 watt rating
- ★ Simple external plug-in unit
- ★ Automatically operated, turns on and off with appliance
- ★ Multi-Tap selector assures exact voltage boost
- ★ Overload cut-out protects against line increases
- ★ Visual signal for exact voltage boost

Standard RTMA Guarantee **\$17.95** LIST

Available at local jobbers or write for name of local representative.

CREST

LABORATORIES
INC.

84-11 Rockaway Beach Blvd.
Rockaway Beach, N. Y.
Far Rockaway 7-2732

Tone Controls (Continued from page 57)

equipment and the listener. The general relationships to observe are that phase shift and subsequent mixing tends to lower the apparent frequency of transients and asymmetric waveforms and if the phase rotation is greater than 90 degrees will tend to suppress sine waves. The opposite relationship is when phase shift, inversion, and mixing takes place in which event the apparent frequency of transients and asymmetric waveforms is increased for phase rotations of less than 180 degrees. Likewise, sine waves will tend to be suppressed in the case of phase rotations of less than 90 degrees.

As mentioned earlier, the effect of phase-shift mixing is generally to increase the ratio of transients to sine waves in the reproduction. In addition to some of the previously mentioned advantages this effect may cause reproduction with greater "presence," apparently due to the fact that transients stimulate individual room resonances to a greater degree, an element apparently easily recognized by a listener thoroughly familiar with his particular acoustic environment. Nevertheless, the reproduction of a signal having a high transient-to-sine-wave ratio usually means that the peak power handling capabilities of the audio system must be considerably greater than that of a system handling continuous wave trains in order to present the same apparent loudness level to the listener. Likewise other problems may present themselves, such as an interesting form of distortion which the author characterizes as "demodulation distortion."

In considering speech or music it should be realized that the various wave trains tend to produce a modulation envelope, which can be produced either by a tone of constant pitch or by a combination of unrelated frequencies. Usually these modulation envelopes vary from a few cycles-per-second on up into the audible range. If nonlinearity or rectification is present in the audio system, such as might be caused by second harmonic distortion in an amplifier stage, then the envelope components will tend to be demodulated and will appear in the output as a spurious low frequency tone. In the case of a phonograph pickup having a serious ringing resonance, even in the ultrasonic region, the effect of demodulation distortion will be to introduce spurious noise components of a frequency dependent upon the amplitude of the exciting transient and the consequent duration of the ringing envelope. The cure for these effects is, of course, low distortion circuits, however, it is of interest to note that if nonlinearity is present in the loudspeaker system the use of tweeters and woofers with low frequency acoustic cut-off may help to

Concertone maintains its leadership through constant achievement

Concertone's leadership in the field of high fidelity recording is maintained by constantly improving the quality of Concertone magnetic tape recorders

Concertone engineers continually incorporate advancements into the design—thereby keeping consistently ahead of the field. Concertone recorders never become "dated" or outmoded. Now, more than ever before, Concertone is truly the standard of high fidelity performance.

Professional users' net prices begin at \$345.00. Write for literature.



Network
Recorder
NWR-1

"just like being there"



Manufactured by

Berlant Associates

4917 W. Jefferson Blvd., Los Angeles 16, Calif.

Read
RADIO & TELEVISION NEWS
for NEWS of the Industry

LEARN CODE AND THEORY AS LOW AS \$6.95

ECONOMICAL HOME
STUDY
COURSES
PREPARE
YOU TO
PASS AMA-

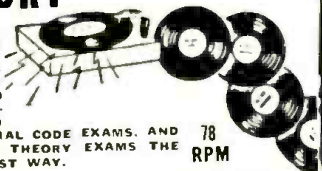

TEUR AND
COMMERCIAL CODE EXAMS. AND 78
AMATEUR THEORY EXAMS THE
EASY, FAST WAY. RPM

3 "AMECO" COURSES AVAILABLE:

#1—NOVICE CODE COURSE. You get and keep 10 recordings (alphabet through 8 W.P.M.). Includes typical F. C. C. type code exams. Free instruction book on learning how to send and receive code the simplest, fastest way; plus charts to check your receiving accuracy plus an album all for the low price of only **\$7.95**

#2—SENIOR CODE COURSE. You get and keep everything given in the Novice Course except that you get 22 recordings (alphabet through 18 W.P.M.) plus typical F. C. C. type code exams for General class and 2nd class commercial telegraph licenses. All this for only **\$12.95**

#3—COMPLETE RADIO THEORY COURSE. A complete, simplified home study theory course in radio, covering the Novice Technician, Conditional General, and Advanced classes—all under one cover—with hundreds of typical F. C. C. type questions to prepare you for license exams. No technical background required. You also get, FREE, one year of consultation and a guide to setting up your ham station. All for the amazingly low **\$6.95** low price of

If your favorite dealer does not yet stock "Ameco" courses, you may order direct. Write for Free information on courses and new "Ameco" transmitter units.

AMERICAN

Electronics Co., Dept. RN-1
1451 Wilkins Ave., N.Y. 59, N.Y.
Tel. No. DAYTON 9-4815

RADIO & TELEVISION NEWS

reduce this effect although other symptoms of distress may occur. In the event of an input signal containing rapidly damped wave trains, such as might be produced by the phase-mixing technique, demodulation-distortion components will tend to occur at a higher rate than in a signal containing wave trains of fairly long duration. Similarly, loudspeaker hangover may represent a greater problem due to the increased intensity of the transients.

In conclusion, it appears that controllable phase-shift mixing in reproducing equipment has a number of unique advantages in securing the best possible sound. This technique can be used for corrective purposes in obtaining greater clarity of reproduction either in the original signal, in the audio equipment being used, or in the acoustic characteristics of the listening environment and appears to achieve some of the desirable characteristics found in live listening or two-channel binaural reproduction. The ability of phase-shift mixing to greatly affect transient-to-sine-wave relationships as well as altering the apparent pitch of asymmetric sounds likewise suggests the need for a re-evaluation of many audio practices, circuits, and reproducing components. In the author's experience it is possible to obtain improved clarity and quality of the reproduction of indifferently good audio equipment through use of the acoustic phase mixing alone, inasmuch as multiple-path sound reproduction tends to allow the phase-sensitive properties of the auditory apparatus to be used by the listener, a situation not found when listening to the direct output of a single radiation source. Similarly, the experimenter will undoubtedly find that phase shift mixing represents one of the most versatile and interesting techniques of varying the characteristics of an audio system.

REFERENCES

1. Villard, O. G., Jr.; "Tunable AF Amplifier," *Electronics*, July, 1949
2. Dome, R. B.; "Wideband Phase Shift Networks," *Electronics*, December, 1946

-30-

PHOTO CREDITS

Page	Credit
36 (Fig. 1)	Technical Appliance Corp.
36 (Right)	Walter L. Schott Co.
37 (Fig. 4), 38 (Fig. 8C), 50, 51, 113, 114, 115, 122, 127	Radio Corporation of America
37 (Fig. 6)	Dark Electronics
46	Emerson Radio & Phonograph Corp.
55	National Broadcasting Corporation
116	Television Technicians Lecture Bureau

ERRATUM

In the circuit diagram of Fig. 7, page 62 of the November issue ("4 Problem Preamps"), a 1 megohm resistor was omitted from the diagram. It should be inserted between the grid of the second half of the 12AX7 tube and ground.

"For those who can hear the difference"
Listen....

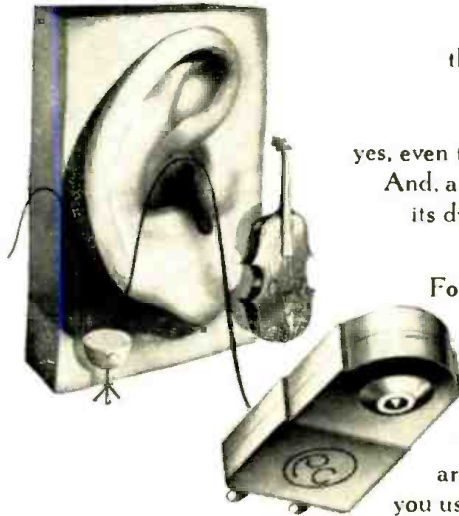

it comes to you in the subtle shading of a piano... in the clean brilliance of violins, the purity of a flute. Your ear detects the sweet mellowness of cellos, the roundness of a clarinet... yes, even the iridescence of clashing cymbals. And, as the symphony swells to crescendo, its dynamic energy adds a flood of color to your musical canvas.

For those who can hear the difference, these are the elusive pleasures that often remain hidden in the grooves of fine recordings. These are the thrilling new listening experiences that are released for your enjoyment when you use quality components by Pickering.

PICKERING and company, incorporated

Pickering High Fidelity Components are available through leading Radio Parts distributors everywhere; detailed literature sent upon request. Address Department C-1



Oceanside, L. I., New York



EVERY RADIOMAN

Can Use These

SERVICE HINTS!

Valuable Manual Yours—FREE!

Every page of "How to Simplify Radio Repairs" is packed with on-the-bench, practical ideas. Contains photos, charts, diagrams—no fluff—no vague theory. In plain every-day language it gives you priceless suggestions—new servicing ideas. You'll use and benefit from the experience of experts. Partial list of contents: How to Localize Trouble; How to Service Amplifiers; How to Test for Distortion; How to Test Audio Circuits; How to Test Speakers; How to Find Faults in Oscillators; How to Test Radio Parts—and it's all yours—FREE! No obligation.





SEND COUPON OR GOVERNMENT POSTCARD FOR YOUR FREE COPY TODAY!

FEILER ENGINEERING CO., Dept. 1-M-3
8026 N. Monticello Ave., Skokie, Ill.
(Suburb of Chicago)

Please RUSH my FREE copy of "How to Simplify Radio Repairs."

Name

Address

City..... Zone..... State.....

New Guaranteed **TUBES** Standard Brands

0A2	\$1.00	6AJ5	\$1.95	812	\$2.75
0A3 VR75	1.10	6AKSW	1.50	813	11.95
0B2	2.00	6AL5W	2.00	814	2.95
0B3 VR90	.95	6AN5	3.65	815	2.90
0C3 VR105	1.00	6AN6	2.75	828	9.95
0D3 VR150	3.00	6AR6	2.25	827CX	9.95
1A3	1.00			828B	1.95
1B22	2.25			830B	2.75
1B23	3.95			833A	34.95
1B24 West	16.50			836	3.45
1B27	14.50			837	1.45
1B32	3.10			845	8.50
1N21B	2.75			8525	19.95
1N22	1.25			860	3.75
1N23	1.00			861	19.95
1N23A	2.25	6AS6	2.30	869B	53.00
1N23B	3.50	6F4	4.25	872A	2.75
1N38	1.50	6J4	6.95	874	1.10
1N40	8.50	6K4	3.50	884	1.60
1N55	2.75	15E		931A	6.50
1F58A	1.25	15R	8.95	954	.33
1N63	2.39	15R	8.95	955	.49
1T5CT	.95	250R	20.00	958A	.69
2C35	25.00	304TH	7.95	959	2.95
2C40	1.49	307A	4.25	961CX	Write
2C43	15.00	307A	7.95	960D	Write
2C44	1.49	307A	4.25	962	2.75
2C52	1.49	350A	5.95	1005	.69
2D21W	2.49	350B	3.95	1006	.90
2E25	2.95	3R8A	1.49	1624	1.45
2E26	3.95	393A	8.95	1626	.39
2K23	39.50	394A	3.95	1627	1.50
2K25	28.50	417A	8.50	1631	.69
2K28	32.00	423A	4.50	2050	1.40
2K29	23.95	434A	19.95	2051	1.10
2K41	110.00	446B	3.50	2051	11.50
2K45	110.00	446B	3.50	5611	8.95
2K48	Write	450TH	44.00	5635	8.95
2X2	.59	454A	10.95	5638	8.95
3A4	.85	605CX	Write	5645	2.00
3A5	.85	701A	4.50	5646	4.30
3AP1	8.95	702A	2.75	5654	2.00
3B23	4.95	703A	4.95	5651	2.75
3B24	4.95	705A	1.50	5652	2.00
3B26	1.50	707B	14.95	5670	2.00
3B24W	7.50	715B	8.95	5672	2.00
3B25	4.95	717A	2.95	5678	2.25
3BP1	4.95	722A	1.95	5686	4.25
3C22	80.00	722A	1.95	5687	4.25
3C24	24G	724A	2.95	5688	2.25
3C27	2.75	723A	16.95	5694	2.60
3C33	14.05	730A	25.00	5702	6.50
3C45	1.10	724B	8.50	5704	4.50
3DP1	3.95	750TL	89.50	5718	Write
3E29	13.95	802	3.95	5726	2.25
3F97	1.95	804	10.95	5744	2.25
3GP1	3.95	805	3.25	619CX	5.95
3HP7	3.95	807	1.95	5749	3.95
4B24	6.95	807W	9.95	5814	3.95
4-125A	25.00	809	2.95	5823	2.95
4X150A	32.50	810	1.0	5844	4.50
4X50A	100.00	811	2.90	5844	1.00
5B1	4.25			6026	2.25
5BP4	4.25			8005	4.95
5C18	35.00	50-15	55.95	8012	1.95
5C22	35.00	50-20	10.00	9001	1.95
5D21	19.95	50-20	10.00	9002	.98
5F7	4.95	50-32	12.50	9003	1.30
5GP1	4.50	12-20	7.50	9009	8.99
5R4GY	1.50	12-32	10.00	9005	1.50
6G50	1.10	100-20	14.50	9006	1.50
6AC7W	2.75			9006	12.25

Vacuum Capacitors

Thousands of other receiving and transmitting types in our stock. If you don't see it listed, ask for it. Send cash with order and save C.O.D. charges.

J. S. H. SALES CO.

Dept. R-17, 7552 Melrose Ave., Los Angeles 46, Calif.

Classified

Rate 50c per word. Minimum 10 words

RADIO ENGINEERING

COMPLETE radio, electronics theory & practice; television; broadcasting; servicing; aviation, marine, police radio, 12 or 18 months. Catalog, Valparaiso Technical Institute, Dept. N, Valparaiso, Ind.

SALE

BC 348R converted for A.C. New condition. F.O.B. \$169.50. W. C. Haigh, 621 Central Ave., East Orange, N. J.

ALL types of Antennas for Amateur and TV. Aluminum tubing. Willard Radcliff, Fostoria, Ohio.

NEW ARN-7 w/inv. I-222, BC-615, many others. Send for list. United Electric, 632 Pelly St., Renton, Wash.

DIAGRAMS Radio, Record Changers, Recorders, 75c; Television with Service Data, \$1.25 up. State manufacturer and model number. Assorted diagrams (no choice) five prewar, or three postwar. \$1.10. Kramer's Radio Service, Dept. B1, 36 Columbus Ave., New York 23, N. Y.

TUBES and equipment bought, sold, and exchanged. For action and a fair deal, write B. N. Gensler, W2LNI, 136 Liberty, N. Y. 6, N. Y.

RECORD Changer parts for leading makes. We ship everywhere. Friend's Wholesale Distrib., 106 N. 6th St., Philadelphia 6, Pa.

TV-FM antennas. All types including UHF. Mounts, accessories. Lowest prices. Wholesale Supply Co., Dept. H, Lunenburg, Mass.

WANTED

AN/APR-1, other "APR," "ARR," "TS," "IE," ARC-1, ARC-3, ART-13, everything surplus; Tubes, Manuals, Laboratory equipment. Describe, price in first letter. Engineering Associates, 434 Patterson Rd., Dayton 9, Ohio.

WANTED: Federal type 101B voice-frequency fingers Signal Corps type TA-3/ET. Box 529, Radio & Television News, 185 N. Wabash Ave., Chicago 1, Ill.

WANTED: Western Electric gray-finished equipment cabinets for 19" panels. Heights of 2'6", 3'6", 7'0" and 7'6". Box 530, Radio & Television News, 185 N. Wabash Ave., Chicago 1, Ill.

WANTED: Top prices paid. Navy Selsyns 10G, 1E, 1CT, 5CT, 5D, 5DG, 5G, 6G, 7G, etc., and BC-348, BC-221, AN/ART-13, AN/ARC-1, AN/ARC-3, RTA-1B, AN/APR-1. Electronic Research, 719 Arch St., Philadelphia.

ALL types of receiving and transmitting tubes. Surplus receivers and transmitters. Williams Electronics Co., 168 Washington St., N. Y. C.

CORRESPONDENCE COURSE

ELECTRONIC Draftsmen—Many needed immediately by Defense Agencies and Contractors. Excellent pay. Pioneer Radio Engineer offers an original and exceptionally high class correspondence course to qualified ambitious young men and women. Details free. C. Roland Leutz, P. O. Box 368, Silver Spring, Maryland.

MISCELLANEOUS

COLOR code chart. Every resistor and capacitor code ever used (total 17), 50c. No stamps. N. S. Brown Associates, 5522 Merrimac, Dallas, Texas.

SPEAKERS repaired, wholesale prices, guaranteed workmanship. Amprite Speaker Service, 70 Vesey St., New York City 7.

RADIOHAMS help Ham. Old RADIONEWS exchange Macao Views. Postbox 354, Macao. Silva exXU88L.

DESIGN, construction, Wheatstone Bridge, \$1.00. Construction data electronic multimeter, \$1.00; particulars free. Technological Developments, 475-P Fifth Ave., New York 17, N. Y.

1000 Kc mounted crystals \$2.95
RCA 100 watt 115 volt line noise filter..... \$1.95
NEW YEAR SPECIALS
20 watt PP 6L6 output transformer, to standard VC, completely shielded upright case..... \$1.95

ZA BAND PASS FILTERS, 60. 90 or 150 cy. each..... \$1.25

OL CAPACITORS
5 MF 236VAC 50.95 16 MF 1500VDC \$6.95
10 MF 236VAC 2.95 2 MF 2000VDC 2.25
14 MF 275VAC 3.49 4 MF 2000VDC 4.50
2 MF 1500VDC 6.9 1 MF 2000VDC 5.50
8 MF 1000VDC 2.95 2 MF 3000VDC 3.95
35 MF 1000VDC 7.50 3000 MF 3V elect. .39
2 MF 1500VDC 1.85 1000 MF 30V ELE. .99
5 HY 300 MA CHOKE, 70 OHMS, 2 KV insulation, new \$2.99. \$25.00

115V POWER SUPPLY KITS 60 CY
A 600VCT 05 MA 6.3V 3A, 5V 2A, 8 HY 100 MA CHOSES 2 CHO. 8X8 MFD 600 VDC OIL CAPACITORS \$5.95
B PLATE TRANSFORMER 740VCT 305 MA, 5V 2A, 8.03V 3A, DUAL 21L TRANSFORMER 4.2 HY 210 MA CHOSES 12 ea. 8X8 MFD 600 VDC OIL CAPACITORS \$12.50

115V POWER TRANSFORMERS 60 CY
5B V Half Wave 3A..... 2.95
6R to 83 V Half Wave 1.5A..... 1.25
300 V Half Wave .02A..... 1.75
435 VCT 145 MA 6.3V 3A, 5V 2A..... 2.95
600 VCT 05 MA 6.3V 3A, 5V 2A..... 3.95
760 VCT 100 MA 5V 3A, 2.5V 10A..... 2.25
740 VCT 185 MA 6.3V 3A, 5V 3A..... 5.95
800 VCT 200 MA 6.3V 3A, 5V 3A..... 5.95
680 VCT 200 MA..... 2.95
740 VCT 305 MA..... 4.95
730-000-0-000-750 VDC 225 MA..... 10.50
3000 VCT 350 MA..... 29.50
5400, 5800, 6200 VCT 110 MA..... 29.50

CHOKES
6 HY 50 MA..... \$ 1.39
9 HY 95 MA..... 1.15
7 HY 125 MA..... 1.49
8 HY 150 MA..... 1.95
10 HY 200 MA..... 2.95
12 HY 250 MA 80 ohm, cased..... 3.95
4-16 HY 200 MA (Swinging)..... 4.99
3 HY 250 MA 15 ohm, cased..... 2.99
5 HY 300 MA 70 ohms..... 2.99
8 HY 400 MA 110 ohms..... 5.99
8 HY 450 MA 80 ohms..... 6.50
6 HY 500 MA 35 ohms..... 7.25
.05 HY 3A 1 ohm..... 0.01
.02 HY 3A 1.5 ohm, cased..... 4.95

115V FILAMENT TRANSFORMERS 60 CY
2.5 VCT 10A, 10 KV Insulation, Cased..... \$4.50
5V 4A 2.5 KV Insulation..... 1.99
5.0 V 3A 0.3 V 1A..... 3.95
5.0 V 12A 2.5 KV Insulation..... 5.95
5.0 VCT 20A 2.5 KV Insulation..... 6.85
5.0 VCT 30A 2.5 KV Insulation..... 7.25
6.3 VCT 3A, 2.5 KV Insulation..... 2.25
6.3 V 0.3 V ea. at 4A..... 2.95
6.3 VCT 6A, 2.5 KV Insulation..... 3.15
10 VCT 10A, 2.5 KV Insulation..... 6.00
Dual 2.5V 1 Amp..... 1.95
34-41V 1A..... 1.49

IN34 GERMANIUM DIODES
10 for \$3.95, 100 for \$35.00

HEARING AID TESTER
DYSONIC hearing aid tester, leak type 503, 505 aubin; hearing aid tubes, batteries, cords etc. Complete with G.E. 3" SQUARE METRIC (0-1MA) emf Travel bakelite panel, tube socket etc. Less portable case..... Only \$12.95

SIGMA SENSITIVE 5 Prong Plug In relay, point-to-point coil 1000 ohms D.C. operates on 2-4 MA SPDT contacts. Ideal for use with electric eye, control of model hobby equipment, etc. May be used directly in plate circuit of amplifiers, etc. Removable dust cover permits finer adjustment of contacts. \$2.95. \$25.00

POCKET MULTIMETER
SUPREME type 842 pocket multimeter 5000 ohm/volt 3" meter (Manufactured by TITUMPI, SU-PHESE) 24 AC/DC ranges measures up to 1500VDC, complete with test leads, batteries & 80 day guarantee..... Price each \$14.95

ZA GLIDE PATH RECEIVER, NEW, BLACK CRACKLE ALUMINUM CASE 6"x7"x12" complete with shock mount, (3) 6C6 tubes, resistors, capacitors, etc. Ideal for building test equipment, mobile transmitter, etc..... \$3.95

TV COLOR ADAPTER converts sweep frequencies of present TV sets to requirements of color sweeps to permit viewing on black and white receivers. Unit comes housed in attractive brown cabinet, completely wind ready to operate, including cables and simple instructions. \$1.79 each. \$.99

FUSES
2A 3AG 100 2.49 30A 4AG 100 2.45
10A 3AG-silo-100 3.95 35A 4AG 100 2.75
10A 4AG 100 2.45 40A 4AG 100 2.75
15A 4AG 100 2.45 50A B 100 1.99
20A 4AG 100/2.45 100A B 100 1.99

TUBES 2E24 \$2.49 304TL \$6.95
3E29 9.95 872A 3.95

POLY TECH
Dept. A-3, 919 Dawson St., New York 59, N. Y.
Send for Bulletin
Murray Hill 6-2650

Live Music vs. Recorded Music

excerpt from Wall Street Journal
front page, Oct. 30, 1952

"... The Audak Co., has on hand one of Toscanini's NBC violinists and a cellist from the New York Opera, both playing instruments made by the renowned Stradivari. Intermittently they put down their bows—and the music is carried on by a phonograph recording made by the same musicians. *The switch, to most listeners, is not discernible...*" etc.

Thousands waited in line for a chance to hear this daring, first-time-in-music-history, performance. The audience could not tell which was playing, the artists, or the AUDAX CHROMATIC DIAMOND reproducer.

Hear, for yourself, how near to perfection the AUDAX CHROMATIC DIAMOND pickup plays the modern discs.

Convert your POLYPHASE with a replaceable Audax CHROMATIC Diamond Stylus, now available at your dealer.

AUDAK COMPANY
500 Fifth Avenue Dept. C New York 36
Fine music reproducers for over 25 years

GET INTO ONE OF THESE GREATER OPPORTUNITY FIELDS

Electricity or Radio-Television

COYNE

OLDEST, BEST EQUIPPED SCHOOL OF ITS KIND IN U. S.

Come to the Great shops of Coyne in Chicago. Get practical training in TELEVISION—RADIO—ELECTRICITY—ELECTRONICS—vital in Defense Program. Prepare now for a better job in Industry or higher rating in Armed Forces.

Approved for Veterans—finance plan—enroll now, pay most of tuition later. Part time employment service while training if needed. Special tuition plan for men of Draft Age.

FREE BOOK Clip coupon for Big Free Illustrated Book. No obligation. No salesman will call. Act NOW.

B. W. Cooke, President
A TECHNICAL TRADE INSTITUTE CHARTERED NOT FOR PROFIT Established 1899 500 S. Paulina, Chicago
ELECTRICITY ★ TELEVISION
RADIO ★ REFRIGERATION ★ ELECTRONICS

B. W. COOKE, Pres.
COYNE School
500 S. Paulina St., Chicago 12, Ill. Dept. 13-85H
Send FREE BOOK and details on:

RADIO-TELEVISION ELECTRICITY

NAME.....
ADDRESS.....
CITY..... STATE.....



DEDICATED TO YOU!

This great new **EICO**
FACTORY... these **NEWEST**
EICO INSTRUMENTS...

YOU made them possible with your
CONFIDENCE in EICO. We pledge to strive
 with all our power, product-wise and
 service-wise, to continue to merit your
 trust in us.

Harry R. Ashley
 President



6 NEW V-O-M KITS and Instruments

FOR LABORATORY PRECISION AT LOWEST COST



EICO New Model 536 —
 1000 Ohms/Volt Multimeter
 Wired \$14.90. KIT \$12.90.

- 31 full scale ranges!
- DC/AC Volts: Zero to 1, 5, 10, 50, 100, 500, 5000
- DC/AC Current: 0.1 ma, 10 ma, 0.1 A, 1 Amp.
- Ohms: 0-500, 100K, 1 meg.
- 6 DB Ranges: 20 to 69.
- Large 3" 400 ua meter movement.
- High-impact Bakelite case. 6 1/2" x 3 1/2" x 2 1/2".

EICO New Model 526 1000 Ohms/Volt Multi-
 meter KIT \$13.90. Wired \$16.90. As above, with 1%
 precision resistors.



EICO New Model 566 1000 Ohms/Volt Multimeter KIT
 \$14.90. Wired \$18.95. Ranges: same as Model 536 (left), plus
 7 output voltages. Large 4 1/2" 400 ua meter movement.

EICO New Model 556 1000 Ohms/Volt Multimeter KIT
 \$16.90. Wired \$23.50. Ranges: same as Model 536 (left), plus
 7 output voltages. Large 4 1/2" 400 ua meter movement and 1%
 precision resistors.

Compare these value-crammed EICO V-O-Ms with
 any others at any price — at your local jobber — and
 SAVE! Write NOW for FREE newest Catalog L-R A

EICO New Model 565
 20,000 Ohms/Volt Multimeter KIT \$24.95.
 Wired \$29.95.

- 31 full scale ranges!
- DC AC/Output Volts: 0-2.5, 10, 50, 250, 1000, 5000
- DC Current: 0-100 ua; 10, 100, 500 ma, 10 Amp.
- Ohms: 0-2000, 200K, 20 meg.
- 5 DB Ranges: 12 to 55.
- Large 4 1/2" 50 ua meter movement.
- High-impact Bakelite case. 6 1/2" x 5 1/2" x 3 1/2".

EICO New Model 555 20,000 Ohms/
 Volt Multimeter KIT \$29.95. Wired
 \$34.95. As above, with 1% precision res-
 istors.

ONLY **EICO** GIVES YOU ALL
 10 **EICO** NOMICAL FEATURES

- Laboratory Precision • Lowest Cost • Life-time Dependability • Speedy Operation
- Rugged Construction • Quality Components • Latest Engineering • Super-Simplified Assembly & Use Instructions • Laboratory-Styled Appearance • Exclusive EICO Make Good Guarantee.



Prices slightly higher on West Coast. Due to unstable conditions, prices and specifications are subject to change without notice.

ELECTRONIC INSTRUMENT CO., Inc. 84 Withers Street, Brooklyn 11, New York

UHF*



*All UHF channels...
for all TV sets*

MALLORY UHF CONVERTER

The Mallory UHF converter is right for *all* your TV customers because it can be used with *any* TV set... in *any* UHF broadcast area. And it's easy to install—no adjustments or connections to make in the TV set... just connect power lines and antenna leads.

These Mallory features mean real customer satisfaction... real sales for you in the new UHF market—

- Reception of all UHF channels
- No sacrifice of VHF channels
- Built-in UHF antenna
- High quality picture definition
- Fast, easy installation

No larger than a small portable radio, the Mallory UHF converter is precision-built for long, trouble-free service. Get complete details today on the Mallory UHF converter from your Mallory distributor.

P. R. MALLORY & CO. Inc.
MALLORY CAPACITORS... CONTROLS... VIBRATORS...
 SWITCHES... RESISTORS... RECTIFIERS...
 VIBRAPACK® POWER SUPPLIES... FILTERS...
Reg. U.S. Pat. Off.

APPROVED PRECISION PRODUCTS

P. R. MALLORY & CO., Inc., INDIANAPOLIS 6, INDIANA

*Make Sure...
Make it Mallory*